



**VIVALDI**

**2.1**

CATALOGO LINEA MULTIMEDIALE  
MULTIMEDIA LINE CATALOGUE



**VIVALDI**

Telemaco C4IO	9-15 / 18-19 16
Vivaldi App	23-25
KEYSOL multimedia WiFi and Bluetooth player	26-27
KEYSOL-DIN. Multisource universal WiFi player DIN rail	28-29
KEYSOL-15S. Active player 15+15W with WiFi and Bluetooth	32-33
P40SL. Multimedia amplifier 40+40W RMS DIN rail, with integrated Keysol multi-source WiFi player	34-35
KEYROUND16AF. WiFi built-in speaker kit with integrated Keysol multi-source player	38-39
KEOPE.S40WiFi, KEOPE.S80WiFi, KEOPE.SOUNDB80WiFi, KEOPE.SOUNDB160WiFi, KEOPE.HP60WiFi, KEOPE.M250WiFi design active speakers, on shelf with integrated Keysol multi-source WiFi player	40-42
KBOX multimedia amplifier Bluetooth and WiFi with integrated player	46
KEYROCK20A. Active speaker, HiFi garden, with integrated Keysol multi-source WiFi player	47
KEYGREEN16A. Active speaker, HiFi garden, with integrated Keysol multi-source WiFi player	48
KEYZEN315A, KEYZEN510A, KEYZEN730A. Active speakers, HiFi garden, with integrated Keysol multi-source WiFi player	49-51
P30S. Multimedia amplifier 30+30W RMS DIN rail, with integrated Keysol multi-source WiFi player	56-57 / 60-63
P80S. 80+80W RMS multimedia amplifier DIN rail, with integrated Keysol multi-source WiFi player	58-59 / 64-69
MATRIX6. Matrix 6 inputs + 1 source, 6 outputs, with DSP, DIN rail and integrated Multisource WiFi player Keysol	70-71 / 76-79
E30S. Power expansion 30+30W RMS DIN rail	72-73
E80S. Power expansion 80+80W RMS DIN rail	74-75
A25SBTC. 25+25W stereo bluetooth amplifier for Hospitality and Home solutions, DIN rail	82-83 / 86-87
MA5060BTK, MA5120BTK, MA5240BTK. Amplified mixer with integrated sources and APP for multiroom (WiFi, radio FM, MP3 USB, SD, Bluetooth, LAN)	94
MZ6120BTK, MZ6240BTK, MZ6350BTK, MZ6500BTK. Multizone amplified mixer with integrated sources and APP, independent volumes (WiFi, radio FM, MP3 USB, SD, Bluetooth, LAN)	95
MS6120BTK, MS6240BTK. Multizone matrices with integrated sources and APP, music and independent volumes (WiFi, radio FM, MP3 USB, SD, Bluetooth, LAN)	96
BM6, BS6, CR1. Microphone bases and zone control	97
PMA2120. PMA2240. PMA2500. 100V stereo power amps	98
PSA300MK2. PSA500MK2. PS1000. Stereo power endings 4-16Ω	99-100
PS1000. PS3000. Stereo power endings 4-16Ω	100
PSA4300. PSA4500. PSA6500. PSA8500. 4-8Ω stereo multichannel power amps	101-102
DA8. Distributor of audio signals DIN rail	102
GRM1. Recorder, message generator with built-in microphone DIN rail	103
Speakers and accessories	84-85 / 104-149
Subwoofers	150-152
Alphabetic index	153-157



Telemaco C4IO	9-15 / 18-19 16
Vivaldi App	23-25
KEYSOL mediacenter multimediale WiFi e Bluetooth	26-27
KEYSOL-DIN. Player WiFi multisorgente universale da barra DIN	28-29
KEYSOL-15S. Player attivo 15+15W con WiFi e Bluetooth	32-33
P40SL. Amplificatore multimediale 40+40W RMS da barra DIN, con player WiFi multisorgente Keysol integrato	34-35
KEYROUND16AF. Kit diffusori da incasso WiFi con player multisorgente Keysol integrato	38-39
KEOPE.S40WiFi, KEOPE.S80WiFi, KEOPE.SOUNDB80WiFi, KEOPE.SOUNDB160WiFi, KEOPE.HP60WiFi, KEOPE.M250WiFi diffusori attivi di design, da appoggio, con player WiFi multisorgente Keysol integrato	40-42
KBOX amplificatore multimediale Bluetooth e WiFi con player integrato	46
KEYROCK20A Diffusore attivo, da giardino HiFi, con player WiFi multisorgente Keysol integrato	47
KEYGREEN16A Diffusore attivo, da giardino HiFi, con player WiFi multisorgente Keysol integrato	48
KEYZEN315A, KEYZEN510A, KEYZEN730A Diffusori attivi, di potenza HiFi, con player WiFi multisorgente Keysol integrato	49-51
P30S. Amplificatore multimediale 30+30W RMS da barra DIN, con player WiFi multisorgente Keysol integrato	56-57 / 60-63
P80S. Amplificatore multimediale 80+80W RMS da barra DIN, con player WiFi multisorgente Keysol integrato	58-59 / 64-69
MATRIX6. Matrice 6 ingressi + 1 sorgente, 6 uscite, con DSP, da barra DIN e player WiFi multisorgente Keysol integrato	70-71 / 76-79
E30S. Espansione di potenza 30+30W RMS da barra DIN	72-73
E80S. Espansione di potenza 80+80W RMS da barra DIN	74-75
A25SBTC. Amplificatore bluetooth stereo 25+25W per soluzioni Hospitality e Home, da barra DIN	82-83 / 86-87
MA5060BTK, MA5120BTK, MA5240BTK. Mixer amplificati con sorgenti integrate & APP per funzione multiroom (WiFi, radio FM, MP3 USB, SD, Bluetooth, LAN)	94
MZ6120BTK, MZ6240BTK, MZ6350BTK, MZ6500BTK. Mixer amplificati multizona con sorgenti integrate & APP, volumi indipendenti (WiFi, radio FM, MP3 USB, SD, Bluetooth, LAN)	95
MS6120BTK, MS6240BTK. Matrici amplificate multizona con sorgenti integrate & APP, musiche e volumi indipendenti (WiFi, radio FM, MP3 USB, SD, Bluetooth, LAN)	96
BM6, BS6, CR1. Basi microfoniche e controlli di zona	97
PMA2120. PMA2240. PMA2500. Finali di potenza stereo 100V	98
PSA300MK2. PSA500MK2. PS1000. Finali di potenza stereo 4-16Ω	99-100
PS1000. PS3000 Finali di potenza stereo 4-16Ω	100
PSA4300. PSA4500. PSA6500. PSA8500. Finali di potenza multicanale stereo 4-8Ω	101-102
DA8. Distributore di segnali audio da barra DIN	102
GRM1. Registratore, generatore di messaggi con microfono integrato da barra DIN	103
Diffusori e accessori	84-85 / 104-149
Subwoofer	150-152
Indice alfabetico	153-157





Sistemi all-in-one per

# Residenziale

player multimediale  
con APP

Il soggiorno, la cucina ma anche il garage o la cantina.

Facile, lo porti a casa ed il gioco è fatto.

Sarai tu a gestire tutto:

le radio da tutto il mondo, gli audiolibri, la musica,

i vari podcast. Associa i diffusori con la nostra Vivaldi app,  
regola il volume buon ascolto.

## **Sound with culture - multimedia residential system**

*The living room, the kitchen but also the garage or the cellar.*

*Easy, you take it home and it's done.*

*You manage everything:*

*radios from all over the world, audiobooks, music,*

*several podcasts. Pair your speakers with our Vivaldi app,*

*adjust the volume and enjoy the listening.*







# Telemaco

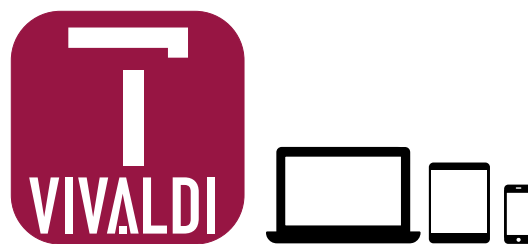

Telemaco il nuovissimo multiroom integrato da 6 zone espandibile fino a 12. Perfetto per tutte le abitazioni. Compatto, 6 moduli DIN, implementa 4 player multisorgente (YouTube, WebRadio, Spotify, NAS...) e 6 amplificatori audio per collegare diffusori 8  $\Omega$  a bassa impedenza (imp. min. 4 $\Omega$ ). Dotato di 3 ingressi stereo per sorgenti esterne (PC, giradischi, TV, CD, Playstation, ...) con uscite preamplificate per il collegamento di espansioni di potenza, diffusori o subwoofer attivi, l'integrazione domotica avviene con connettività KNX o tramite protocolli MQTT e REST. Abbinando 2 TELEMACO è possibile realizzare un sistema di distribuzione audio a 12 zone, con 6 player multisorgente indipendenti (YouTube, WebRadio, Spotify, NAS...) e 6 ingressi per sorgenti esterne. D'ora in poi, la musica preferita di ognuno, in qualunque stanza e in qualsiasi momento, con un semplice tocco. Telemaco, il sistema evoluto per musica, qualsiasi musica, dalle webradio del mondo ai più moderni servizi di streaming. Progettato per riprodurre audio di qualità con semplicità, grazie ad un sistema intelligente di componenti audio HiFi. Gestito da una innovativa APP, facile da utilizzare, gratuita, scaricabile dagli store Apple e Google, oppure da PC tramite software scaricabile dal nostro sito.



Telemaco the brand new integrated multiroom with 6 zones expandable up to 12. Perfect for all homes. Compact, 6 DIN modules, implements 4 multi-source players (YouTube, WebRadio, Spotify, NAS...) and 6 audio amplifiers to connect low impedance 8  $\Omega$  loudspeakers (imp. min. 4 $\Omega$ ). Equipped with 3 stereo inputs for external sources (PC, turntable, TV, CD, Playstation, ...) with preamplified outputs for connecting power expansions, loudspeakers or active subwoofers, home automation integration takes place with KNX connectivity or via MQTT protocols and REST. By combining 2 TELEMACOs it is possible to create an audio distribution system with 12 zones, with 6 independent multi-source players (YouTube, WebRadio, Spotify, NAS...) and 6 inputs for external sources. From now on, everyone's favorite music, in any room and at any time, with a simple touch. Telemaco, the advanced system for music, any music, from world web radios to the most modern streaming services. Designed to reproduce quality audio with ease, thanks to an intelligent system of HiFi audio components. Managed by an innovative APP, easy to use, free, downloadable from the Apple and Google stores, or from a PC using software downloadable from our website.

**1**  
dispositivo  
device

**2**  
diffusori per zona  
speaker each zone

**1** rete internet  
network

**1** App

**4**  
player multisorgente  
multisource players

**1**  
alimentatore  
power supply

# Multiroom audio integrato

## 6-12 zone



INTERNET

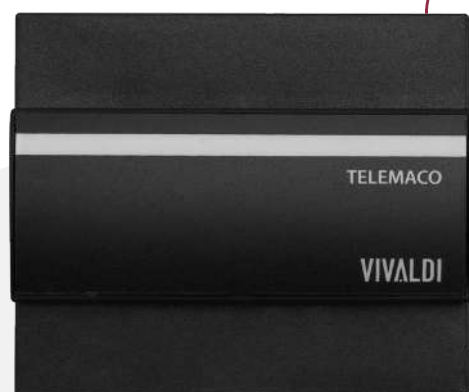

Soggiorno



Cucina



Bagno



Piscina



Cameretta

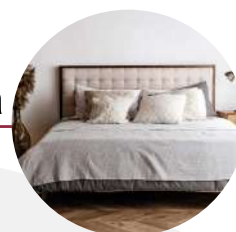

Camera



Cabina armadio

E30S

# TELEMACO

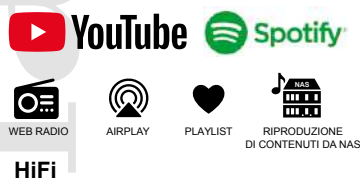
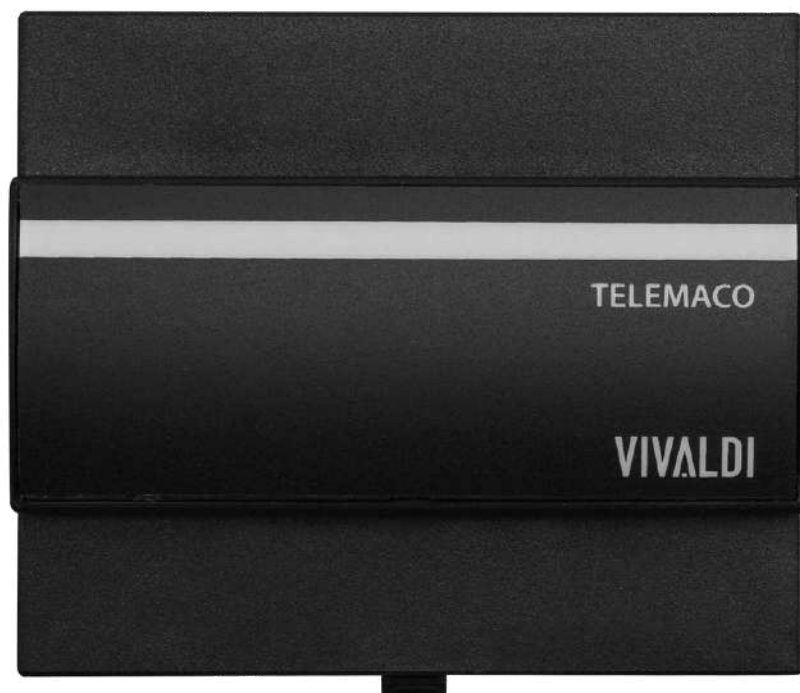

## CAMPI APPLICATIVI application fields



### TELEMACO

Sistema multiroom all-in-one integrato, completo di amplificazione e sorgenti audio multimediali compatibile KNX, MQTT, REST.API e domotiche terze. Gestione e supervisione tramite APP Telemaco disponibile per iOS & Android.

Sistema espandibile a 6 player a 12 zone, abbinando 2 Telemaco.

#### Ingressi:

- 3 ingressi stereo sbilanciati livello linea 0dB
- Connettore alimentazione
- Micro SD

#### Uscite:

- 6 uscite amplificate (6x20W @ 4Ω)
- 6 uscite preamplificate bilanciate livello linea per ampliare il numero di diffusori o la potenza di zona tramite amplificatori esterni (E30S, E80S, finali Vivaldi serie PMA, finali Vivaldi serie PSA, subwoofer attivi Vivaldi, diffusori attivi Vivaldi)
- Diffusori collegabili 8Ω per ogni uscita, impedenza

Integrated all-in-one multiroom system, complete with amplification and multimedia audio sources compatible with KNX, MQTT, REST.API and home automation third. Management and supervision via Telemaco APP available for iOS & Android.

System expandable to 6 players to 12 zones, combining 2 Telemaco.

#### Inputs:

- 3 stereo inputs unbalanced line level 0db
- Power supply connector
- Micro SD

#### Outputs:

- 6 amplified outputs (6x20W @ 4Ω)
- 6 line level balanced preamp outputs to expand the number of speakers or power zone via external amplifiers (E30S, E80S, Vivaldi PMA, Vivaldi PSA series power amplifiers, Vivaldi active subwoofers, Vivaldi active speakers)- 8 Ω speakers for each output,



minima 4Ω

**Connettività:**

- Connettore KNX diretto
- Connettore RJ45 LAN 10/100

**Player / Utenti:**

- 4 Player integrati con i servizi
- Spotify Connect
- Airplay
- Webradio
- NAS
- Playlist
- Musica locale (Android)
- YouTube
- AUX

**Altro:**

- Creazione Playlist e accesso rapido
- Webradio preferite con accesso rapido
- Funzionalità Preset con accesso rapido
- Funzionalità Campanello con scelta per singola zona non disturbare
- Webpage di configurazione
- Personalizzazione nomi Player/Utenti, ingressi AUX e uscite zone
- Shortcut accesso al player/utente
- Impostazione zone stereo (per un massimo di 3 zone stereo o combinazione mono/stereo)
- Possibilità di accoppiare due dispositivi per la creazione di un unico sistema da 12 zone, 6 ingressi AUX, 6 player (massimo 6 zone stereo o combinazioni mono/stereo)
- App di controllo dedicata (Vivaldi Telemaco)
- API di controllo supportate: KNX, MQTT, REST (con access token)
- Pulsante a sfioramento multifunzione sul frontale (reset DHCP, reset di fabbrica, IP statico...)
- Barra a LED di stato multicolore.
- Risparmio energetico amplificatori
- Aggiornamenti OTA

**Opzione:**

C4IO pulsanti programmabili a 4 ingressi. Tasti multifunzione a pressione breve o lunga per associare due funzioni ad ogni singolo pulsante. I primi due ingressi (pulsanti) possono essere utilizzati con encoder rotativo (TVE da ordinare a parte) per il controllo di volume.

**Funzioni assegnabili ai pulsanti C4IO:**

- Incremento / decremento volume
- Ingressi / uscite
- Attivazione mute e disattivazione
- Richiamo preset
- Avanti/indietro traccia player
- Stop
- Play / Pausa player
- Play USB (priorità)

**Cavi da utilizzare:**

- cavo di sistema MICRO2.50 per gli ingressi analogici e le uscite preout
- pialtina rosso-nera 2x0,75, o equivalente, per il collegamento degli altoparlanti e l'alimentazione
- cavo LAN cat5e/cat6
- cavo bus KNX

Dimensioni (LxHxP): 106x91x62mm, 6 moduli DIN.  
 Peso: 0,250 kg  
 Alimentazione : 24Vcc / 150W max (AL6B)

minimum impedance 4 Ω

**Connectivity:**

- KNX connector embedded
- RJ45 LAN 10/100 connector

**Player / Users:**

- 4 Players integrated with services
- Spotify Connect
- YouTube
- Webradio
- Airplay
- NAS
- Local music (Android)
- Playlist
- AUX

**Other:**

- Playlist creation and quick access
- Favorite webradio with fast access
- Preset functionality with quick access
- Function Doorbell with choice for single zone do not disturb
- Webpage configuration
- Customizing Player/User names, AUX inputs and zone outputs
- Shortcut access to player/user
- Stereo zone setting (for up to 3 stereo zones or mono/stereo combination)
- Possibility to pair two devices to create a single 12-zones system, 6 AUX inputs, 6 players (maximum 6 stereo zones or mono/stereo combinations)
- Dedicated control app (Vivaldi Telemaco)
- Supported control APIs: KNX, MQTT, REST (with access token)
- Multi-function touch button on the front (DHCP reset, factory reset, static IP...)
- Multi-colored LED status bar.
- Energy saving amplifiers
- OTA updates

**Option:**

C4IO programmable buttons with 4 inputs. Short or long press multifunction keys to associate two functions to each single button. The first two inputs (buttons) can be used with rotary encoder (TVE to be ordered separately) for volume control.

**Functions assignable to the buttons C4IO:**

- Increase / decrease in volume
- Inputs / outputs
- Mute and deactivation switch
- Preset recall
- Forward/backward track player
- Stop
- Play / Pause player
- Play USB (priority)

**Cables to be used:**

- MICRO2.50 system cable for analog inputs and preout outputs
- Red-black cable 2x0,75 or equivalent for speaker connection and power supply
- LAN cable cat5e/cat6
- KNX bus cable

Dimensions (WxHxD): 106x91x62mm, 6 DIN modules.  
 Weight: 0,250 kg  
 Power supply : 24vdc / 150W max (AL6B)



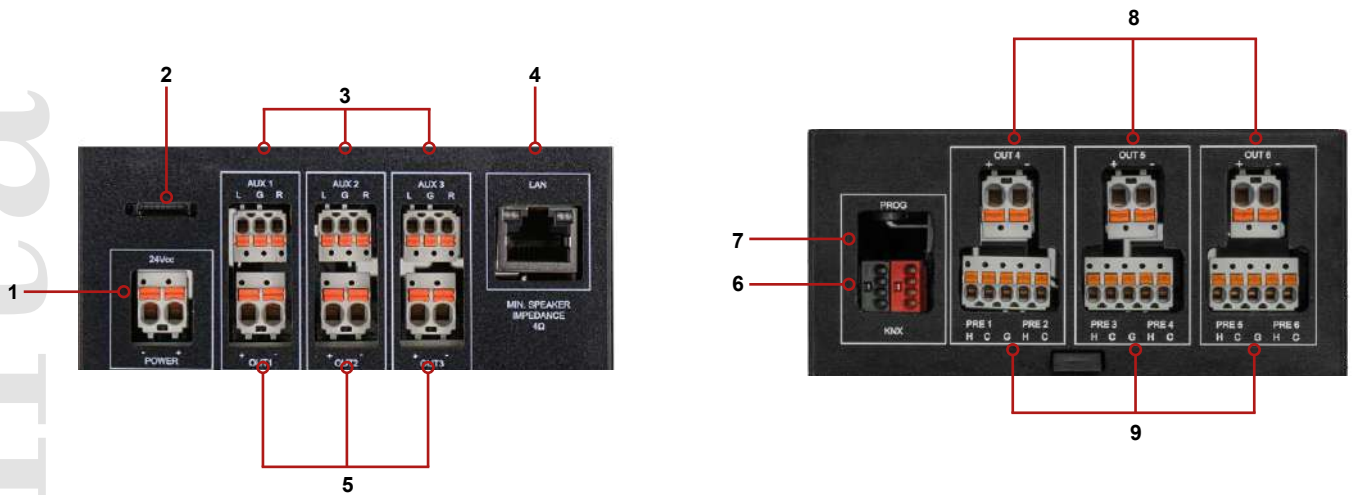

- 1** Ingresso alimentazione 24Vdc  
24Vdc power input
- 2** Slot per MicroSD Card  
MicroSD Card slot
- 3** Ingressi ausiliari stereo sbilanciati  
Unbalanced stereo auxiliary inputs
- 4** Porta RJ45 per connessione a rete LAN  
RJ45 port for LAN network connection

- 5** Uscite amplificate per collegamento diffusori zone 1-2-3  
Amplified outputs for connecting zone 1-2-3 loudspeakers
- 6** Connettore bus KNX  
KNX bus connector
- 7** Pulsante programmazione indirizzo fisico KNX  
KNX physical address programming button

- 8** Uscite amplificate per collegamento diffusori zone 4-5-6  
Amplified outputs for connecting zone 4-5-6 loudspeakers
- 9** Uscite pre bilanciate per espansioni di potenza  
Pre balanced outputs for power expansions

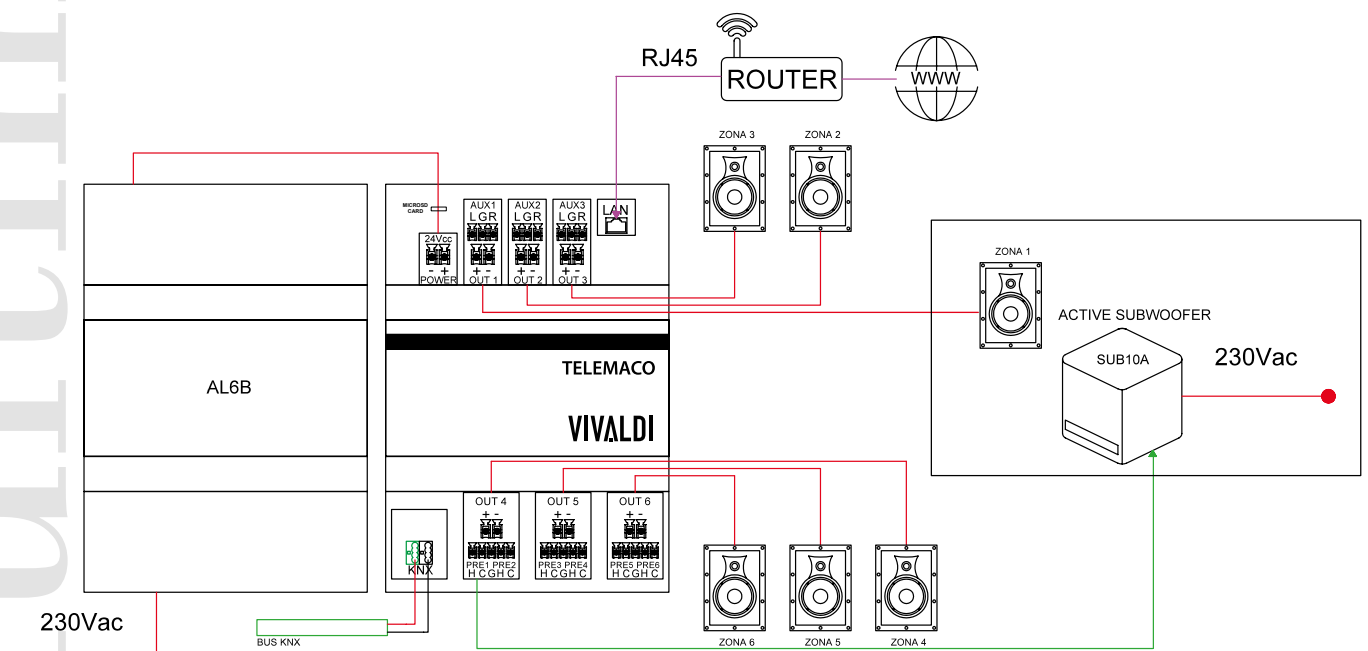

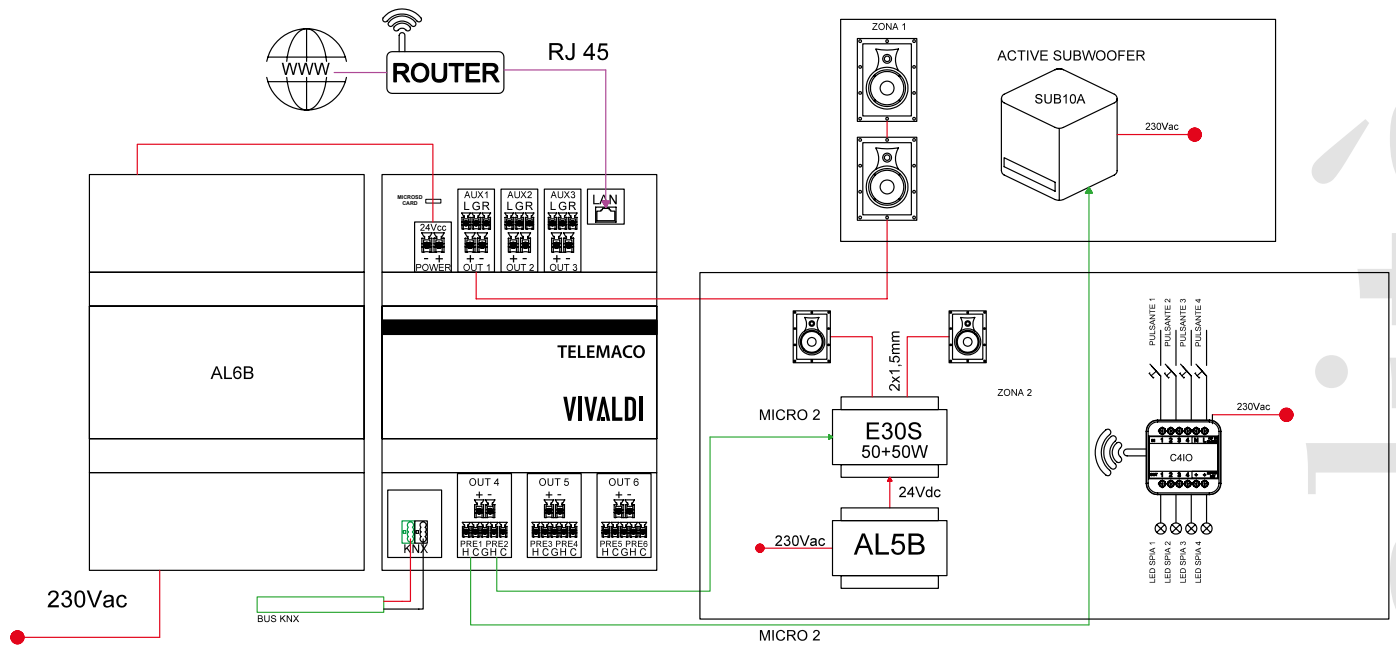

Il modulo C4IO gestisce 4 pulsanti da 2 funzioni ciascuna (pressione lunga e breve), è alimentato in 220V e per comunicare con Telemaco utilizza la rete WiFi dell'edificio

The C4IO module manages 4 buttons with 2 functions each (long and short press), is fully powered in 220V and to communicate with Telemaco uses the WiFi network of the building.

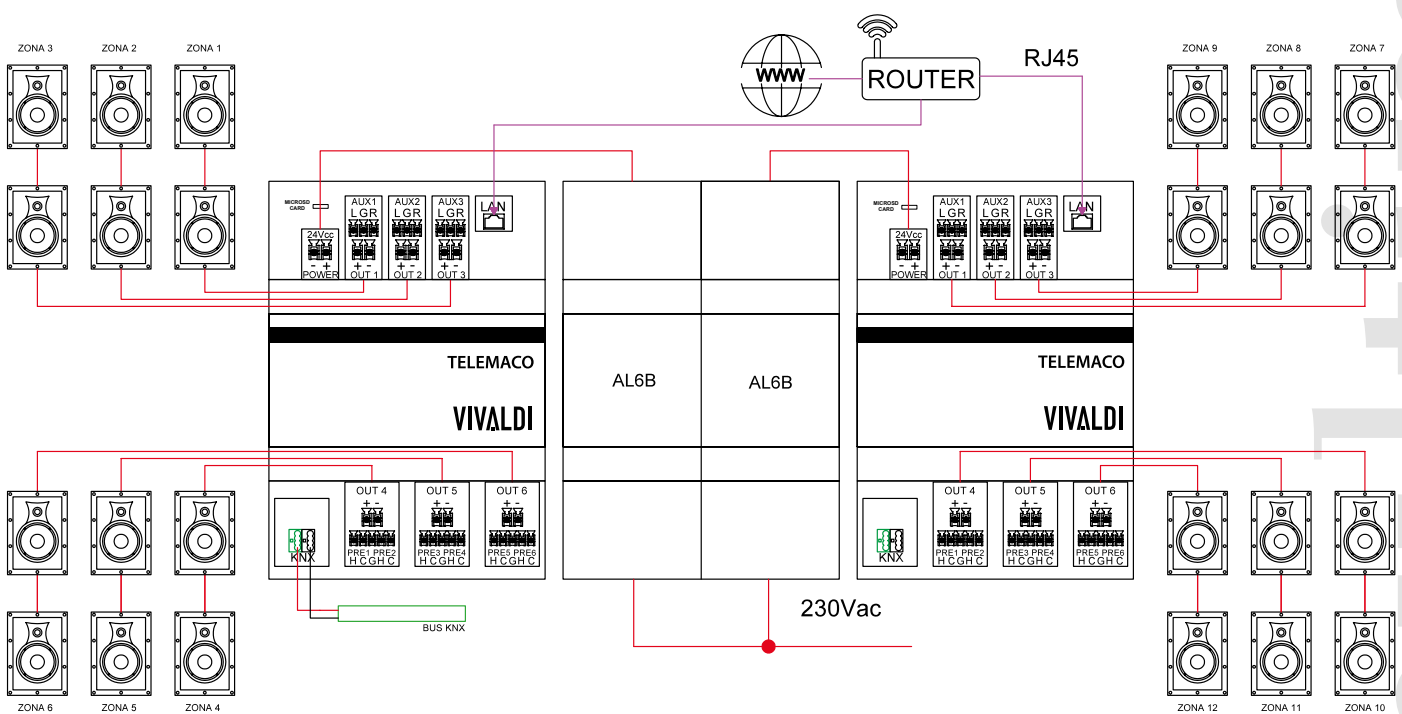



## C4IO

### Interfaccia remota di comando per dispositivi P30S, P80S, MATRIX6, TELEMACO.

Connettività WiFi.  
Webpage di configurazione.

### INGRESSI

Quattro ingressi a pulsante con funzioni assegnabili tramite programmazione da webpage.  
Pulsanti multifunzione (pressione breve e lunga) per associare due funzioni ad ogni singolo ingresso.  
I primi due ingressi possono essere utilizzati con encoder rotativo (accessorio TVE) per il controllo di volume tramite manopola.

### Funzioni in abbinamento a P30S, P80S:

Incremento / decremento volume ingressi / uscite  
Attivazione muto e disattivazione  
Richiamo preset  
Avanti/indietro traccia player  
Stop  
Play / Pausa player  
Controllo volume separato canale sinistro e destro  
Play USB (priorità)

### Funzioni in abbinamento a MATRIX6:

Incremento / decremento volume ingressi / uscite  
Attivazione muto e disattivazione  
Richiamo preset  
Avanti/indietro traccia player  
Stop  
Play / Pausa player  
Play USB (priorità)

### Funzioni in abbinamento a TELEMACO:

Incremento / decremento volume ingressi / uscite  
Attivazione muto e disattivazione  
Richiamo preset  
Avanti/indietro traccia player  
Stop  
Play / Pausa player

### USCITE

Quattro uscite per collegamento di LED 12V. 3 modalità luce: fissa, lampeggio lento, lampeggio veloce. Per le seguenti funzioni:  
Stato di muto player, ingressi e uscite  
Stato di riproduzione player  
Stato della connessione WiFi

Feedback pressione tasto  
Alimentazione 110 - 230Vac.  
Dimensioni (LxHxP) 44x44x18 mm.  
Peso: 0,50Kg



Esempio di pulsanti programmabili da C4IO.  
Example of buttons programmable by C4IO.

### Remote control interface for P30S, P80S, MATRIX6, TELEMACO.

WiFi connectivity.  
Webpage configuration.

### INPUTS

Four button inputs with functions assignable via webpage programming.  
Multi-function buttons (short and long press) to associate two functions to each single input.  
The first two inputs can be used with rotary encoder (TVE) for volume control via knob.

### Functions in combination with P30S, P80S:

Increment / decreasing volume inputs/ outputs  
Mute and deactivation switch  
Preset recall  
Forward/backward track player  
Stop  
Play / Pause player  
Left and right channel separate volume control  
Play USB (priority)

### Functions in conjunction with MATRIX6:

Increment / decreasing volume inputs/ outputs  
Mute and deactivation switch  
Preset recall  
Forward/backward track player  
Stop  
Play / Pause player  
Play USB (priority)

### Functions in conjunction with TELEMACO:

Increment / decreasing volume inputs/ outputs  
Mute and deactivation switch  
Preset recall  
Forward/backward track player  
Stop  
Play / Pause player

### OUTPUTS

Four outputs for 12V LED connection. 3 light modes: fixed, slow flashing, fast flashing. For the following functions:  
Mute player status, inputs and outputs  
Player playback status  
WiFi connection status

Feedback button press  
Power supply 110 - 230vac.  
Dimensions (WxHxD) 44x44x18 mm.  
Weight: 0,50kg



## TVE

Encoder per il controllo di volume, da associare al dispositivo C4IO. Fornito su tappo cieco. L'encoder è equipaggiato con un pulsante, il quale può essere associato ad una funzione di C4IO.

Encoder for volume control, to be associated with the device C4IO. Supplied on blind cap. The encoder is equipped with a button, which can be associated with a function of C4IO.



## AL6B

Alimentatore per 1 Telemaco. Da barra DIN (6 moduli). Input 100-240Vac 50Hz 1,8A. Output 24 Vdc 6,25A, 150W. Colore nero. Dimensioni (LxHxP) 103x58x90 mm. Peso 0,35Kg.

DIN rail power supply (56modules). Input 220-240 Vac 50Hz 1,8A. Output 24 Vdc 6,25A, 150W. Black colour. Size 103x58x90 mm (WxHxD). Weight 0,35 Kg.



## MICRO2

Cavo microfonico 3mm (diametro esterno). Disponibile in matasse da mt 50/100/200.

Mic balanced cable 3mm (external size). Available in 50/100/200 skeins.





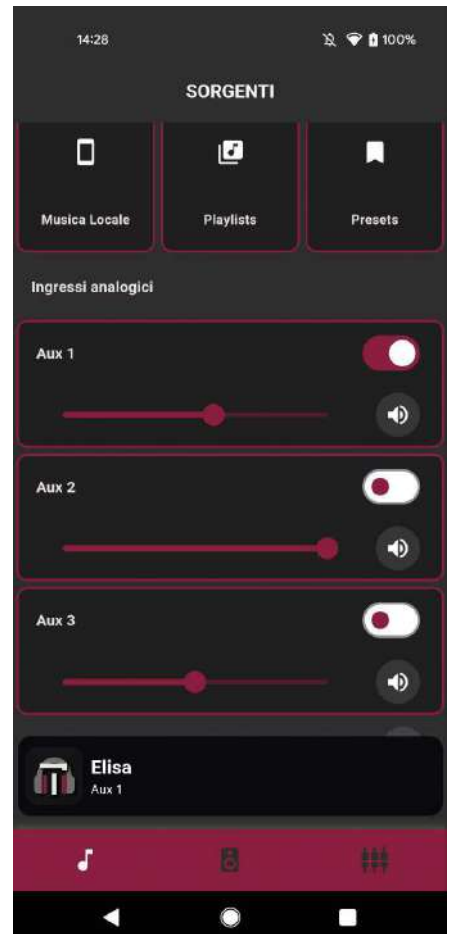
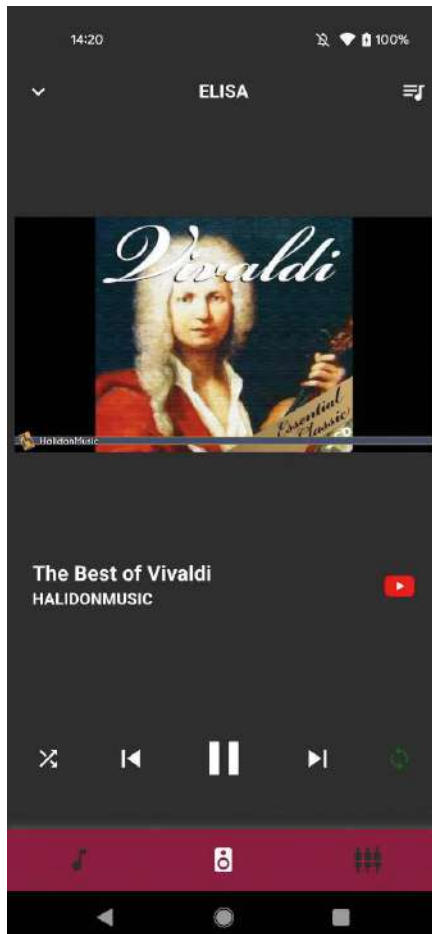
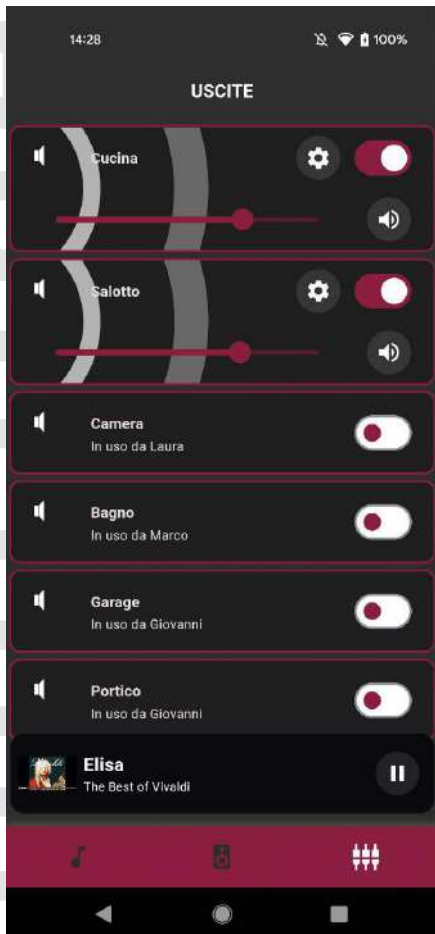
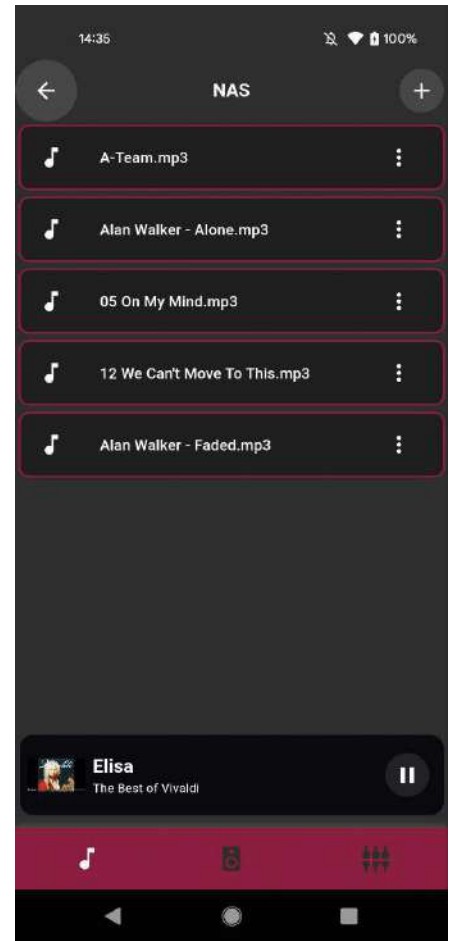
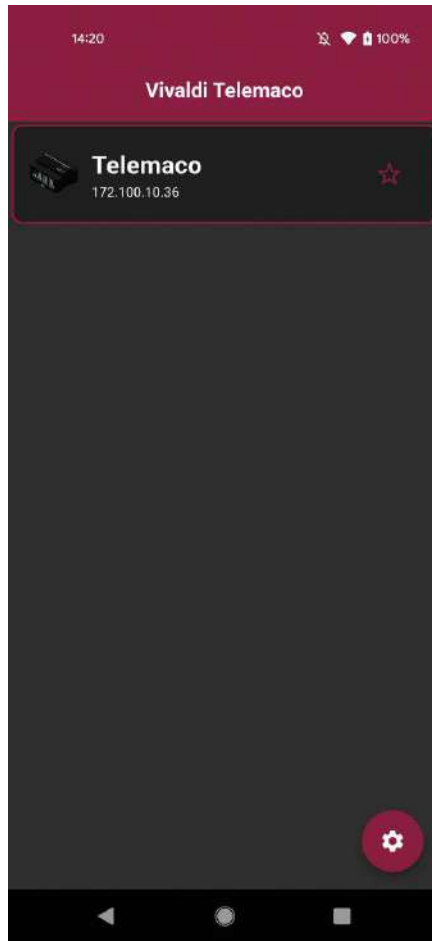
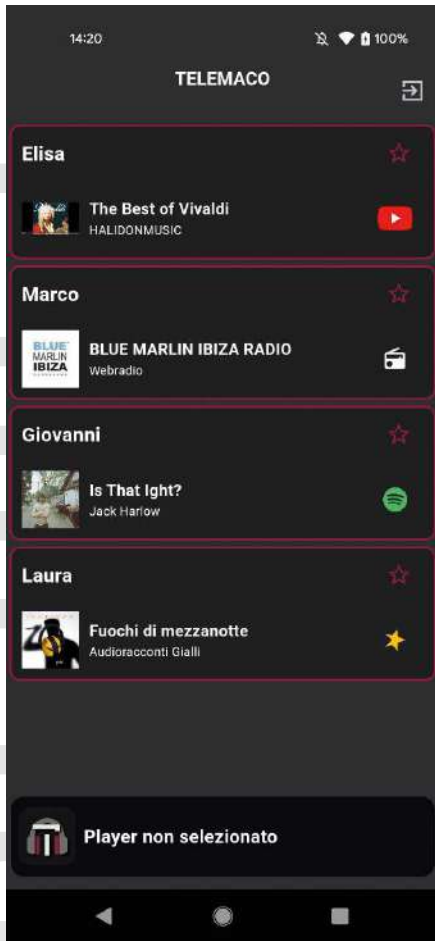

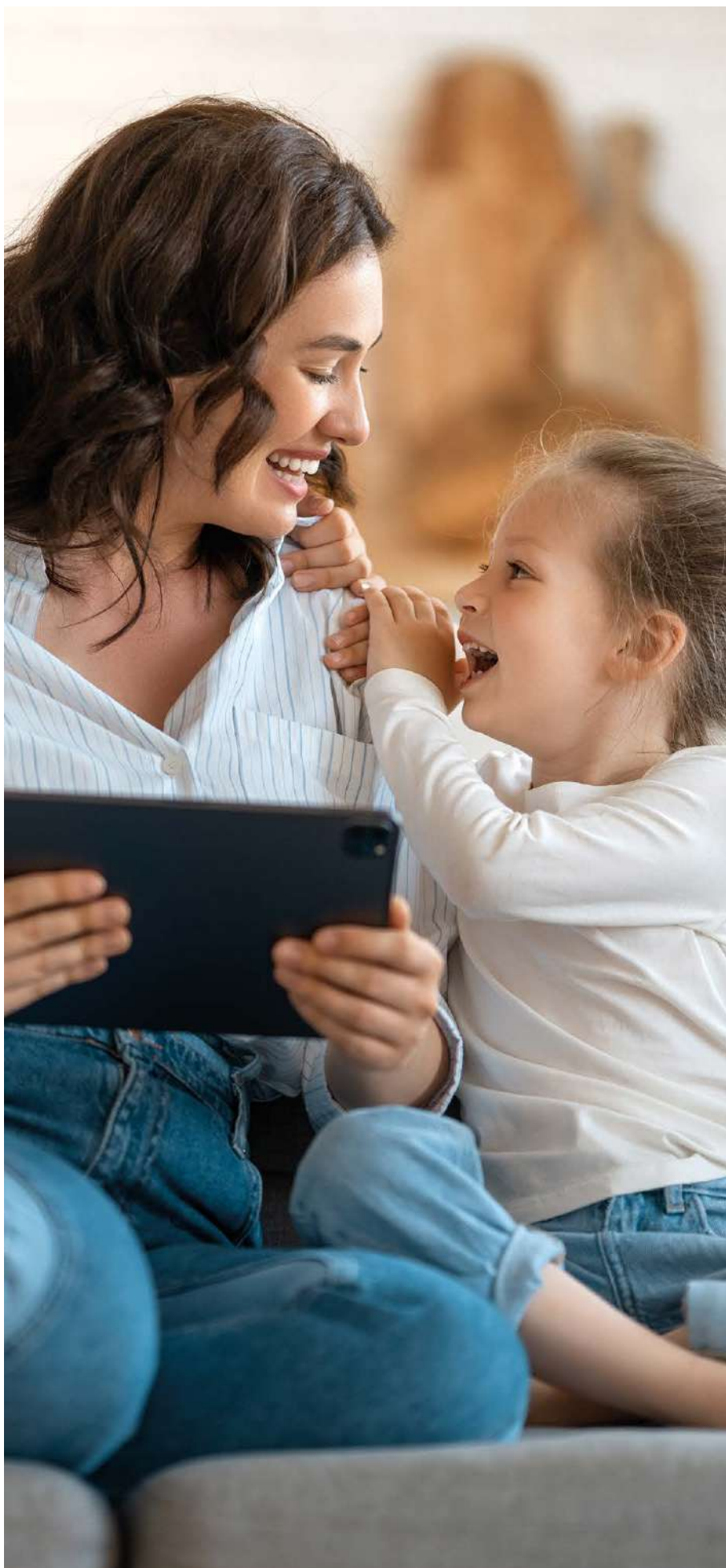
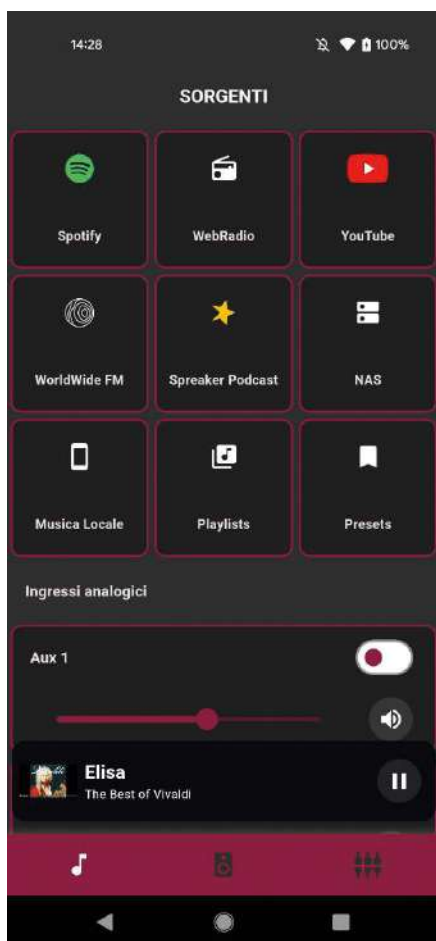
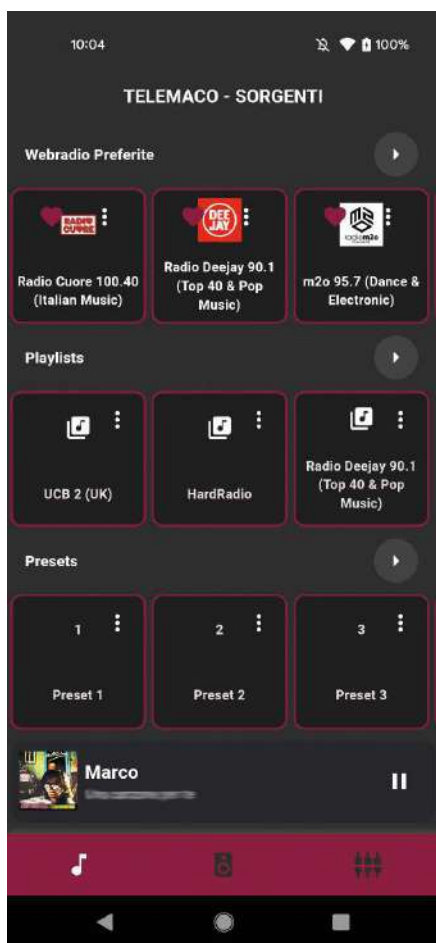







# Sorgenti multimediali con APP

Multimedia sources with APP



# App



Quando la tecnologia sposa lo stile, nasce l'emozione.

Vivaldi presenta una nuova gamma di prodotti con player multimediale Keysol integrato.

Vogliamo riempire la tua casa, il tuo giardino, il tuo ufficio, il tuo locale... di un suono brillante, potente, in ogni stanza.

Controlli WiFi.

Brani, podcast, web radio, audiolibri e molto altro, potrai riprodurre un audio diverso in ogni stanza o divertirti sincronizzando a piacere le zone dando vita ad infinite combinazioni multiroom WiFi.

Scegli tra decine di servizi.

Svegli, timer, playlist, settaggi, programmazioni...

Vivaldi ti offre un'esperienza di gestione musicale, innovativa e semplice, mantenendo uno standard di alta qualità.

When technology is linked to style, emotion is born.

Vivaldi presents a new range of products with integrated Keysol multimedia player.

We want to fill your home, your garden, your office, your room... of a brilliant, powerful sound, in every room.

Wi-Fi controls.

Songs, podcasts, web radio, audiobooks and much more, you can play a different audio in each room or have fun synchronizing the areas at will giving life to infinite Wi-Fi multi room combinations.

Choose from dozens of services.

Alarms, timers, playlists, settings, schedules...

Vivaldi offers you an innovative and simple music management experience, maintaining a high quality standard.







L'App Vivaldi ti permette di accedere e gestire facilmente la musica preferita, le radio da tutto il mondo, i podcast, gli audiolibri o le prime parole di tua figlia. Potrai visualizzare le nostre news. Il design semplice ed intuitivo accompagna una tecnologia audio di ultima generazione.

**Infinite "audiosoluzioni".**

Vivaldi app comunica e interagisce con numerosi dispositivi Vivaldi senza cablaggi invasivi permette la ricerca di infiniti contenuti e la gestione personalizzata delle zone. Puoi intervenire su ogni singolo ambiente comodamente dal tuo dispositivo mobile.

Vivaldi App allows you to easily access and manage your favorite music, radios from all over the world, podcasts, audiobooks or your daughter's first words. You can view our news. The simple and intuitive design follows a latest generation of audio technology. Endless "audio solutions".

Vivaldi app communicates and interacts with numerous Vivaldi devices without invasive wiring allows you to search for infinite contents and personalized management of zones. You can act on every single environment from the comfort of your mobile device.



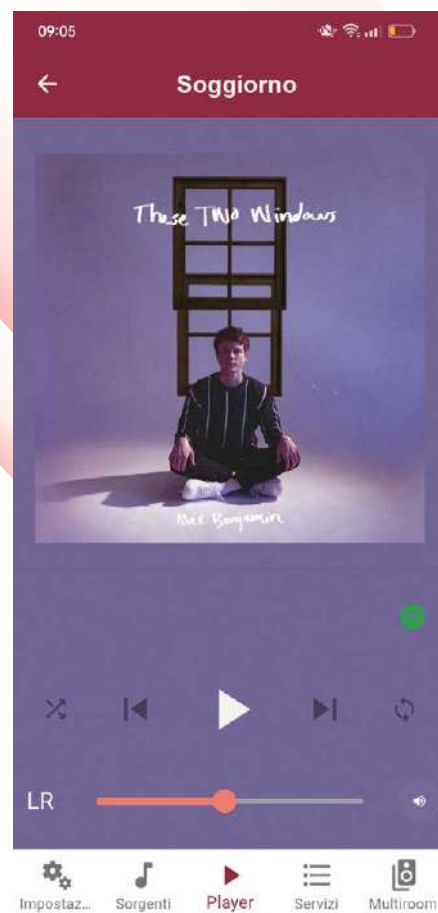
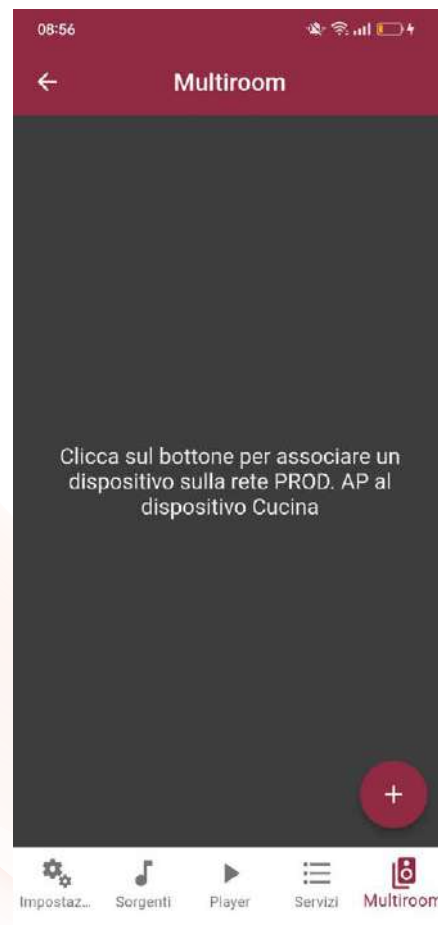
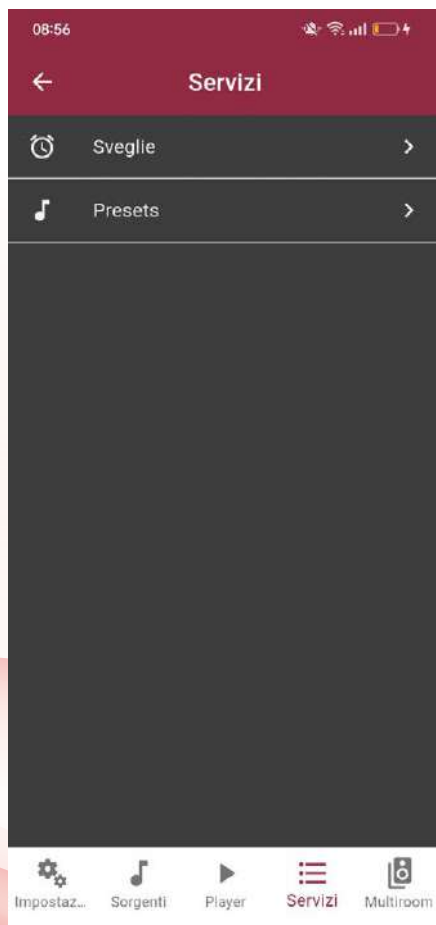
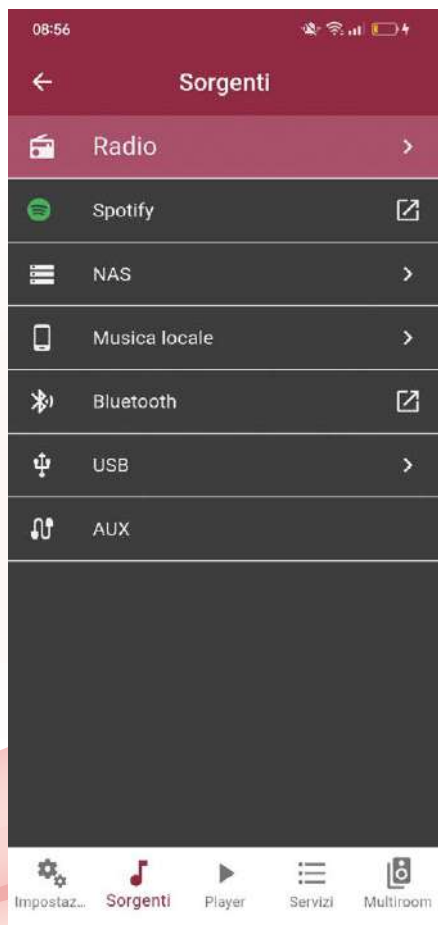

# KEYSOL



**1**  
Ingresso stereo mini-jack AUX-IN  
Mini-jack input AUXIN

**2**  
Uscita stereo di linea  
Stereo line output

**3**  
Alimentazione 5Vdc  
Power supply 5Vdc

**4**  
RJ45

**5**  
Pulsante RESET-WPS  
Button RESET-WPS

## CAMPI APPLICATIVI application fields



### KEYSOL

#### MEDIACENTER AUDIO SORGENTE MULTIMEDIALE WIFI DI ZONA CON BLUETOOTH

Riproduci musica dai tuoi dispositivi, scarica l'App gratuita!

#### MULTIROOM

Goditi la tua musica ovunque! Utilizzando più dispositivi KEYSOL puoi sincronizzare la musica o rendere indipendente ogni stanza.

#### MULTISORGENTE

Streaming audio dal tuo smartphone o tablet, web radio, archivio di rete (NAS). Effettua streaming audio dal tuo smartphone o tablet, funzione Airplay, DLNA.

#### MEDIACENTER AUDIO MULTIMEDIA SOURCE WIFI AREA WITH BLUETOOTH

Play music from your devices, download the free App!

#### MULTIROOM

Enjoy your music anywhere! Using multiple KEYSOL devices can sync music or make each room independent.

#### MULTI-SOURCE

Stream audio from your smartphone or tablet, web radio, network storage (NAS). Stream audio from your smartphone or tablet, Airplay function, DLNA.

## APPLICAZIONE GRATUITA

Con l'App KEYSOL potrai riprodurre, controllare, condividere le playlist direttamente dal tuo dispositivo (smartphone, tablet..).

## SEMPLICE DA UTILIZZARE

Installa KEYSOL.

Connettiti alla rete WiFi.

Scarica l'App gratuita da Play Store o Apple Store.

Libera il tuo mondo musicale!

## CARATTERISTICHE TECNICHE

- Ricevitore Bluetooth integrato visibile solo quando viene selezionato dall'APP, sullo smarphone viene visualizzato come "Vivaldi\_KeySol" (non ha PIN).
- APP di controllo gratuita: Giove KEYSOL (compatibile con iOS - Android).
- Supporta: Airplay, DLNA, WiFi DIRECT.
- Formati audio: AAC/LTP,HE-ACCv1,HE-ACCv2,AMR-NB,AMR, WB,FLAC, MP3,Vorbis,PCM/WAVE,ALAC.
- Rete: 1xRJ45, WiFi Standard: IEEE802.11b, IEEE802.11g, IEEE802.11n.
- Ingressi Audio: 1x Analog Audio Input.
- Uscite Audio: 1x Analog Audio Output.
- Sorgenti internet: Spotify, Tuneln, ecc.
- Sorgenti locali: musica residente nel proprio dispositivo mobile, streaming da NAS (disco di rete).
- 3 Modalità di utilizzo:
  1. One song-One Room: utilizzo di un singolo dispositivo.
  2. One song-Multiple Rooms: utilizzo di più dispositivi per musiche differenti in tutte le zone.
  3. One song-All Rooms: utilizzo di più dispositivi per la stessa musica sincronizzata in tutte le zone.
- Personalizzazione nomi dispositivi KEYSOL.
- Gestione sveglia con musica in rete.
- Ingresso Alimentazione: Micro USB 5V, 300mA.
- Certificazioni: CE, ROHS.
- Dimensioni: 115x20x95 mm (LxHxP).
- Colore nero.
- Peso: 0.18Kg.

Note: disponibile su richiesta file .apk dell'APP compatibile con versioni Android precedenti.

## FREE APPLICATION

With the KEYSOL App you can play, control and share playlists directly from your device (smartphone, tablet..).

## EASY TO USE

Install the KEYSOL.

Connect to the WiFi network.

Download the free App from the Play Store or Apple Store.

Free your musical world!

## TECHNICAL FEATURES

- Built-in Bluetooth receiver visible only when selected from the APP, visible on the device as "Vivaldi\_KeySol" (has no PIN).
- FREE CONTROL APP: GIOVE KEYSOL (compatible with iOS - Android).
- Supports: Airplay, DLNA, WiFi DIRECT.
- Audio formats: AAC/LTP,HE-ACCv1,HE-ACCv2,AMR-NB,AMR, WB,FLAC, MP3,Vorbis,PCM/WAVE,ALAC.
- Network: 1xRJ45, WiFi Standard: IEEE802.11b, IEEE802.11g, IEEE802.11n.
- Audio Inputs: 1x Analog Audio Input.
- Audio Outputs: 1x Analog Audio Output.
- Internet sources: Spotify, tunein, etc.
- Local sources: music residing on your mobile device, streaming from NAS (network disk).
- 3 How to use:
  1. One song-One Room: use of a single device.
  2. One song-Multiple Rooms: use of multiple devices for different music in all zones.
  3. One song-All Rooms: use multiple devices for the same music synchronized in all zones.
- Customizing KEYSOL device names.
- Alarm management with music on the network.
- Power Input: Micro USB 5V, 300ma.
- Certifications: CE, ROHS.
- Dimensions: 115x20x95 mm (WxHxD).
- Black colour.
- Weight: 0.18kg.

Notes: available on request .apk files of the APP compatible with previous Android versions.

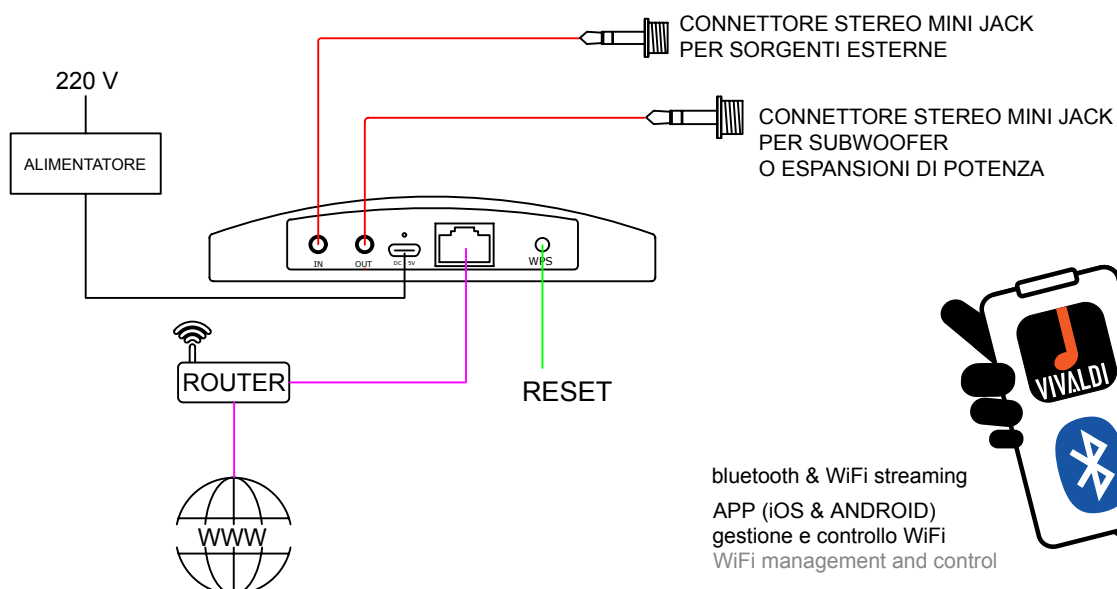

# KEYSOL-DIN

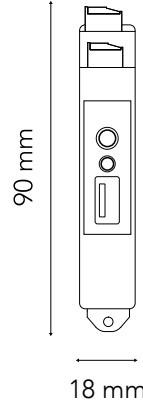
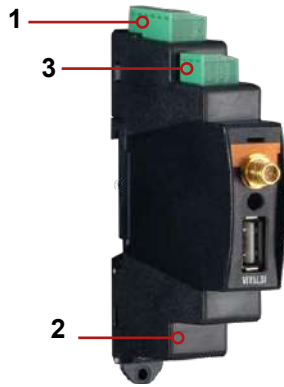

- 1**  
Alimentazione e uscita stereo bilanciata  
Power supply and Balanced stereo output
- 2**  
Connessione rete Lan  
Lan network connection
- 3**  
Ingresso stereo  
Stereo input

- 4**  
Spia LED  
LED indicator
- 5**  
Connettore SMA per antenna WI-FI  
SMA connector for WI-FI antenna
- 6**  
Pulsante reset  
Reset button
- 7**  
Porta usb  
USB port



## ALIMENTATORE power supply

AL2B in dotazione  
AL2B supplied

## CAMPI APPLICATIVI application fields



## KEYSOL-DIN

**MEDIACENTER AUDIO da BARRA DIN SORGENTE MULTIMEDIALE WIFI**  
Riproduci musica da internet (Webradio, Spotify ...), dall'USB o dai tuoi dispositivi. Scarica l'App gratuita VIVALDI su Play Store e App Store.

**MULTIROOM**  
Goditi la tua musica ovunque! Utilizzando più dispositivi KEYSOL-DIN puoi sincronizzare la musica o rendere indipendente ogni stanza. Puoi sincronizzare anche una sorgente locale.

**MULTISORGENTE**  
Streaming audio dal tuo smartphone o tablet, web radio, archivio di rete (NAS). Effettua streaming audio dal tuo smartphone o tablet, funzione Airplay, DLNA.

**MEDIACENTER AUDIO DIN BAR WIFI MULTIMEDIA SOURCE**  
Play music from the internet (Webradio, Spotify ...), from USB or from your devices. Download the VIVALDI App for free on Play Store and App Store.

**MULTIROOM**  
Enjoy your music anywhere! Using multiple KEYSOL-DIN devices you can synchronize music or make each room independent. You can also sync a local source.

**MULTISOURCE Streaming**  
audio from your smartphone or tablet, web radio, network storage (NAS). Stream audio from your smartphone or tablet, Airplay function, DLNA.



## APPLICAZIONE GRATUITA

Con l'App VIVALDI potrai riprodurre, controllare, condividere le playlist direttamente dal tuo dispositivo (smartphone, tablet..).

## SEMPLICE DA UTILIZZARE

Installa KEYSOL-DIN. Connettiti alla rete WiFi. Scarica l'App gratuita da Play Store o Apple Store.

Libera il tuo mondo musicale!

## CARATTERISTICHE TECNICHE

- APP di controllo gratuita: VIVALDI (compatibile con iOS - Android).
- Supporta: Airplay, DLNA, WiFi DIRECT.
- Formati audio: AAC/LTP, HE-ACCv1, HE-ACCv2, AMR-NB, AMR, WB, FLAC, MP3, Vorbis, PCM/WAVE, ALAC.
- Rete: 1xRJ45 per connessione alla rete LAN, WiFi Standard: IEEE802.11b, IEEE802.11g, IEEE802.11n.
- Ingressi Audio: 1x Analog Audio Input stereo sbilanciato.
- Uscite Audio: 1x Analog Audio Output stereo bilanciata.
- Sorgenti internet: Spotify, TuneIn, ecc.
- Sorgenti locali: musica residente nel proprio dispositivo mobile, streaming da NAS (disco di rete).
- USB type A su frontale per riproduzione file audio MP3/WMA/AAC/AAC+/ALAC/FLAC/APE/WAV.
- 1x Morsetto alimentazione 24Vdc (alimentatore AL2B fornito in dotazione).
- 1x SMA presa per connessione antenna 2.4Ghz WIFI.

## Modalità di utilizzo:

1. utilizzo di un singolo dispositivo con sorgente di zona.
  2. utilizzo di più dispositivi per musiche differenti su ogni zona.
  3. utilizzo di più dispositivi per la stessa musica sincronizzata in tutte le zone.
- Personalizzazione nomi dispositivi KEYSOL-DIN.
  - Gestione sveglia con musica.
  - Certificazioni: CE, ROHS.
  - Standard DIN.
  - Dimensioni (LxHxP) 18x90x63 mm (1 Modulo)
  - Peso 0.10 Kg.

## FREE APPLICATION

With the VIVALDI App you can play, control, share playlists directly from your device (smartphone, tablet ..).

## SIMPLE TO USE

Install KEYSOL-DIN. Connect to the WiFi network. Download the free App from Play Store or Apple Store.

Release your music world!

## TECHNICAL FEATURES

- Free control APP: VIVALDI (compatible with iOS - Android).
- Supports: Airplay, DLNA, WiFi DIRECT.
- Audio formats: AAC/LTP, HE-ACCv1, HE-ACCv2, AMR-NB, AMR, WB, FLAC, MP3, Vorbis, PCM/WAVE, ALAC.
- Network: 1xRJ45 for LAN connection, WiFi Standard: IEEE802.11b, IEEE802.11g, IEEE802.11n.
- Audio inputs: 1x Analog Audio Stereo Unbalanced.
- Audio outputs: 1x Analog Audio Stereo Balanced.
- Internet sources: Spotify, TuneIn, etc.
- Local sources: music residing in your mobile device, streaming from NAS (network disk).
- USB type A on the front for audio playback MP3/WMA/AAC/AAC+/ALAC/FLAC/APE/WAV.
- 1x Power supply clamp 24Vdc (power supply AL2B included).
- 1x SMA socket for 2.4Ghz antenna connection for WIFI.

## How to use:

1. using a single device with a zone source.
  2. Use multiple devices for different music on each zone.
  3. use multiple devices for the same synchronized music in all zones.
- Customization of KEYSOL-DIN device names.
  - Alarm clock management with music.
  - CE, ROHS certifications.
  - DIN standard.
  - Size (WxHxD) 18x90x63 mm (1 Module).
  - Weight 0.10 Kg.

## SOGGIORNO CON STREAMING WiFi E TV LIVING ROOM WITH WiFi STREAMING AND TV

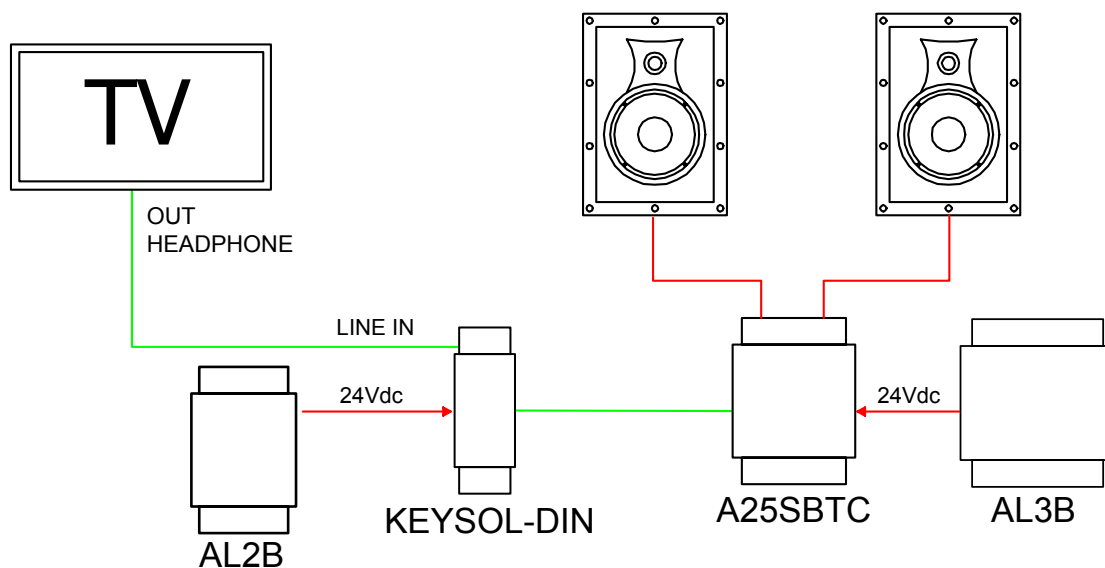

### CABLE LEGEND

- CAVO DI ALIMENTAZIONE POLARIZZATO 2x1mm  
POLARIZED CABLE FOR POWER SUPPLY 2x1mm
- CAVO MICRO2  
MICRO2 CABLE



APP (iOS & ANDROID)  
gestione e controllo WiFi  
WiFi management and control



# Amplificatori multimediali con sorgenti

Multimedia amplifiers with sources



# KEYSOL-15S

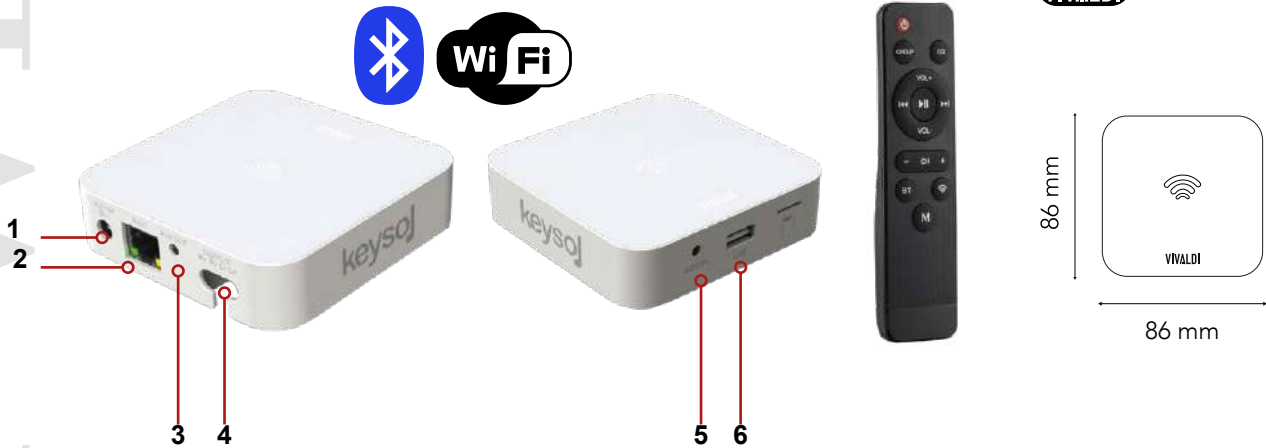

**1**  
Jack alimentazione  
Jack power supply

**2**  
Porta RJ45 collegamento LAN  
RJ45 port LAN connection

**3**  
Jack per uscita audio di linea  
stereo  
Jack stereo line output

**4**  
Uscita audio stereo amplificata  
Amplified stereo audio output

**5**  
Ingresso stereo minijack  
Minijack stereo input

**6**  
Porta USB  
USB port

## DIFFUSORI CONSIGLIATI

recommended speakers

KEOPE.S40, MINI8, GIADA16F

## CAMPI APPLICATIVI

application fields



## KEYSOL-15S

### MEDIACENTER AUDIO ATTIVO SORGENTE MULTIMEDIALE WiFi E BLUETOOTH HiFi Stereo 15W+15W RMS (30+30W musicali)

Riproduci musica da internet (Webradio, Spotify ...), dall'USB o dai tuoi dispositivi tramite il Bluetooth o la funzione AirPlay. Scarica l'App gratuita Vivaldi da Play Store e App Store. MULTISORGENTE

Streaming audio dal tuo smartphone o tablet, web radio, archivio di rete (NAS). Effettua streaming audio dal tuo smartphone o tablet, funzione Airplay, DLNA, Bluetooth.

#### APPLICAZIONE GRATUITA

Con l'App VIVALDI potrai riprodurre, controllare, condividere le playlist direttamente dal tuo dispositivo (smartphone, tablet...).

#### SEMPLICE DA UTILIZZARE

Installa KEYSOL-15S. Connettiti alla rete WiFi. Scarica l'App gratuita da Play Store o Apple Store.

### MEDIACENTER ACTIVE AUDIO MULTIMEDIA WiFi SOURCE AND BLUETOOTH HiFi Stereo 15W+15W RMS (30+30W musical)

Play music from the internet (Webradio, Spotify ...), Bluetooth, Airplay, USB or from your devices.

Download the free VIVALDI App on the Play Store and App Store.

#### MULTISOURCE Streaming

audio from your smartphone or tablet, web radio, network storage (NAS). Stream audio from your smartphone or tablet, Airplay function, DLNA, Bluetooth.

#### FREE APPLICATION

With the VIVALDI App you can play, control, share playlists directly from your device (smartphone, tablet ..).

#### SIMPLE TO USE

Install KEYSOL-15S. Connect to the WiFi network. Download

Libera il tuo mondo musicale!

Attivo 15+15W. APP di controllo gratuita: Vivaldi (compatibile con iOS - Android). Supporta: Airplay, DLNA, WiFi DIRECT, Bluetooth. Nome bluetooth "VIVALDI-KEYSOL". Formati audio: AAC/LTP, HE-ACCv1, HE-ACCv2, AMR-NB, AMR, WB, FLAC, MP3, Vorbis, PCM/WAVE, ALAC. Rete: 1xRJ45 per connessione alla rete LAN, WiFi Standard: IEEE802.11b, IEEE802.11g, IEEE802.11n. Ingressi Audio: 1x Analog Audio Input (Mini Jack Stereo 3,5mm). Uscite Audio: 1x Analog Audio Output stereo (Mini Jack Stereo 3,5mm). Sorgenti internet: Spotify, TuneIn, ecc. Uscite audio amplificate 15W+15W per collegamento diffusori 4 -8Ω. Sorgenti locali: musica residente nel proprio dispositivo mobile, streaming da NAS (disco di rete). USB type A su frontale per riproduzione file audio MP3/WMA/AAC/AAC+/ALAC/FLAC/APE/WAV. 1x connettore alimentazione 15Vdc 2A (alimentatore fornito in dotazione). Funzione sveglia con musica. Certificazioni: CE, ROHS. Dimensioni 86x20x86 mm (LxHxP). Peso 0,10 Kg. Telecomando fornito in dotazione.

the free App from Play Store or Apple Store. Release your music world!

Active 15+15W.  
Free control APP: VIVALDI (compatible with iOS - Android).  
Supports: Airplay, DLNA, WiFi DIRECT, BLUETOOTH.  
Bluetooth name "VIVALDI-KEYSOL".  
Audio formats: AAC/LTP, HE-ACCv1, HE-ACCv2, AMR-NB, AMR, WB, FLAC, MP3, Vorbis, PCM/WAVE, ALAC.  
Network: 1xRJ45 for LAN connection, WiFi Standard: IEEE802.11b, IEEE802.11g, IEEE802.11n.  
Audio Inputs: 1x Analog Audio Input (Mini Jack Stereo 3.5mm).  
Audio Outputs: 1x Analog Audio Stereo Output (Mini Jack Stereo 3.5mm). Internet sources: Spotify, TuneIn, etc.  
Amplified audio outputs 15W+15W for connecting 4 or 8Ω speakers.  
Local sources: music in your mobile device, streaming from NAS (network disk). USB type A on the front for audio file playback MP3/WMA/AAC/AAC+/ALAC/FLAC/APE/WAV.  
1x 15Vdc 2A power connector (power supply included).  
Size 86x20x86 mm (WxHxD). Weight 0.10 kg.  
Alarm clock function with music. Certifications: CE, ROHS.  
Remote control included.

## KEYSOL-15S ACTIVE 15+15W MULTIMEDIA PLAYER

2.1 WiFi E BLUETOOTH AUDIO STREAMING CON INGRESSO PER SORGENTE LOCALE  
2.1 WiFi AND BLUETOOTH AUDIO STREAMING WITH LOCAL SOURCE INPUT

KEOPE.S40, MINI8 or GIADA16F

SPEAKERS 8Ω  
(MAX 2)

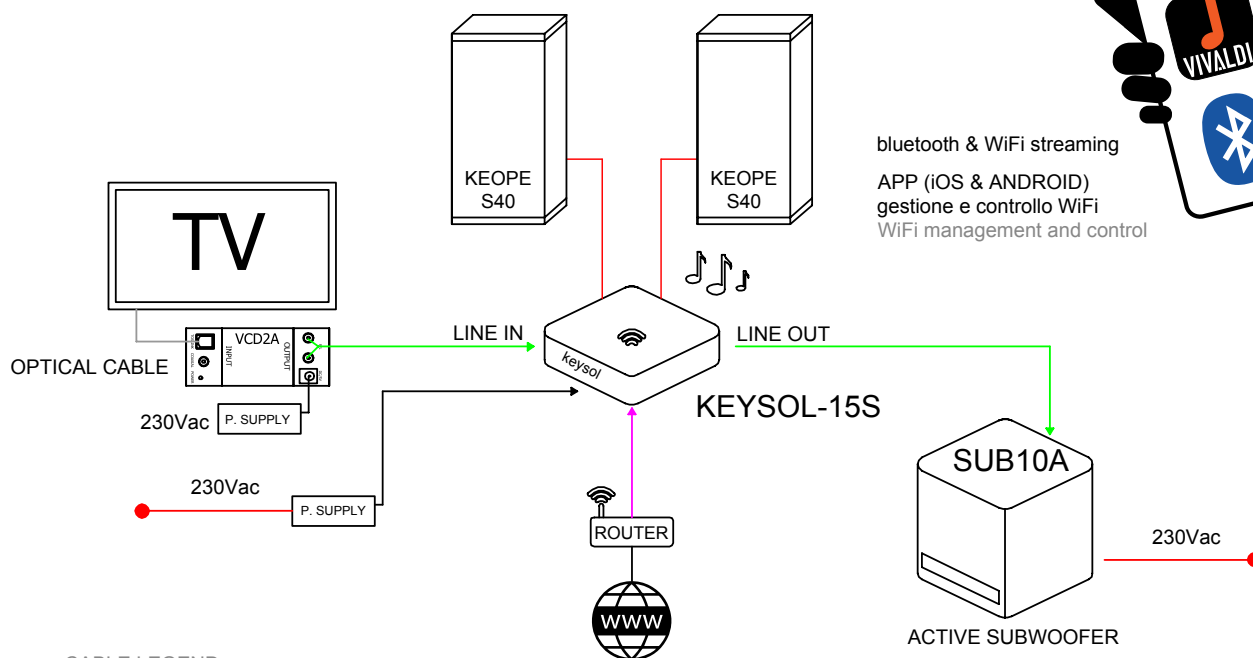

### CABLE LEGEND

- CAVO DI ALIMENTAZIONE POLARIZZATO 2x1mm  
POLARIZED CABLE FOR POWER SUPPLY 2x1mm
- CAVO MICRO2  
MICRO2 CABLE
- CAVO OTTICO  
OPTICAL CABLE
- CAVO CAT6  
CAT6 CABLE

# P40SL

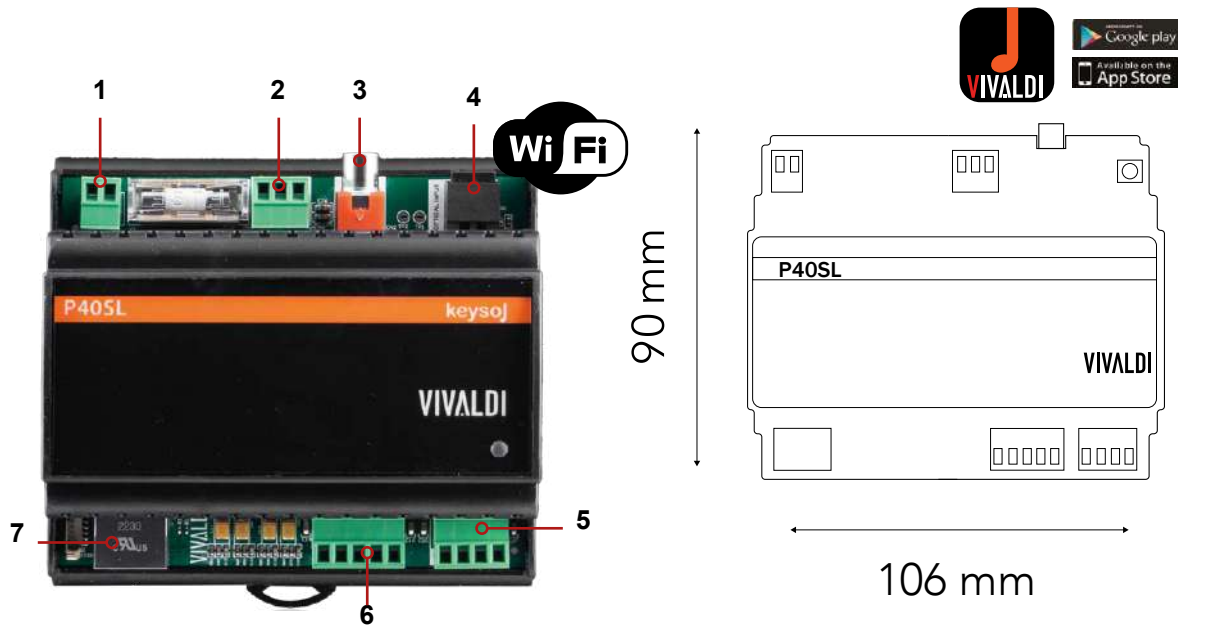

- |                                                                                                                                                                                            |                                                                                                                                                                                                                     |                                                                                            |
|--------------------------------------------------------------------------------------------------------------------------------------------------------------------------------------------|---------------------------------------------------------------------------------------------------------------------------------------------------------------------------------------------------------------------|--------------------------------------------------------------------------------------------|
| <p><b>1</b><br/>Alimentazione 24VDC<br/>Power supply 24 VDC</p> <p><b>2</b><br/>Ingresso aux<br/>Input aux</p> <p><b>3</b><br/>Ingresso SPDIF e coassiale<br/>SPDIF and coaxial inputs</p> | <p><b>4</b><br/>Pulsante reset<br/>Reset button</p> <p><b>5</b><br/>Uscita amplificata stereo<br/>Stereo amplified output</p> <p><b>6</b><br/>Uscita Preout Stereo bilanciata<br/>Balanced pre-out audio output</p> | <p><b>7</b><br/>Porta RJ45 per connessione a rete LAN<br/>RJ45 port for LAN connection</p> |
|--------------------------------------------------------------------------------------------------------------------------------------------------------------------------------------------|---------------------------------------------------------------------------------------------------------------------------------------------------------------------------------------------------------------------|--------------------------------------------------------------------------------------------|

## ALIMENTATORE power supply

AL5B (24 Vdc 4,16A, 100W)  
AL6B (24 Vdc 6,25A, 150W)  
AL7B (24 Vdc 10A, 240W)

## CAMPI APPLICATIVI application fields



## P40SL

**Amplificatore stereo multimediale con player WiFi Keysol integrato.**

**Potenza classe-D 40+40W @ 8Ω, 70+70W @ 4Ω.**

APP di supervisione e controllo Vivaldi (scaricabile da iOS & Android).

1 INGRESSO LINE.

1 INGRESSO DIGITALE TOSLINK e RCA.

1 USCITA STEREO BILANCIATA per espansioni di potenza (A25SBTC, E30S, E80S, finali di potenza

**Multimedia class-D stereo power amplifier with integrated Keysol WiFi player.**

**40+40W @ 8Ω, 70+70W @ 4Ω.**

Vivaldi supervision and control APP (downloadable from iOS & Android).

1 LINE INPUT.

1 TOSLINK AND RCA INPUT.

1 BALANCED STEREO OUTPUT for power expansions (A25SBTC, E30S, E80S, 8Ω/100V

Linea Vivaldi Ulisse a 8Ω/100V) o subwoofer attivi.  
1 RJ45 per rete LAN.  
Controllo parametri audio con gestione volumi/settaggi  
from App.  
Alimentazione 24Vdc tramite AL5B (non incluso).  
Standard DIN (6 moduli).  
Dimensioni (LxHxP): 108x90x63 mm.  
Peso 0.25 Kg.

Vivaldi Ulisse Line power amps) or active subwoofers.  
1 RJ45 per LAN.  
Audio parameter control with volume/settings  
from App.  
Power supply 24Vdc via AL5B (not included).  
DIN standard (6 modules).  
Size (WxHxD): 108x90x63 mm.  
Weight 0.25 Kg.



### AL5B

Alimentatore da barra DIN (7,5 moduli). Input 100-240  
Vac 50Hz 1,2A. Output 24 Vdc 4,16A, 100W. Colore nero.  
Dimensioni 138x88x65 mm (LxHxP). Peso 0,33 Kg.

DIN rail power supply (7,5 modules)  
Input 100-240 Vac 50Hz 1,2A  
Output 24 Vdc, 4,16A, 100W. Size: 138x88x65 mm  
(WxHxD). Weight 0,33 Kg.



### AL6B

Alimentatore da barra DIN (6 moduli). Input 100-240 Vac  
50Hz 1,8A. Output 24 Vdc 6,25A, 150W. Colore nero.  
Dimensioni 103x58x90 mm (LxHxP). Peso 0,35 Kg.

DIN rail power supply (6 modules). Input 100-240 Vac  
50Hz 1,8A. Output 24 Vdc 6,25A, 150W. Black colour. Size  
103x58x90 mm (WxHxD). Weight 0,35 Kg.



### AL7B NEW

Alimentatore da barra DIN. Input 100-240 Vac  
50/60Hz 2,6A. Output 24 Vdc 10A, 240W. Dimensioni  
65x126x110 mm (LxHxP). Peso 1,1 Kg. Colore nero.

DIN rail power supply. Input 100-240 Vac 50/60Hz  
2,6A. Output 24 Vdc 10A, 240W. Size 65x126x110  
mm (WxHxD). Weight 1,1 Kg. Black

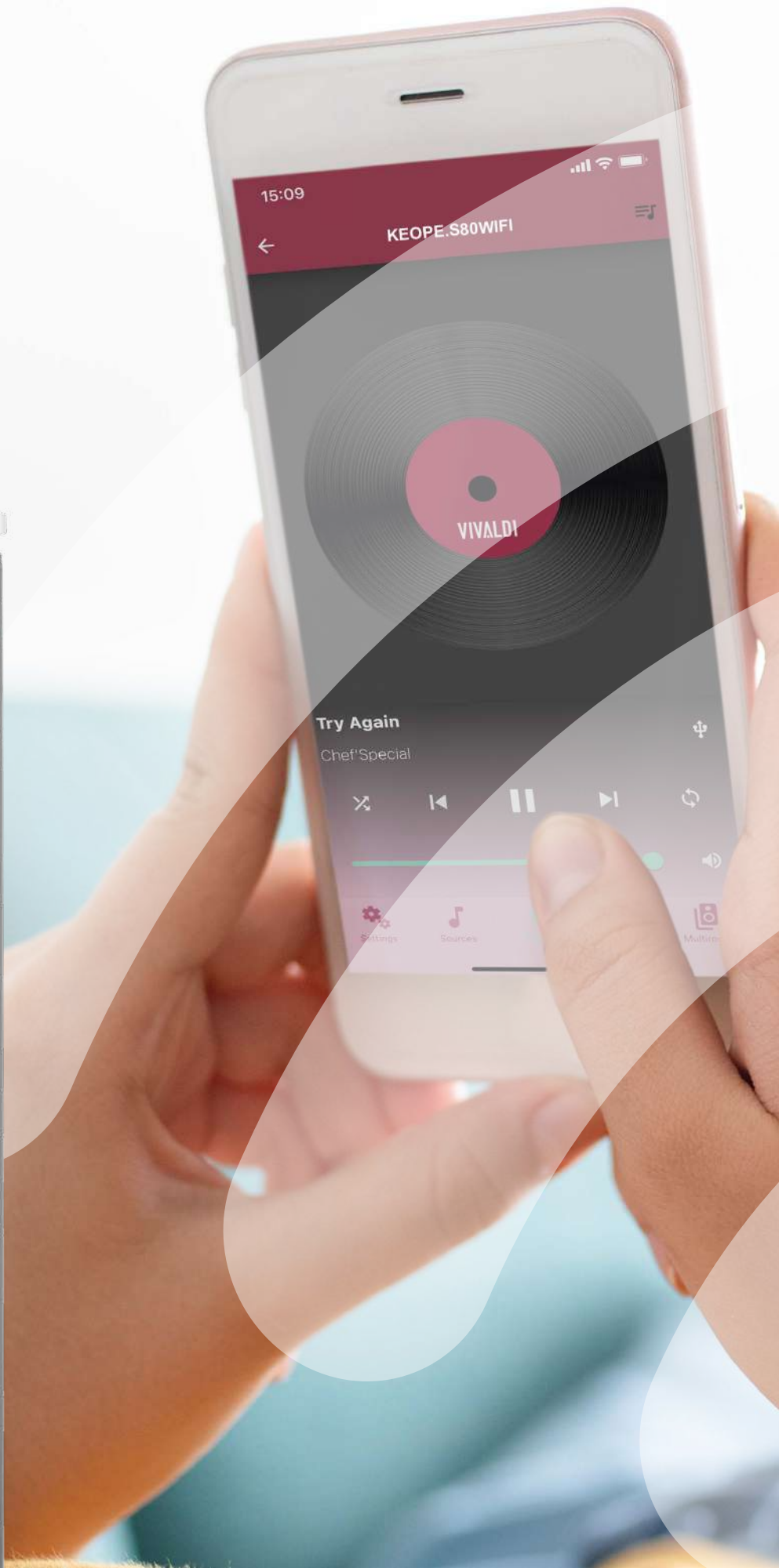



# Diffusori multimediali attivi con sorgenti

Active multimedia speakers with sources

# KEYROUND16AF

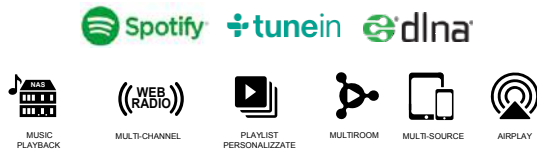

**CAMPI APPLICATIVI**  
application fields

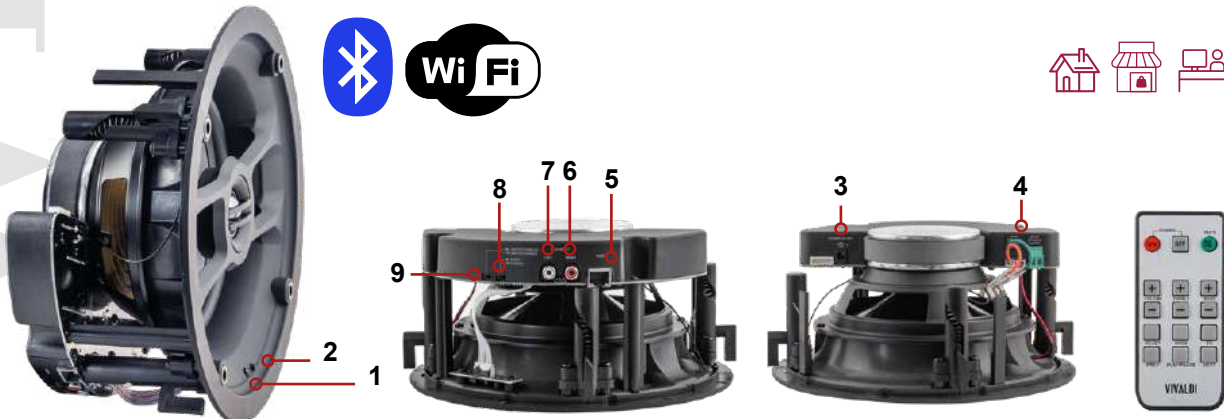

**1**  
Spia LED accensione  
LED indicator ignition

**2**  
Pulsante WPS  
WPS button

**3**  
Ingresso DC  
Input DC power

**4**  
Morsetto collegamento  
speakers passivo  
Passive speaker connection  
terminal

**5**  
RJ45  
RJ45

**6**  
RCA L rosso  
RCA L red

**7**  
RCA L bianco  
RCA L white

**8**  
Stereo/mono  
Stereo/mono

**9**  
Limitazione volume  
Volume limiter

## KEYROUND16AF



**KEYROUND16AF.F.R** (min 10pz, colore personalizzabile/ min 10 pcs custom color)

KIT multimediale con tecnologia WiFi e Bluetooth composto da:  
n. 1 diffusore KEYROUND16AF con integrazione multimediale Keysol.  
n. 1 diffusore ROUND16F.  
n.1 telecomando

### DETTAGLIO PRODOTTI

#### n. 01 - KEYROUND16AF MASTER

**diffusore MASTER rotondo**, serie design Frameless, semi-filomuro, da incasso a soffitto.

**ATTIVO, 2 vie, 2x30W RMS, HI-FI, con player multimediale WiFi Keysol Bluetooth integrato.**

**Porta LAN per connessione di rete (RJ45).**

1 ingresso stereo RCA ausiliario per sorgente esterna.

1 uscita di potenza per diffusore SLAVE (30W RMS).

Alimentatore di sistema 24V, 2,5A fornito in dotazione.

Woofer 16,5 cm

Tweeter da 1,9 cm a cupola orientabile, in titanio,

magnete al neodimio

**Potenza 2x30W RMS**

### Multimedia WiFi and Bluetooth speakers kit:

**nr. 1 KEYROUND16AF speaker with built in Keysol integrated.**

**nr. 1 ROUND16F**

**n1. remote control**

### SPECIFICATIONS

#### n. 01 - KEYROUND16AF MASTER

**round MASTER speaker**, Frameless design series, semi-flush wall, recessed ceiling.

**ACTIVE, 2 way, 2x30W RMS, HI-FI, with multimedia player WiFi Keysol and Bluetooth integrated.**

**Network LAN port connection (RJ45).**

1 auxiliary stereo PIN input for external source.

1 power output for SLAVE speaker (30W RMS).

System power supply 24V, 2.5A included.

Woofer 16.5 cm, titanium adjustable dome tweeter with neodymium magnet 1.9 cm.

**RMS Power 2x30W**

**Musical Power 2x60W**

Frequency response 60-20000 Hz

### Potenza musicale 2x60W

Risposta in frequenza 60-20000 Hz  
 Sensibilità 90 dB  
 Angolo di dispersione 120° (V/O)  
 Cabinet ABS V0 con griglia di protezione zincata verniciata.  
 Temperatura di lavoro da -20° a +65°.  
 Dimensioni (DxP) 227x100 mm  
 Foro da incasso (D) 210 mm  
 Peso 1,8 Kg

### n. 01 - ROUND16F SLAVE

diffusore SLAVE rotondo, 2 vie da incasso, HI-FI, Frameless  
 Impedenza 8Ω

Incasso su cartongesso, pareti di legno e simili: non servono accessori, il diffusore, nel retro, è provvisto di ganci per l'ancoraggio stabile.  
 Incasso su muratura: non adatto.

Colore bianco RAL 9016, verniciabile (KEYROUND16AF.R).  
 Cabinet ABS V0 con griglia di protezione zincata verniciata.  
 Temperatura di lavoro da -20° a +65°.  
 Telecomando fornito in dotazione.

Sensitivity 90 dB  
 Dispersion angle 120° (V / H)  
 Cabinet ABS V0 with painted galvanized protection grille.  
 Working temperature from -20° to +65°.  
 Size (DxD) 227x100 mm  
 Built-in hole (D) 210 mm  
 Weight 1,8 Kg

### n. 01 - ROUND16F SLAVE

Round speaker, 2 way in-ceiling, HI-FI, Frameless  
**Impedance: 8Ω**

**Recessed on drywall**, wood walls and similar: no accessories need, the speaker is provided with some hooks for stable anchoring in the rear side.  
**Installation in-wall:** not suitable

White colour RAL 9016, paintable  
 ABS V0 cabinet with painted galvanized grille.  
 Working temperature from -20° to +65°  
 Remote control included.

## KEYROUND16AF KIT MULTIMEDIA WIFI SPEAKERS

DIFFUSORI DA INCASSO CON PLAYER WiFi INTEGRATO  
 IN-CEILING SPEAKERS WITH WiFi PLAYER INTEGRATED

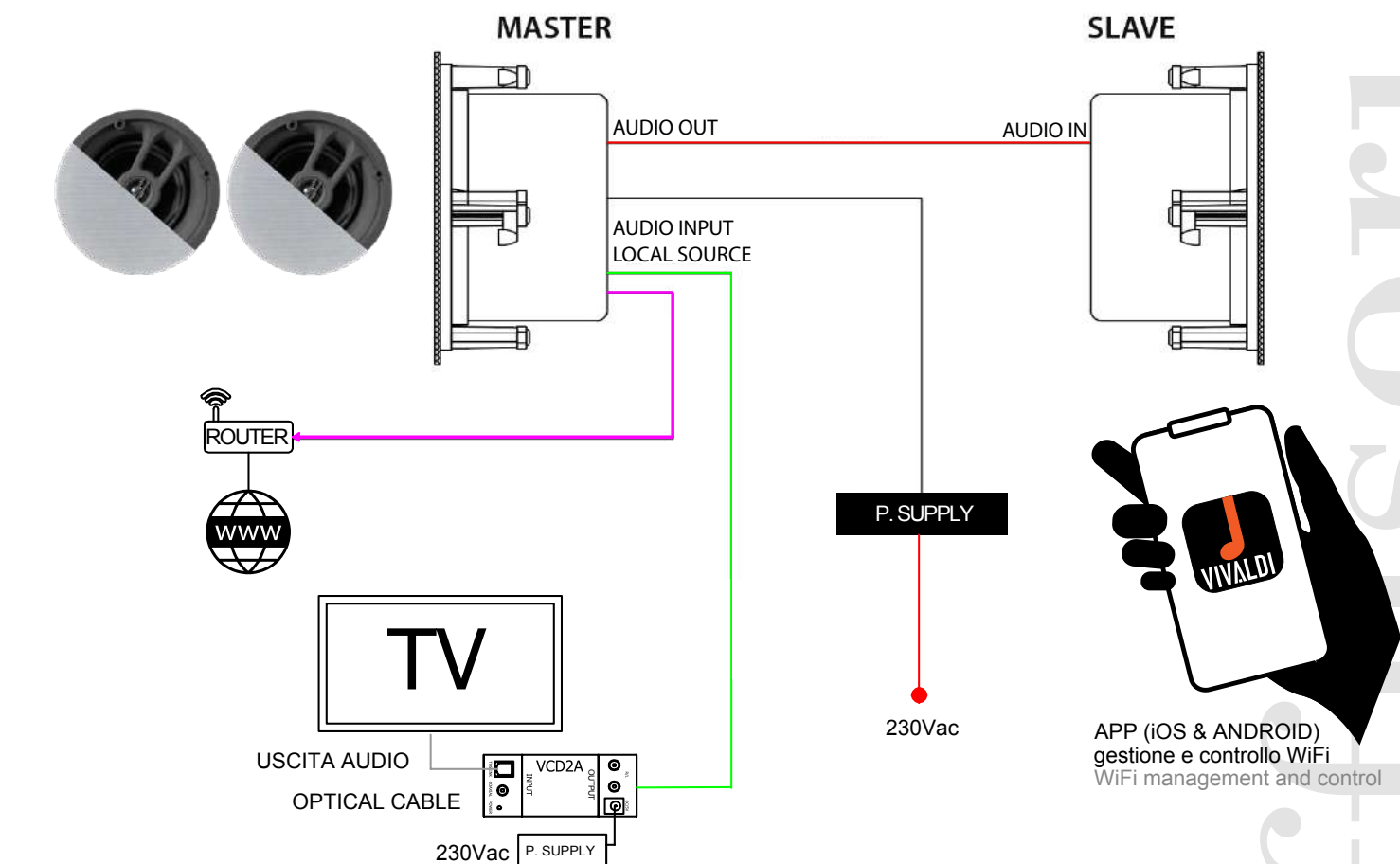

#### CABLE LEGEND

- CAVO DI ALIMENTAZIONE POLARIZZATO 2x1mm  
POLARIZED CABLE FOR POWER SUPPLY 2x1mm
- CAVO MICRO2 MICRO2 CABLE
- CAVO OTTICO OPTICAL CABLE
- CAVO CAT6 CAT6 CABLE

## KEOPE



KEOPE.S40WiFi



### Diffusori WiFi con player integrato WiFi speakers with player

#### KEOPE.S40WiFi

calze colorate (vedi pag. 142 - 143 da ordinare a parte)  
colored covers (see page 142 - 143 not included)

**Diffusore stereo ATTIVO multimediale con player Bluetooth e WiFi Keysol integrato.**

**APP di supervisione e controllo Vivaldi (scaricabile da iOS & Android).**

**Potenza amplificatore, con DSP, classe-D 40+40W RMS @ 8Ω.**

Woofer 9 cm.  
Tweeter 2,5 cm dome.  
Risposta in frequenza 70-20000Hz +-5dB.  
Max Output Level 101 dB. 104dB peak.

1 ingresso LINE.  
1 ingresso Digitale (coax e optical toslink)  
1 USB type A sul retro per riproduzione file audio MP3/WMA/AAC/AAC+/ALAC/FLAC/APE/WAV.

1 uscita di potenza per secondo diffusore passivo (slave speaker).

**1 uscita di segnale mono (subwoofer attivi).**

1 RJ45 per rete LAN.  
Alimentatore input 100-240Vac, output 26Vdc (fornito in dotazione).  
Dimensioni 110x235x130 mm (LxHxD).

Peso 3Kg. Cabinet in legno.  
Finiture alluminio spazzolato.  
Calza colore di serie: nero.  
Telecomando fornito in dotazione.

**ACTIVE multimedia stereo speaker kit with integrated Bluetooth and Keysol WiFi player.**

Vivaldi supervision and control APP (downloadable from iOS & Android).

**DSP, class-D power amplifier, 40+40W RMS @ 8Ω.**

Woofer 9 cm.  
Dome tweeter 2.5cm.  
Frequency response 70-20000Hz +-5dB.  
Maximum output level 101 dB. 104 dB peak.

1 LINE input.  
1 TOSLINK optical and coax input.

1 USB Type-A on the rear for MP3/WMA/AAC/AAC+/ALAC/FLAC/APE/WAV audio file playback.

1 power output for second passive (slave) speaker.

**1 mono signal output (active subwoofer).**

1 RJ45 per LAN.  
Power supply input 100-240Vac, output 26Vdc (included). Size 110x235x130 mm (WxHxD).  
Weight 3Kg.  
Wooden cabinet.  
Brushed aluminium finishes.

Standard colored cover black.  
Remote control included.



KEOPE.S80WiFi



#### KEOPE.S80WiFi

calze colorate (vedi pag. 142 - 143 da ordinare a parte)  
colored covers (see page 142 - 143 not included)

**Come KEOPE.S40WiFi ma potenza amplificatore, con DSP, classe-D 70+70W RMS @ 4Ω.**

Woofer 2x9 cm.  
Tweeter 2,5 cm dome.  
Risp. in freq. 65-20000Hz +-5dB.  
Max Output Level 105dB.  
108dB peak.

Dim. 110x450x130 mm (LxHxD).  
Peso 4,5Kg.

**Like KEOPE.S40WiFi but DSP, class-D power amplifier 70+70W RMS @ 4Ω.**

Woofer 2x9 cm.  
Dome tweeter 2.5cm.  
Frequency response 65-20000Hz +-5dB.

Max Output Level 105dB.  
108dB peak.

Size 110x450x130 mm (WxHxD).  
Weight 4,5Kg.



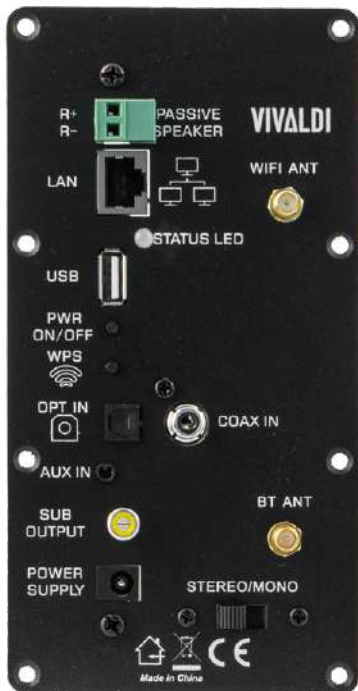

**KEOPE.SOUNDB80WIFI**

calze colorate (vedi pag. 142 - 143 da ordinare a parte)  
colored covers (see page 142 - 143 not included)

**Soundbar stereo ATTIVA multimediale con player Bluetooth e WiFi Keysol integrato.**

**APP di supervisione e controllo Vivaldi (scaricabile da iOS & Android).**

**Potenza amplificatore, con DSP, classe-D 40+40W RMS @ 8Ω.**

Woofers 2x9 cm.  
Tweeter 2x2,5 cm dome.  
Risposta in frequenza 70-20000Hz +-5dB.  
Max Output Level 106 dB. 109dB peak.

1 ingresso LINE.  
1 ingresso Digitale (coax e optical toslink)  
1 USB type A sul retro per riproduzione file audio MP3/WMA/AAC/AAC+/ALAC/FLAC/APE/WAV.

**1 uscita di segnale mono (subwoofer attivi).**

1 RJ45 per rete LAN.  
Alimentatore input 100-240Vac, output 26Vdc (fornito in dotazione).  
Dimensioni 615x110x130 mm (LxHxP).  
Peso 3,5Kg.  
Cabinet in legno.  
Finiture alluminio spazzolato.  
Calza colore di serie: nero.  
Telecomando fornito in dotazione.

**ACTIVE multimedia stereo soundbar kit with integrated Bluetooth and Keysol WiFi player.**

Vivaldi supervision and control APP (downloadable from iOS & Android).

**DSP, class-D power amplifier, 40+40W RMS @ 8Ω.**

Woofers 2x9 cm.  
Dome tweeter 2x2.5 cm.  
Frequency response 70-20000Hz +-5dB.  
Maximum output level 106 dB.  
Peak of 109 dB.

1 LINE input.  
1 Digital input (coaxial and toslink)  
1 USB Type-A on the rear for MP3/WMA/AAC/AAC+/ALAC/FLAC/APE/WAV audio file playback.  
**1 mono signal output (active subwoofer).**

1 RJ45 per LAN.  
Power supply input 100-240Vac, output 26Vdc (included).  
Size 615x110x130 mm (WxHxD).  
Weight 3,5Kg.  
Wooden cabinet.  
Brushed aluminium finishes.  
Standard colored cover black.  
Remote control included.



KEOPE.SOUNDB80WIFI

**KEOPE.SOUNDB160WIFI**

calze colorate (vedi pag. 142 - 143 da ordinare a parte)  
colored covers (see page 142 - 143 not included)

**Come KEOPE.SOUNDB80WiFi ma potenza amplificatore, con DSP, classe-D 70+70W RMS @ 4Ω.**

Woofers 4x9 cm. Tweeter 2x2,5 cm dome. Resp. in freq. 70-20000Hz +-5dB. Max Output Level 111dB.

114dB peak.  
Dim. 915x110x130 mm (LxHxP).  
Peso 7 kg.

**Like KEOPE.SOUNDB80WiFi with DSP, class-D power amplifier, 70+70W RMS @ 4Ω.**

Woofers 4x9 cm. Dome tweeter 2x2.5 cm.  
Frequency response. 70-20000Hz +-5dB. Maximum output level 111dB. 114 dB peak.  
Size 915x110x130 mm (WxHxD).  
Weight 7 kg.



KEOPE.SOUNDB160WIFI



KEOPE.HP60WiFi



KEOPE.M250WiFi

## KEOPE.HP60WIFI

calze colorate (vedi pag. 142 - 143 da ordinare a parte)  
colored covers (see page 142 - 143 not included)

**Diffusore stereo ATTIVO multimediale con player Bluetooth e WiFi Keysol integrato.**

**APP di supervisione e controllo Vivaldi (scaricabile da iOS & Android). Potenza amplificatore, con DSP, classe-D 40+40W RMS @ 8Ω.**

Woofer 15 cm.  
Tweeter 2,5 cm dome.  
Risposta in frequenza 65-20000Hz +-5dB.  
Max Output Level 106 dB. 109dB peak.

1 ingresso LINE.  
1 ingresso Digitale (coax e optical toslink)  
1 USB type A sul retro per riproduzione file audio MP3/WMA/AAC/AAC+/ALAC/FLAC/APE/WAV.  
1 uscita di potenza per secondo diffusore passivo (slave speaker).

**1 uscita di segnale mono (subwoofer attivi).**

1 RJ45 per rete LAN.  
Alimentatore input 100-240Vac, output 26Vdc (fornito in dotazione).  
Dimensioni 172x275x210 mm (LxHxP)  
Peso 6,5Kg  
Cabinet in legno.  
Finiture alluminio spazzolato.  
Calza colore di serie: nero.  
Telecomando fornito in dotazione.

**ACTIVE multimedia stereo speaker with integrated Bluetooth and Keysol WiFi player.**

Vivaldi supervision and control APP (downloadable from iOS & Android).

**DSP, class-D power amplifier, 40+40W RMS @ 8Ω.**

Woofer 15 cm.  
Dome tweeter 2.5cm.  
Frequency response 65-20000Hz +-5dB.  
Max Output Level 106 dB. 109dB peak.

1 LINE input.  
1 Digital input (coax and optical toslink)  
1 USB type A on the rear for MP3/WMA/AAC/AAC+/ALAC/FLAC/APE/WAV audio file playback.  
1 power output for second passive (slave) speaker.

**1 mono signal output (active subwoofer).**

1 RJ45 per LAN.  
Power supply input 100-240Vac, output 26Vdc (included).  
Size 172x275x210 mm (WxHxD)  
Weight 6,5Kg. Wooden cabinet.  
Brushed aluminium finishes.  
Standard colored cover black.  
Remote control included.

## KEOPE.M250WIFI

calze colorate (vedi pag. 142 - 143 da ordinare a parte)  
colored covers (see page 142 - 143 not included)

**Diffusore stereo ATTIVO multimediale con player Bluetooth e WiFi Keysol integrato.**

**APP di supervisione e controllo Vivaldi (scaricabile da iOS & Android). Potenza amplificatore, con DSP, classe-D 70+70W RMS @ 4Ω.**

Woofer 2x15 cm. Tweeter 2,5 cm dome. Risposta in frequenza 45-20000Hz +-5dB. Max Output Level 112dB. 115 peak.

1 ingresso LINE.  
1 ingresso Digitale (coax e optical toslink)  
1 USB type A sul retro per riproduzione file audio MP3/WMA/AAC/AAC+/ALAC/FLAC/APE/WAV.  
1 uscita di potenza per secondo diffusore passivo (slave speaker).

**1 uscita di segnale mono (subwoofer attivi).**

1 RJ45 per rete LAN.  
Alimentatore input 100-240Vac, output 26Vdc (fornito in dotazione).  
Dimensioni 172x1015x210 mm (LxHxP). Peso 14Kg. Cabinet in legno. Finiture alluminio spazzolato.  
Calza colore di serie: nero.  
Telecomando fornito in dotazione.

**ACTIVE multimedia stereo speaker kit with integrated Bluetooth and Keysol WiFi player.**

Vivaldi supervision and control APP (downloadable from iOS & Android). DSP, class-D power amplifier, 70+70W RMS @ 4Ω.

Woofer 2x15 cm. Dome tweeter 2.5cm. Frequency response 45-20000Hz +-5dB. Maximum output level 112dB. 115 peak. 1 LINE input.

1 Digital input (coaxial and Toslink)  
1 USB Type-A on the rear for MP3/WMA/AAC/AAC+/ALAC/FLAC/APE/WAV audio file playback.  
1 power output for second passive (slave) speaker.

**1 mono signal output (active subwoofer).**

1 RJ45 per LAN.  
Power supply input 100-240Vac, output 26Vdc (included).  
Size 172x1015x210 mm (WxHxD).  
Weight 14Kg.  
Wooden cabinet. Brushed aluminium finishes. Standard colored cover black.  
Remote control included.









# Kit multimediali con diffusori per esterni

Outdoor multimedia speakers kit



## KBOX

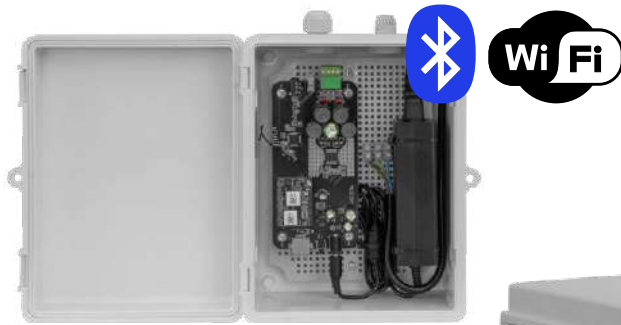

### CAMPI APPLICATIVI application fields



### KBOX

**Amplificatore multimediale Bluetooth e WiFi con player multimediale integrato.**  
Con ingressi per sorgenti locali ed uscite per 1 o 2 diffusori.

Streaming musicale, riproduzioni e controlli tramite **VIVALDI APP**.

#### CARATTERISTICHE TECNICHE

- Ricevitore Bluetooth integrato.
- Ricevitore WiFi integrato.
- APP di controllo gratuita: Vivaldi APP (compatibile con iOS - Android).
- Supporta: Airplay, DLNA, WiFi DIRECT.
- Formati audio: AAC/LTP, HE-AACv1, HE-AACv2, AMR-NB, AMR, WB, FLAC, MP3, Vorbis, PCM/WAVE, ALAC.
- Rete: 1xRJ45, WiFi Standard: IEEE802.11b, IEEE802.11g, IEEE802.11n.
- Ingressi Audio: 1x Minijack stereo analogico.
- **Uscite Audio: Stereo con potenza amplificatore classe-D 40+40W @ 8-16Ω, non compatibile con diffusori a 4Ω.**
- **Sorgenti internet: Spotify, Tuneln, ecc.**
- Sorgenti locali: musica residente nel proprio dispositivo mobile, streaming da NAS (disco di rete).
- 3 Modalità di utilizzo:
  1. One song-One Room: utilizzo di un singolo dispositivo.
  2. One song-Multiple Rooms: utilizzo di più dispositivi per musiche differenti.
  3. One song-All Rooms: utilizzo di più dispositivi per la stessa musica sincronizzata.
- Alimentazione 24Vdc tramite alimentatore in dotazione.
- Contenitore stagno IP65, per installazione all'esterno.
- Colore grigio.
- 3x pressacavi in dotazione.
- Certificazioni: CE, ROHS.
- Dimensioni (LxHxP): 180x230x120 mm.
- Peso 0,45 Kg.

**Bluetooth and WiFi multimedia amplifier with integrated multimedia player.**

**With input for external source and outputs for 1 or 2 speakers.**

Music streaming, playback and controls via **VIVALDI APP**.

#### TECHNICAL FEATURES

- Built-in Bluetooth receiver.
- Built-in WiFi receiver.
- Free control APP: Vivaldi APP (compatible with iOS - Android).
- Supports: Airplay, DLNA, WiFi DIRECT.
- Audio formats: AAC/LTP, HE-AACv1, HE-AACv2, AMR-NB, AMR, WB, FLAC, MP3, Vorbis, PCM/WAVE, ALAC.
- Network: 1xRJ45, WiFi Standard: IEEE802.11b, IEEE802.11g, IEEE802.11n.
- Audio Input: 1x Analog stereo minijack.
- **Audio Output: Stereo power amplifier class-D 40+40W @ 8-16Ω, not compatible with 4Ω speakers.**
- **Internet sources: Spotify, Youtube, Tunein, etc.**
- Local sources: music residing on your mobile device, streaming from NAS (network disk).
- 3 How to use:
  1. One song-One Room: use of a single device.
  2. One song-Multiple Rooms: use of multiple devices for different music.
  3. One song-All Rooms: use multiple devices for the same synchronized music.
- 24vdc power supply included.
- IP65 watertight enclosure, for outdoor installation.
- Colour: grey.
- 3x supplied cable glands.
- Certifications: CE, ROHS.
- Dimensions (WxHxD): 180x230x120 mm.
- Weight 0.45 Kg.

# KEYROCK20A



Spotify +tunein dlna



## CAMPI APPLICATIVI application fields



### KEYROCK20A

#### Kit diffusore Wireless & Bluetooth per il giardino e gli spazi all'aperto.

Streaming bluetooth dal proprio dispositivo (smartphone, pc, tablet ...).

Streaming WiFi tramite APP VIVALDI (iOS, Android) con YouTube, Spotify, WebRadio, NAS, ecc...

#### Composto da:

##### 1) KBOX

Amplificatore multimediale Bluetooth e WiFi con player multimediale integrato.

Con ingressi per sorgenti locali. Streaming musicale, riproduzioni e controlli tramite VIVALDI APP.

Uscite Audio: Stereo con potenza amplificatore classe-D **40+40W @ 8-16Ω**, non compatibile con diffusori a 4Ω.

Alimentazione 24Vdc tramite alimentatore in dotazione. Contenitore stagno IP65, per installazione all'esterno.

Colore grigio.

3x pressacavi in dotazione.

Dimensioni (LxHxP): 180x230x120 mm.

Peso 0,45 Kg.

##### 1) ROCK20T

Diffusore simil roccia, 2 vie coax, Hi-Fi, da giardino IP56 waterproof.

Woofer: 20 cm in polipropilene.

Tweeter: 2,5cm in titanio con magnete al neodimio.

Dimensioni (LxHxP) 440x300x300 mm.

Colore grigio simil roccia.

Cabinet: fibra di vetro verniciata.

Angolo di dispersione: 120°(O)x120°(V).

Temperatura di lavoro da -20° a +60°.

#### Wireless & Bluetooth speaker kit for garden and outdoor environment.

Bluetooth streaming from your device (smartphone, pc, tablet ...).

WiFi streaming via VIVALDI APP (iOS, Android) with YouTube, Spotify, Webradio, NAS, etc...

#### Included:

##### 1) KBOX

Bluetooth and WiFi amplifier with integrated multimedia player.

With input for external source. Music streaming, playback and controls via VIVALDI APP.

Audio Output: Stereo power amplifier class-D **40+40W @ 8-16Ω**, not compatible with 4Ω speakers.

24vdc power supply included.

IP65 watertight enclosure, for outdoor installation.

Colour: Grey.

3x cable glands included.

Dimensions (WxHxD): 180x230x120 mm.

Weight 0.45 Kg.

##### 1) ROCK20T

Rock-like speaker, 2-way coax, Hi-Fi, garden IP56 waterproof.

Woofer: 20 cm in polypropylene.

Tweeter: 2,5cm titanium with neodymium magnet.

Dimensions (WxHxD) 440x300x300 mm.

Rock-like grey colour.

Cabinet: painted fiberglass.

Dispersion angle: 120° (H)x120° (V).

Working temperature from -20° to +60°.



# KEYGREEN16A



## CAMPI APPLICATIVI application fields



### KEYGREEN16A

#### Kit diffusore Wireless & Bluetooth per il giardino e gli spazi all'aperto.

Streaming bluetooth dal proprio dispositivo (smartphone, pc, tablet ...).  
Streaming WiFi tramite APP VIVALDI (iOS, Android) con YouTube, Spotify, WebRadio, NAS, ecc...

#### Composto da:

##### 1) KBOX

Amplificatore multimediale Bluetooth e WiFi con player multimediale integrato.

Con ingressi per sorgenti locali. Streaming musicale, riproduzioni e controlli tramite VIVALDI APP.

Uscite Audio: Stereo con potenza amplificatore classe-D **40+40W @ 8-16Ω**, non compatibile con diffusori a 4Ω.

Alimentazione 24Vdc tramite alimentatore in dotazione. Contenitore stagno IP65, per installazione all'esterno.

Colore grigio.

3x pressacavi in dotazione.

Dimensioni (LxHxP): 180x230x120 mm.

Peso 0,45 Kg.

##### 1) GREEN16T

Diffusore, 2 vie coax, Hi-Fi, da giardino IP56 waterproof.

Woofer: 16,5 cm in polipropilene.

Tweeter: 3 cm in titanio magnete neodimio.

Dimensioni (DxH) 365x409 mm.

Peso 3 Kg.

Colore verde.

Cabinet: polipropilene UV.

Angolo di dispersione: 360°(O)x40°(V).

Temperatura di lavoro da -20° a +60°.

#### Wireless & Bluetooth speaker kit for garden and outdoor environment.

Bluetooth streaming from your device (smartphone, pc, tablet ...).

WiFi streaming via VIVALDI APP (iOS, Android) with YouTube, Spotify, Webradio, NAS, etc...

#### Included:

##### 1) KBOX

Bluetooth and WiFi amplifier with integrated multimedia player.

With input for external source. Music streaming, playback and controls via VIVALDI APP.

Audio Output: Stereo power amplifier class-D **40+40W @ 8-16Ω**, not compatible with 4Ω speakers.

24vdc power supply included.

IP65 watertight enclosure, for outdoor installation.

Colour: Grey.

3x cable glands included.

Dimensions (WxHxD): 180x230x120 mm.

Weight 0.45 Kg.

##### 1) GREEN16T

Speaker, 2-way coax, Hi-Fi, garden IP56 waterproof.

Woofer: 16,5 cm in polypropylene.

Tweeter: 3 cm titanium with neodymium magnet.

Dimensions (WxH) 365x409 mm.

Colour: Green.

Cabinet: UV polypropylene.

Dispersion angle: 360°(H)x40°(V).

Working temperature from -20° to +60°.



# KEYZEN315A

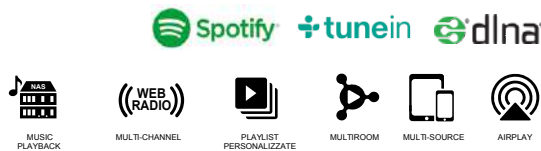
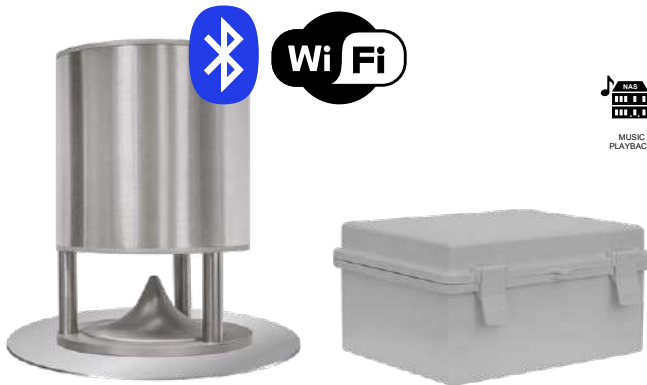

## CAMPI APPLICATIVI application fields



### KEYZEN315A

#### Kit diffusore Wireless & Bluetooth per il giardino e gli spazi all'aperto.

Streaming bluetooth dal proprio dispositivo (smartphone, pc, tablet ...).

Streaming WiFi tramite APP VIVALDI (iOS, Android) con YouTube, Spotify, WebRadio, NAS, ecc...

#### Composto da:

##### 1) KBOX

Amplificatore multimediale Bluetooth e WiFi con player multimediale integrato.

Con ingressi per sorgenti locali. Streaming musicale, riproduzioni e controlli tramite VIVALDI APP.

Uscite Audio: Stereo con potenza amplificatore classe-D **40+40W @ 8-16Ω**, non compatibile con diffusori a 4Ω.

Alimentazione 24Vdc tramite alimentatore in dotazione. Contenitore stagno IP65, per installazione all'esterno. Colore grigio.

3x pressacavi in dotazione.

Dimensioni (LxHxP): 180x230x120 mm. Peso 0,45 Kg.

##### 1) ZEN315

Diffusore di design, HiFi, 2 vie, in acciaio Inox 316L, IP65, per diffusioni sonore ed arredamenti da esterno (terrazze, giardini, piscine...).

Woofer da 16,5cm.

Tweeter a cupola da 2,5cm.

Dimensioni 205 x 315 mm (DxH).

Flangia di ancoraggio 30 cm (D).

Fori di ancoraggio nr. 3.

Peso 7 Kg. Colore acciaio spazzolato.

Personalizzazione colore su richiesta.

#### Wireless & Bluetooth speaker kit for gardens and outdoor environments.

Bluetooth streaming from your device (smartphone, pc, tablet ...).

WiFi streaming via VIVALDI APP (iOS, Android) with YouTube, Spotify, Webradio, NAS, etc...

#### Included:

##### 1) KBOX

Bluetooth and WiFi amplifier with integrated multimedia player.

With input for external source. Music streaming, playback and controls via VIVALDI APP.

Audio Output: Stereo power amplifier class-D **40+40W @ 8-16Ω**, not compatible with 4Ω speakers.

24vdc power supply included.

IP65 watertight enclosure, for outdoor installation.

Colour: Grey.

3x cable glands included.

Dimensions (WxHxD): 180x230x120 mm. Weight 0.45 Kg.

##### 1) ZEN315

Speaker design, hifi, 2-way, in 316L stainless steel, IP65, for sound broadcasting in outdoor environments (terraces, gardens, swimming pools...).

16.5 cm woofer.

2.5cm dome tweeter.

Dimensions 205 x 315 mm (WxH).

Anchor flange 30 cm (D).

Anchoring holes nr. 3.

Weight 7 Kg. Colour brushed steel.

Color customization on request.

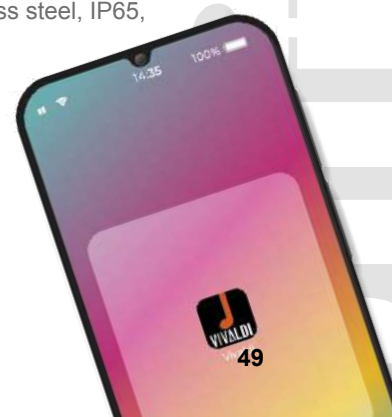

# KEYZEN510A



Spotify +tunein dlna



MUSIC  
PLAYBACK



MULTI-CHANNEL



PLAYLIST  
PERSONALIZZATE



MULTIROOM



MULTI-SOURCE



AIRPLAY

## CAMPI APPLICATIVI application fields



### KEYZEN510A

#### Kit diffusore Wireless & Bluetooth per il giardino e gli spazi all'aperto.

Streaming bluetooth dal proprio dispositivo (smartphone, pc, tablet ...).

Streaming WiFi tramite APP VIVALDI (iOS, Android) con YouTube, Spotify, WebRadio, NAS, ecc...

#### Composto da:

##### 1) KBOX

Amplificatore multimediale Bluetooth e WiFi con player multimediale integrato.

Con ingressi per sorgenti locali. Streaming musicale, riproduzioni e controlli tramite VIVALDI APP.

Uscite Audio: Stereo con potenza amplificatore classe-D **40+40W @ 8-16Ω**, non compatibile con diffusori a 4Ω.

Alimentazione 24Vdc tramite alimentatore in dotazione.

Contenitore stagno IP65, per installazione all'esterno.

Colore grigio.

3x pressacavi in dotazione.

Dimensioni (LxHxD): 180x230x120 mm. Peso 0,45 Kg.

##### 1) ZEN510

Diffusore di design con illuminazione a LED integrata, HiFi, 2 vie, in acciaio Inox 316L, IP65, per diffusioni sonore ed arredamenti da esterno (terrazze, giardini, piscine...). 66 Led, 13,8W, 1380lm, 3800K.

Woofer da 16,5 cm.

Tweeter a cupola da 2,5cm.

Dimensioni 205 x 510 mm (DxH).

Flangia di ancoraggio 30 cm (D).

Fori di ancoraggio nr. 3.

Peso 8,2 Kg. Colore acciaio spazzolato.

Personalizzazione colore su richiesta.

#### Wireless & Bluetooth speaker kit for gardens and outdoor environments.

Bluetooth streaming from your device (smartphone, pc, tablet ...).

WiFi streaming via VIVALDI APP (iOS, Android) with YouTube, Spotify, Webradio, NAS, etc...

#### Included:

##### 1) KBOX

Bluetooth and WiFi amplifier with integrated multimedia player.

With input for external source. Music streaming, playback and controls via VIVALDI APP.

Audio Output: Stereo power amplifier class-D **40+40W @ 8-16Ω**, not compatible with 4Ω speakers.

24vdc power supply included.

IP65 watertight enclosure, for outdoor installation.

Colour: Grey.

3x cable glands included.

Dimensions (WxHxD): 180x230x120 mm. Weight 0.45 Kg.

##### 1) ZEN510

Speaker design, with integrated LED lighting, hifi, 2-way, in 316L stainless steel, IP65, for sound broadcasting in outdoor environments (terraces, gardens, swimming pools...). M66 Led, 13,8W, 1380lm, 3800K.

16.5 cm woofer.

2.5cm dome tweeter.

Dimensions 205 x 510 mm (WxH).

Anchor flange 30 cm (D).

Anchoring holes nr. 3.

Weight 8,2 Kg. Colour brushed steel.

Color customization on request.

# KEYZEN730A

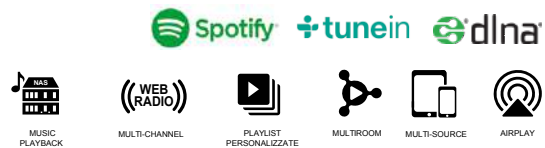

## CAMPI APPLICATIVI application fields



### KEYZEN730A

#### Kit diffusore Wireless & Bluetooth per il giardino e gli spazi all'aperto.

Streaming bluetooth dal proprio dispositivo (smartphone, pc, tablet ...).

Streaming WiFi tramite APP VIVALDI (iOS, Android) con YouTube, Spotify, WebRadio, NAS, ecc...

#### Composto da:

##### 1) KBOX

Amplificatore multimediale Bluetooth e WiFi con player multimediale integrato.

Con ingressi per sorgenti locali. Streaming musicale, riproduzioni e controlli tramite VIVALDI APP.

Uscite Audio: Stereo con potenza amplificatore classe-D **40+40W @ 8-16Ω**, non compatibile con diffusori a 4Ω.

Alimentazione 24Vdc tramite alimentatore in dotazione. Contenitore stagno IP65, per installazione all'esterno. Colore grigio.

3x pressacavi in dotazione.

Dimensioni (LxHxP): 180x230x120 mm. Peso 0,45 Kg.

##### 1) ZEN730

Diffusore di design, HiFi, 2 vie, in acciaio Inox 316L, IP65, per diffusioni sonore ed arredamenti da esterno (terrazze, giardini, piscine...).

Woofer da 16,5cm.

Tweeter da 2,5cm a compressione.

Dimensioni 205 x 725 mm (DxH).

Flangia di ancoraggio 30 cm (D).

Fori di ancoraggio nr. 3.

Peso 12,5 Kg. Colore acciaio spazzolato.

Personalizzazione colore su richiesta.

#### Wireless & Bluetooth speaker kit for gardens and outdoor environments.

Bluetooth streaming from your device (smartphone, pc, tablet ...).

WiFi streaming via VIVALDI APP (iOS, Android) with YouTube, Spotify, Webradio, NAS, etc...

#### Included:

##### 1) KBOX

Bluetooth and WiFi amplifier with integrated multimedia player.

With input for external source. Music streaming, playback and controls via VIVALDI APP.

Audio Output: Stereo power amplifier class-D **40+40W @ 8-16Ω**, not compatible with 4Ω speakers.

24vdc power supply included.

IP65 watertight enclosure, for outdoor installation.

Colour: Grey.

3x cable glands included.

Dimensions (WxHxD): 180x230x120 mm. Weight 0.45 Kg.

##### 1) ZEN730

Speaker design, hifi, 2-way, in 316L stainless steel, IP65, for sound broadcasting in outdoor environments (terraces, gardens, swimming pools...).

16,5 cm woofer.

2,5cm dome tweeter.

Dimensions 205 x 725 mm (WxH).

Anchor flange 30 cm (D).

Anchoring holes nr. 3.

Weight 12,5 Kg. Colour brushed steel.

Color customization on request.

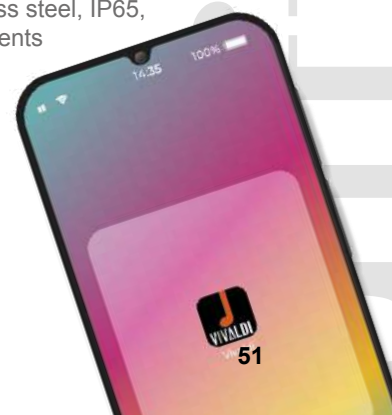







Amplificatori integrati

# Professionali

multimedia player  
con APP



# Freedom

Con Keysol puoi avere contemporaneamente musica differente in ogni ambiente. Oppure puoi uniformare la diffusione sonora in modo totale, parziale o in gruppi di zone (la comodità del multiroom). Solo con Keysol potrai gestire le varie zone attraverso l'App Vivaldi scaricabile da Apple Store e Google Play. Si chiama libertà.

*With Keysol you can have simultaneously different music in every environment. Or you can standardize the sound diffusion in a total, partial or in groups of zones (the convenience of multiroom). Only with Keysol you can manage the various zones through the Vivaldi App downloadable from Apple Store and Google Play. It's called freedom.*



Soggiorno

AL9 P80



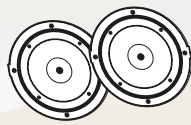

Cameretta



Cucina



Bagno



Camera



Porticato

AL6 P30

AL6 P30

AL6 P30

AL6 P30

AL9 P80

AL9 E80

Vano tecnico

Sub zona

**INTERNET**

SWITCH  
(tipo Layer3)

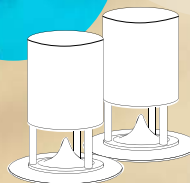

Piscina

55



# P30S

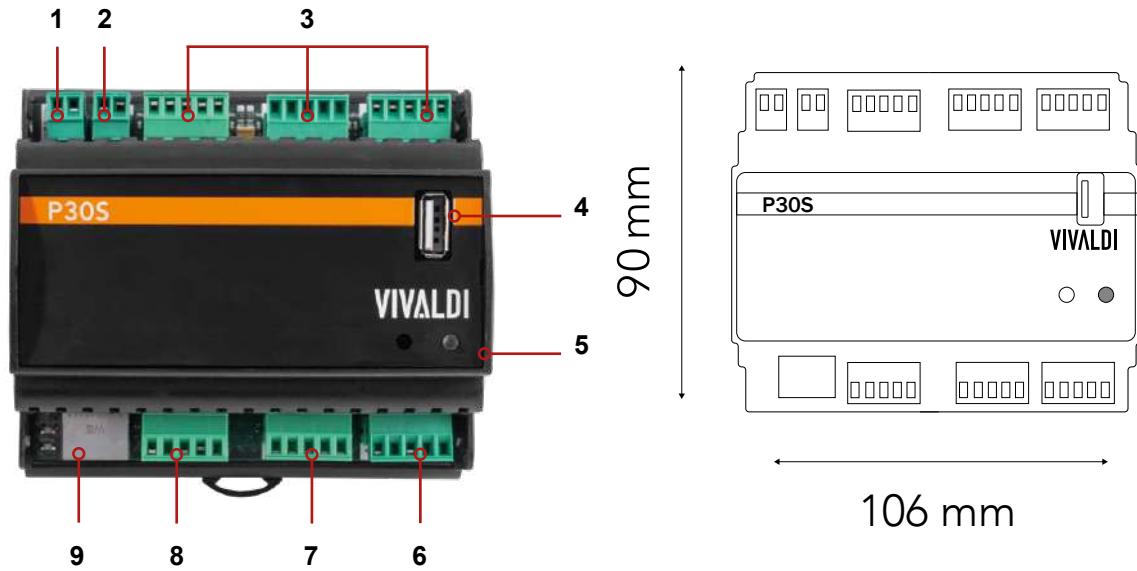

**1**  
Alimentazione 24V  
24V power supply

**2**  
Contatto Priorità  
Contact Priority

**3**  
Ingressi stereo bilanciato  
configurabili  
Configurable balanced stereo  
inputs

**4**  
Porta USB per Upg FW e  
riproduzione file  
USB port for Upg FW and file  
playback

**5**  
Pulsante multifunzione e led di  
stato  
Multifunction button and status  
LED

**6**  
Uscita amplificata per speakers  
Amplified output for speakers

**7**  
Uscita audio preout bilanciato  
Balanced pre-out audio output

**8**  
Uscita audio linea/subwoofer  
Audio line/subwoofer output

**9**  
Porta RJ45 per connessione a rete  
LAN  
RJ45 port for LAN connection

## ALIMENTAZIONE power supply

AL5B (24 Vdc 4,16A, 100W)  
AL6B (24 Vdc 6,25A, 150W)  
AL7B (24 Vdc 10A, 240W)

## ACCESSORI accessories

E30S  
E80S

## CAMPI APPLICATIVI application fields



## P30S

**Amplificatore di potenza, stereo, multicanale, domotico, con player multimediale integrato. Mixer amplificato con DSP a 4 canali mono + 1 stereo oppure 3ch stereo. Potenza amplificatore classe-D 30+30W @ 8Ω, 50+50W @ 4Ω.**  
 APP di supervisione e controllo VIVALDI (scaricabile da iOS & Android).  
**API disponibili:**  
 -KNXnet-IP (KNX IP Router necessario non di nostra fornitura)  
 -Protocollo MQTT 3.1 (tramite Broker esterno oppure integrato)  
 -REST-API (HTTP GET/POST)  
**4x INGRESSI MIC/LINE selezionabili con Phantom attivabile (24Vdc), priorità assegnabile (attivabile con contatto).**  
 USB type A su frontale per riproduzione file audio MP3/WMA/AAC/AAC+/ALAC/FLAC/APE/WAV.  
 Equalizzatore a 7 bande.  
 Uscita mono per subwoofer attivi.  
 Uscita stereo per espansioni di potenza E30S, E80S o finali di potenza Linea Vivaldi Ulisse a 8Ω o 100V.  
 1x RJ45 per rete LAN.  
 1x cavo PATCH da 1mt.  
 Controllo parametri audio con gestione volumi/settaggi/... da webpage.  
 Integrabile a domotiche terze o ai dispositivi domotici multiprotocollo iCONTROL4.1L, iCONTROL4.0+ tramite rete LAN. Alimentazione 24Vdc tramite AL5B (non in dotazione). Standard DIN (6 moduli).  
 Dimensioni (LxHxP): 106x90x63 mm. Peso 0.2 Kg.



**Multimedia stereo device with built-in multimedia player. DSP amplified mixer with 4-channel mono + 1 stereo or 3 stereo ch.**  
**Class-D amplifier power 30+30W @ 8Ω, 50+50W @ 4Ω.**  
 VIVALDI supervision and control APP (downloadable from iOS & Android).  
**API available:**  
 -KNXnet-IP (KNX IP mandatory Router is not provided)  
 -Protocollo MQTT 3.1 (through external Broker or integrated)  
 -REST-API (HTTP GET/POST)  
 4x SELECTABLE MIC/LINE INPUTS with activable Phantom (24Vdc), assignable priority (can be activated with contact).  
 USB Type A on the front for MP3/WMA/AAC/AAC+/ALAC/FLAC/APE/WAV audio file playback.  
 7-band equalizer.  
 Mono output for active subwoofers.  
 Stereo output for power expansions E30S, E80S or power amps Vivaldi Ulisse Line at 8Ω or 100V.  
 1x RJ45 per LAN.  
 1x PATCH cable 1mt.  
 Audio parameter control with volume/settings/... from webpage. Can be integrated with home automation systems iCONTROL4.1L, iCONTROL4.0+ via LAN.  
 Power Supply 24Vdc via AL5B (not included).  
 DIN standard (6 modules).  
 Size (WxHxD): 106x90x63 mm.  
 Weight 0.2 Kg.

## AL5B

Alimentatore da barra DIN (7,5 moduli). Input 100-240 Vac 50Hz 1,2A. Output 24 Vdc 4,16A, 100W. Colore nero. Dimensioni 138x88x65 mm (LxHxP). Peso 0,33 Kg.



DIN rail power supply (7,5 modules) Input 100-240 Vac 50Hz 1,2A Output 24 Vdc, 4,16A, 100W. Size: 138x88x65 mm (WxHxD). Weight 0,33 Kg.

## AL6B

Alimentatore da barra DIN (6 moduli). Input 100-240 Vac 50Hz 1,8A. Output 24 Vdc 6,25A, 150W. Colore nero. Dimensioni 103x58x90 mm (LxHxP). Peso 0,35 Kg.



DIN rail power supply (6 modules). Input 100-240 Vac 50Hz 1,8A. Output 24 Vdc 6,25A, 150W. Black colour. Size 103x58x90 mm (WxHxD). Weight 0,35 Kg.

## AL7B NEW

Alimentatore da barra DIN. Input 100-240 Vac 50/60Hz 2,6A. Output 24 Vdc 10A, 240W. Dimensioni 65x126x110 mm (LxHxP). Peso 1,1 Kg. Colore nero.

DIN rail power supply. Input 100-240 Vac 50/60Hz 2,6A. Output 24 Vdc 10A, 240W. Size 65x126x110 mm (WxHxD). Weight 1,1 Kg. Black

# P80S

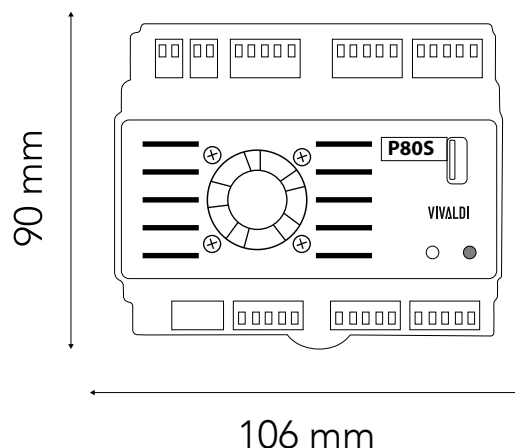
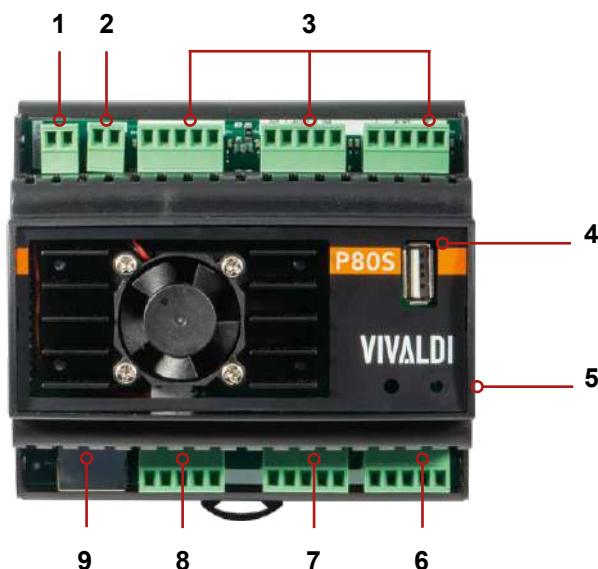

**1**  
Alimentazione 36V  
power supply 36V

**2**  
Contatto Priorità  
Contact Priority

**3**  
3 Ingressi stereo bilanciato  
configurabili  
3 Configurable balanced stereo  
inputs

**4**  
Porta USB per Upg FW e  
riproduzione file  
USB port for Upg FW and file  
playback

**5**  
Pulsante multifunzione e led di  
stato  
Multifunction button and status  
LED

**6**  
Uscita amplificata per speaker  
Amplified output for speaker

**7**  
Uscita audio preout bilanciato  
Balanced pre-out audio output

**8**  
Uscita audio linea/subwoofer  
Audio line / subwoofer output

**9**  
Porta RJ45 per connessione a rete  
LAN  
RJ45 port for LAN connection

## ALIMENTAZIONE power supply

AL9B (36 Vdc 4,2A, 150W)  
AL10B (36 Vdc 6,6A, 240W)  
AL203 (36 Vdc 9,7A)

## ACCESSORI accessories

E30S  
E80S

## CAMPI APPLICATIVI application fields





## P80S

Amplificatore di potenza, stereo, multicanale, domotico, con player multimediale integrato. Mixer amplificato con DSP a 4 canali mono + 1 stereo oppure 3ch stereo. Potenza amplificatore classe-D 80+80W @ 8Ω, 140+140W @ 4Ω. APP di supervisione e controllo VIVALDI (scaricabile da iOS & Android).

**API disponibili:**

**-KNXnet-IP**

(KNX IP Router necessario non di nostra fornitura)

**-Protocollo MQTT 3.1**

(tramite Broker esterno oppure integrato)

**-REST-API (HTTP GET/POST)**

4x INGRESSI MIC/LINE selezionabili con Phantom attivabile (24Vdc), priorità assegnabile (attivabile con contatto). USB type A su frontale per riproduzione file audio MP3/WMA/AAC/AAC+/ALAC/FLAC/APE/WAV. Equalizzatore a 7 bande. Uscita mono per subwoofer attivi. Uscita stereo per espansioni di potenza E30S, E80S o finali di potenza Linea Vivaldi Ulisse a 8Ω o 100V.

1x RJ45 per rete LAN. 1x cavo PATCH da 1mt.

Controllo parametri audio con gestione volumi/settaggi/... da webpage. Integrabile a domotiche terze o ai dispositivi domotici multiprotocollo iCONTROL4.1L, iCONTROL4.0+ tramite rete LAN. Alimentazione 36Vdc tramite AL9B (non in dotazione). Standard DIN (6 moduli).

Dimensioni (LxHxP): 106x90x63 mm. Peso 0.23 Kg.



## AL9B

Alimentatore da barra DIN (6 moduli)

Input 100-240 Vac 50Hz 1,8A

Output 36 Vdc 4,2A, 150W

Colore nero

Dimensioni 103x58x90 mm (LxHxP)

Peso 0,35 Kg



## AL10B



Alimentatore da barra DIN

Input 100-240 Vac 50Hz 1,2A

Output 36 Vdc 6,6A, 240W

Colore nero

Dimensioni 65x126x110 mm (LxHxP) Peso 1,1 Kg



## AL203

Alimentatore ventilato.

Input 180-264 Vac 50-60Hz 9,7A, 350W.

Output 36 Vdc 9,7A.

Dimensioni 215x115x50 mm (LxHxP).

Peso 1 Kg.

Multimedia stereo device with built-in multimedia player. DSP amplified mixer with 4-channel mono + 1 stereo or 3 stereo ch. Class-D amplifier power 80+80W @ 8Ω, 140+140W @ 4Ω. VIVALDI supervision and control APP (downloadable from iOS & Android).

**API available:**

**-KNXnet-IP (KNX IP mandatory Router is not provided)**

**-Protocollo MQTT 3.1**

(through external Broker or integrated)

**-REST-API (HTTP GET/POST)**

4x SELECTABLE MIC/LINE INPUTS with activable Phantom (24Vdc), assignable priority (can be activated with contact). USB Type A on the front for MP3/WMA/AAC/AAC+/ALAC/FLAC/APE/WAV audio file playback. 7-band equalizer. Mono output for active subwoofers.

Stereo output for power expansions E30S, E80S or power amps Vivaldi Ulisse Line at 8Ω or 100V.

1x RJ45 per LAN. 1x PATCH cable 1mt.

Audio parameter control with volume/settings/... from webpage. Can be integrated with home automation systems iCONTROL4.1L, iCONTROL4.0+ via LAN. Power Supply 36Vdc via AL9B (not included). DIN standard (6 modules).

Size (WxHxD) 105x65x90 mm. Weight 0.23 Kg.

DIN rail power supply (6 modules)

Input 100-240 Vac 50Hz 1,8A

Output 36 Vdc 4,2A, 150W

Black colour

Size: 103x58x90 mm (WxHxD)

Weight 0,35 Kg

DIN rail power supply

Input 100-240 Vac 50Hz 1,2A

Output 36 Vdc 6.6A, 240W

Black

Size: 65x126x110 mm (WxHxD) Weight 1,1 Kg

Power supply, with fan

Input: 180-264 Vac 50-60Hz 9,7A, 350W.

Output: 36 Vdc 9,7A.

Size: 215x115x50 mm (WxHxD)

Weight 1 Kg.

## P30S MULTIMEDIA AMPLIFIER

AREA COMMERCIALE E MAGAZZINO

CON REGISTRATORE GENERATORE DI MESSAGGI E BASI MICROFONICHE

SALES AREA AND WAREHOUSE WITH MESSAGES REC AND PLAYER AND MICROPHONE BASE

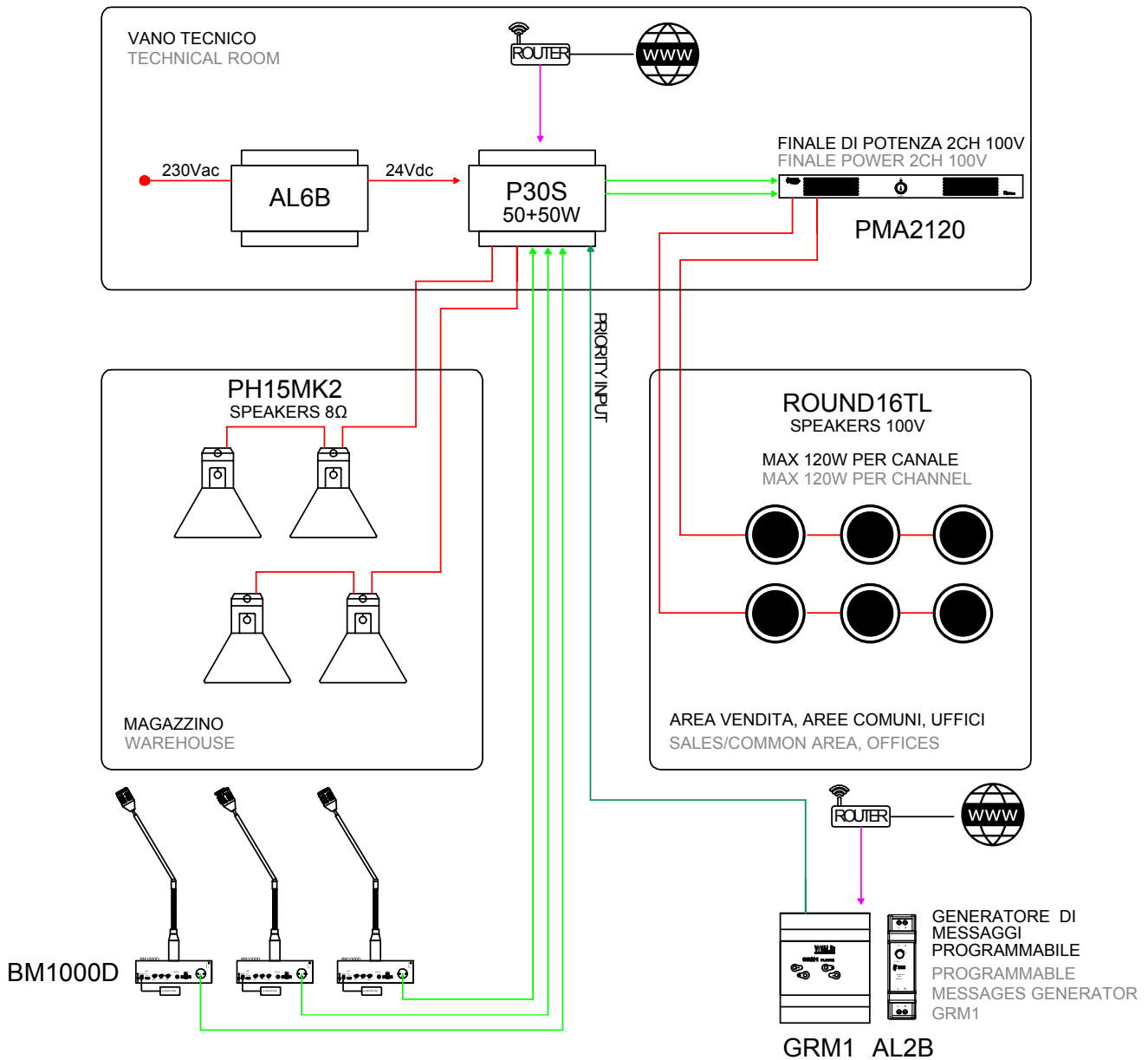

### CABLE LEGEND

- CAVO DI ALIMENTAZIONE POLARIZZATO 2x1mm  
POLARIZED CABLE FOR POWER SUPPLY 2x1mm
- CAVO MICRO2  
MICRO2 CABLE
- CAVO CAT6  
CAT6 CABLE
- CAVO MICRO4  
MICRO4 CABLE

APP (iOS & ANDROID)  
gestione e controllo WiFi  
WiFi management and control

## P30S MULTIMEDIA AMPLIFIER

SALA RISTORANTE CON STREAMING ED INGRESSO PER RADIOMICROFONO  
 RESTAURANT ROOM WITH STREAMING AND INPUT FOR WIRELESS MICROPHONE

### GIADA/ROUND16F

SPEAKERS 8Ω

MAX 2 COLLEGATE IN PARALLELO PER CANALE  
 MAX 2 LINKED IN PARALLEL FOR CHANNEL

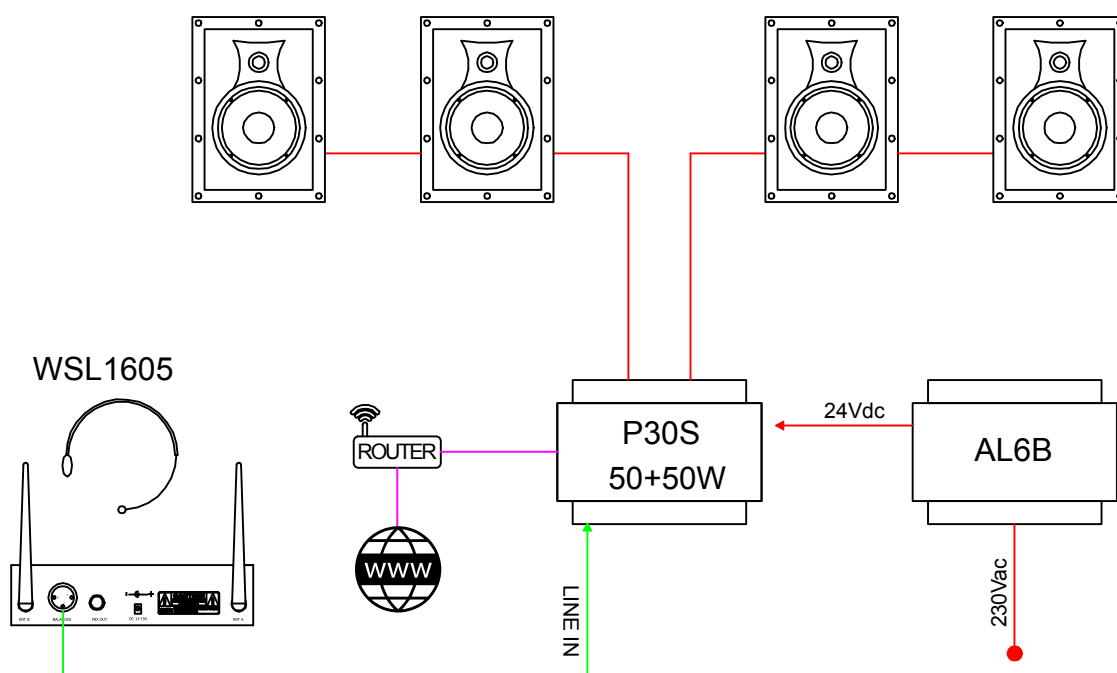

#### CABLE LEGEND

- CAVO DI ALIMENTAZIONE POLARIZZATO 2x1mm  
POLARIZED CABLE FOR POWER SUPPLY 2x1mm
- CAVO MICRO2  
MICRO2 CABLE
- CAVO CAT6  
CAT6 CABLE

APP (iOS & ANDROID)  
 gestione e controllo WiFi  
 WiFi management and control





## P30S MULTIMEDIA AMPLIFIER

NEGOZIO CON STREAMING ED INGRESSO PER MICROFONO  
SHOP WITH STREAMING AND INPUT FOR MICROPHONE

### INVISIBLE65

SPEAKERS 8Ω

MAX 2 COLLEGATE IN PARALLELO PER CANALE  
MAX 2 LINKED IN PARALLEL FOR CHANNEL

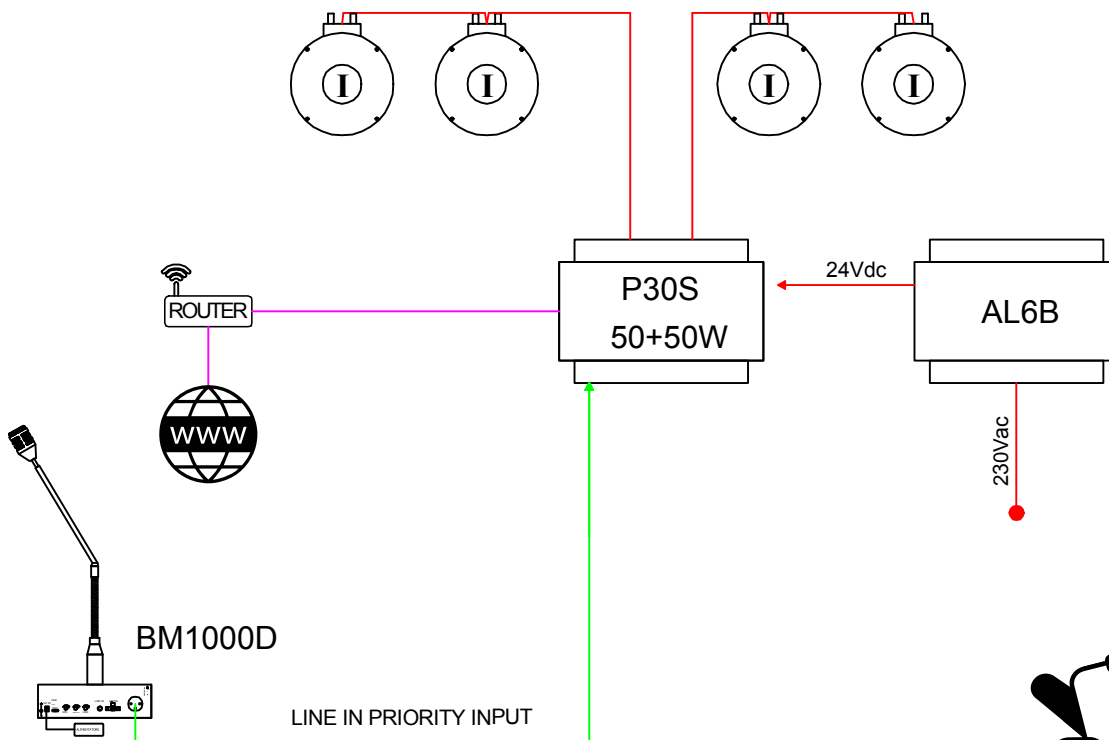

#### CABLE LEGEND

- CAVO DI ALIMENTAZIONE POLARIZZATO 2x1mm  
POLARIZED CABLE FOR POWER SUPPLY 2x1mm
- CAVO MICRO4  
MICRO4 CABLE
- CAVO CAT6  
CAT6 CABLE

APP (iOS & ANDROID)  
gestione e controllo WiFi  
WiFi management and control



## P30S+E30S MULTIMEDIA SYSTEM

CAFFETTERIA MULTIZONA 4 VOLUMI INDIPENDENTI CON PLAYER MULTIMEDIALE  
 MULTIZONE COFFEE SHOP WITH 4 INDEPENDENT VOLUMES AND MULTIMEDIA PLAYER

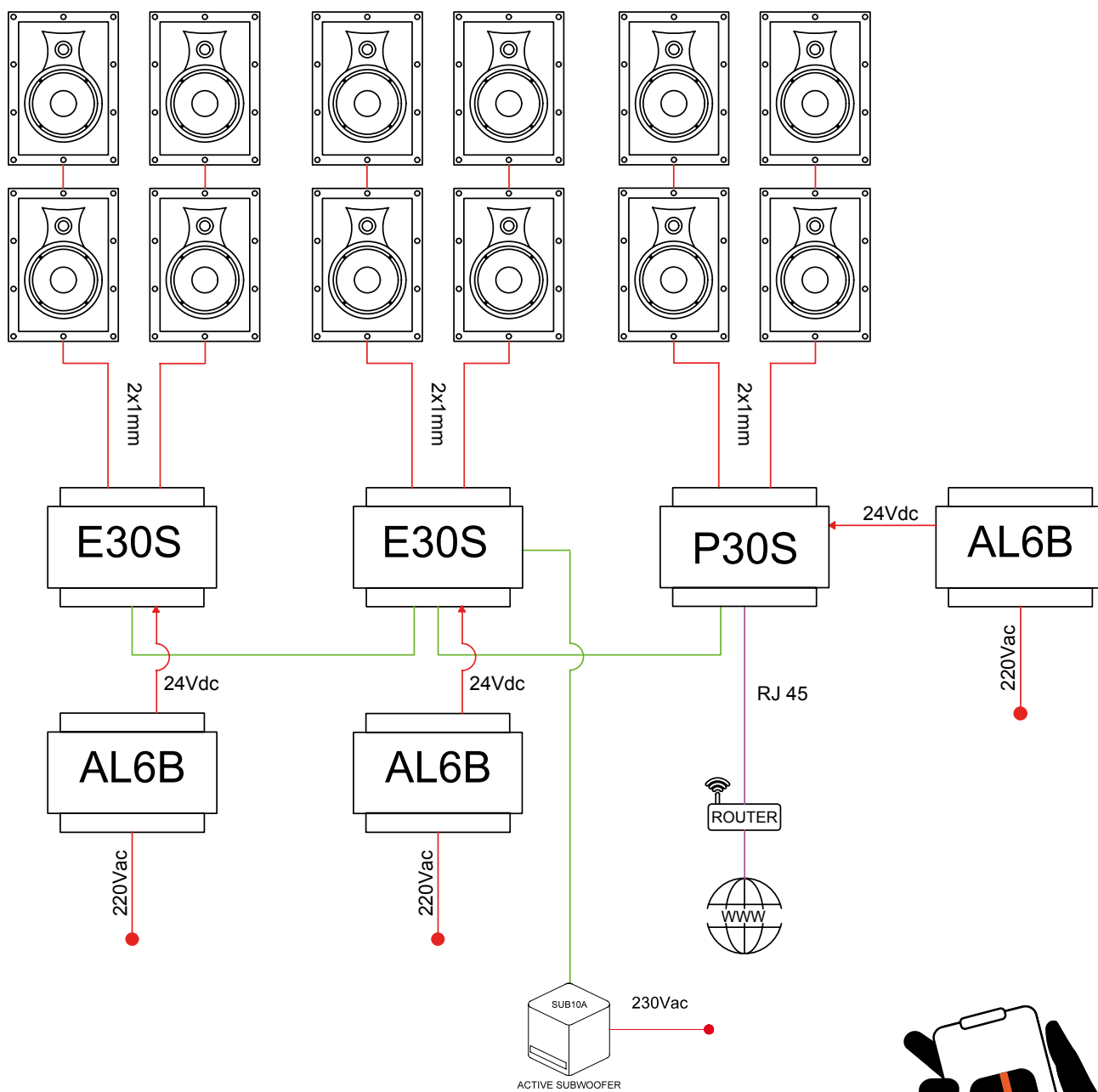

APP (iOS & ANDROID)  
 gestione e controllo WiFi

## P80S MULTIMEDIA AMPLIFIER

PUB CON AUDIO STREAMING E SUBWOOFER PER MUSICHE AD ALTO VOLUME  
 PUB WITH STREAMING AUDIO AND SUBWOOFER FOR LOUD MUSIC

### GIADA20SPF SPEAKERS 8Ω

MAX 2 COLLEGATE IN PARALLELO PER CANALE  
 MAX 2 LINKED IN PARALLEL FOR CHANNEL

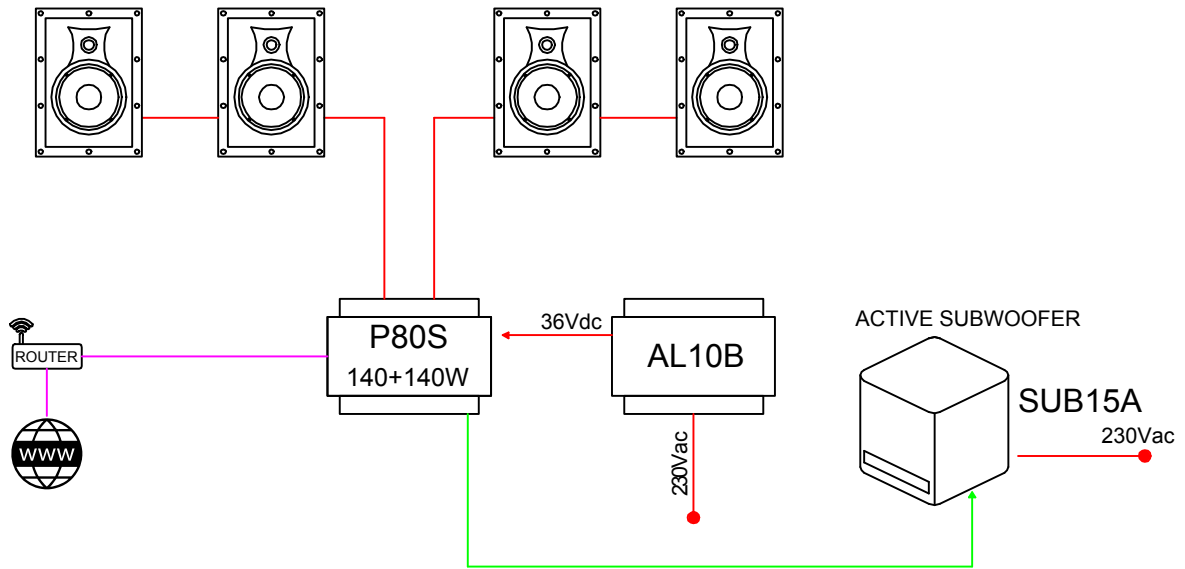

#### CABLE LEGEND

- CAVO DI ALIMENTAZIONE POLARIZZATO 2x1mm  
POLARIZED CABLE FOR POWER SUPPLY 2x1mm
- CAVO MICRO2  
MICRO2 CABLE
- CAVO CAT6  
CAT6 CABLE



APP (IOS & ANDROID)  
 gestione e controllo WiFi  
 WiFi management and control



## P80S MULTIMEDIA AMPLIFIER

SALA MEETING CON AUDIO STREAMING ED INGRESSI PER MICROFONI, RADIOMICROFONO E PC  
 MEETING ROOM WITH AUDIO STREAMING AND INPUT FOR MICROPHONE, WIRELESS MICROPHONE AND PC

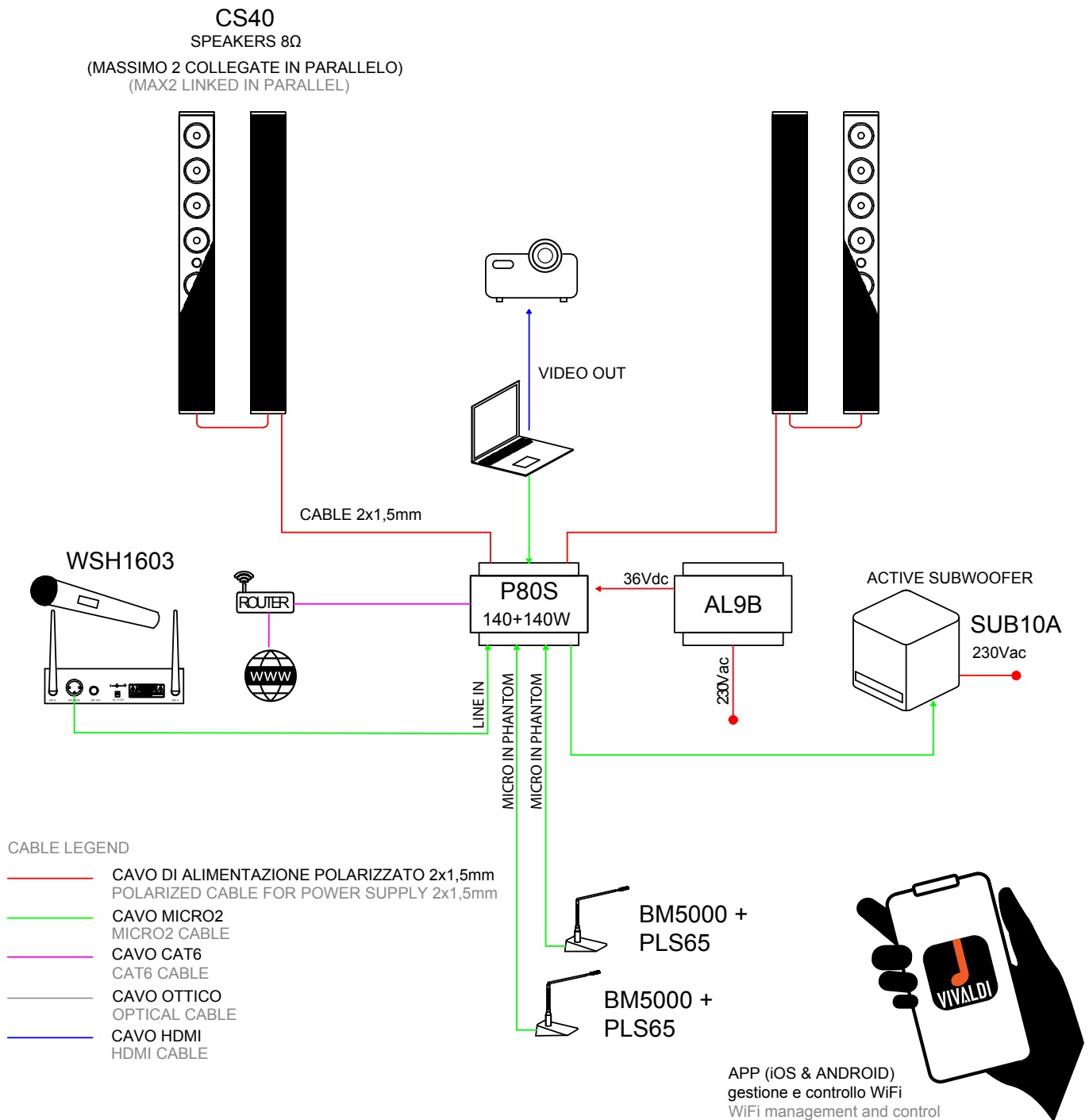

## P80S MULTIMEDIA AMPLIFIER

PALESTRA CON STREAMING ED INGRESSO PER RADIOMICROFONO  
 GYM WITH STREAMING AND INPUT FOR WIRELESS MICROPHONE

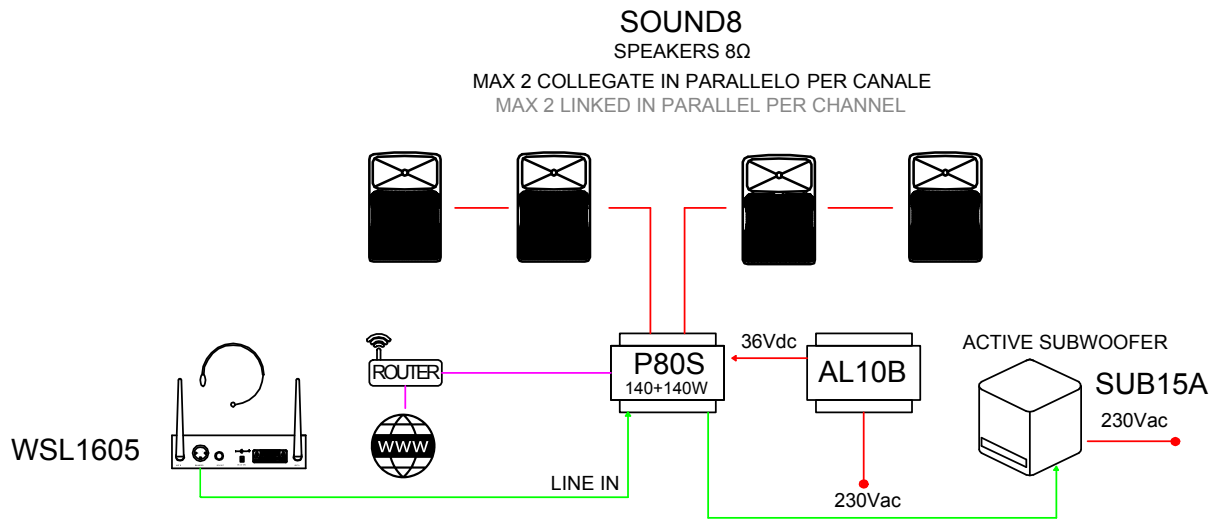

### CABLE LEGEND

- CAVO DI ALIMENTAZIONE POLARIZZATO 2x1,5mm  
POLARIZED CABLE FOR POWER SUPPLY 2x1,5mm
- CAVO MICRO2  
MICRO2 CABLE
- CAVO CAT6  
CAT6 CABLE



APP (iOS & ANDROID)  
 gestione e controllo WiFi  
 WiFi management and control

## P80S MULTIMEDIA AMPLIFIER

BAR GELATERIA CON REGOLAZIONE VOLUMI INDIPENDENTI SU DUE ZONE  
ICE CREAM BAR WITH INDEPENDENT VOLUME CONTROL ON TWO ZONES

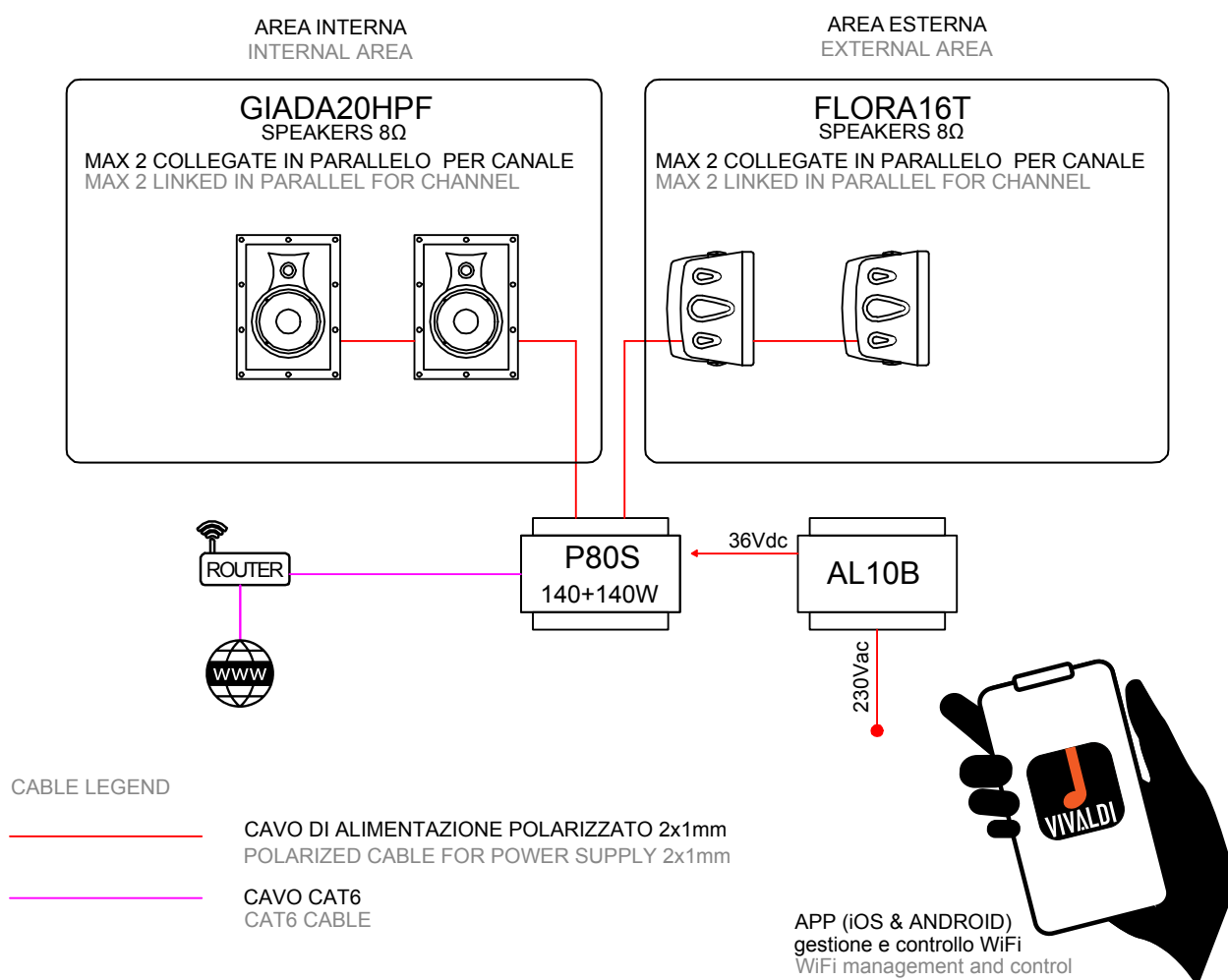



## P80S MULTIMEDIA AMPLIFIER

ABITAZIONE CON STREAMING E SISTEMA 2.1 SURROUND  
LIVINGROOM WITH STREAMING AND 2.1 SURROUND SYSTEM

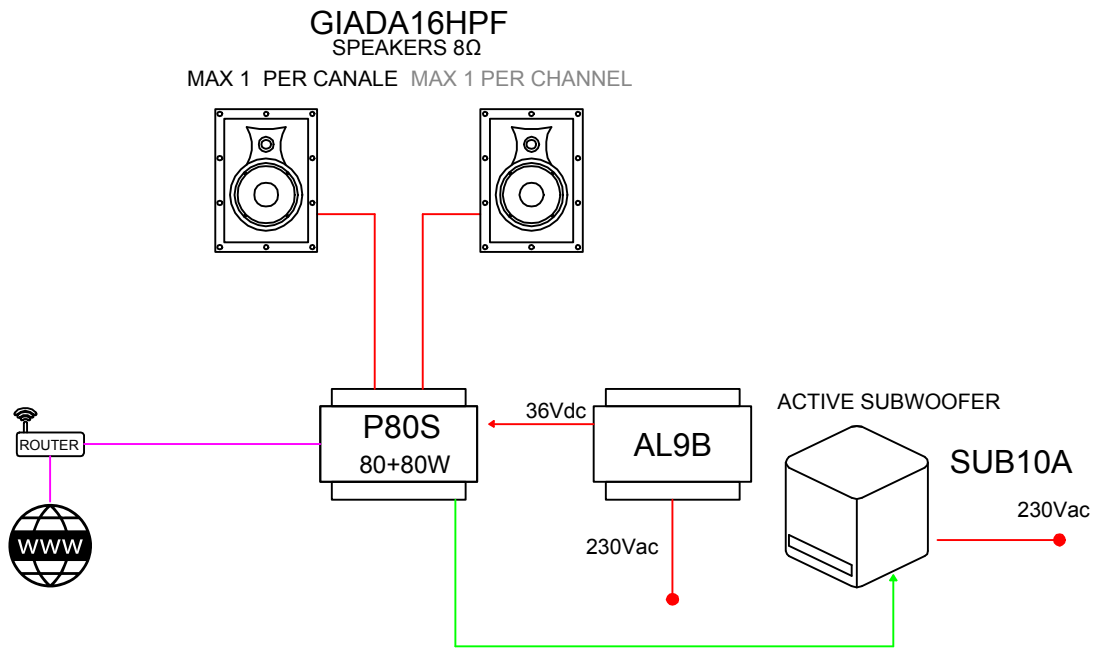

### CABLE LEGEND

- CAVO DI ALIMENTAZIONE POLARIZZATO 2x1mm  
POLARIZED CABLE FOR POWER SUPPLY 2x1mm
- CAVO MICRO2  
MICRO2 CABLE
- CAVO CAT6  
CAT6 CABLE



APP (iOS & ANDROID)  
gestione e controllo WiFi  
WiFi management and control

## P30S + P80S MULTIMEDIA AMPLIFIERS

ABITAZIONE CON STREAMING SU 3 ZONE (ESPANDIBILI), INDIPENDENTI O SINCRONIZZATE  
HOUSE WITH STREAMING ON 3 ZONES (EXPANDIBLE), INDIPENDENTS OR SINCRONIZED

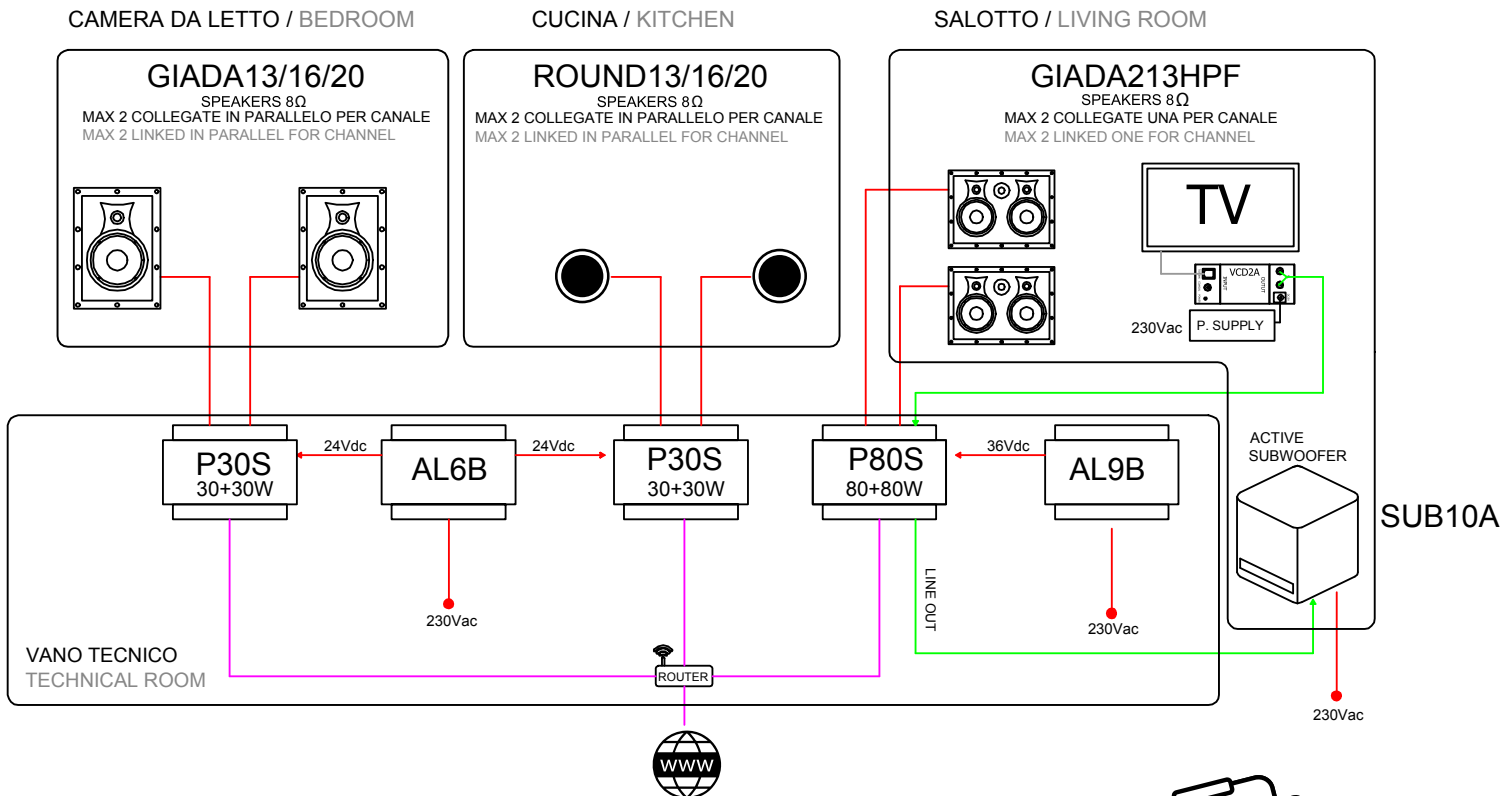

### CABLE LEGEND

- CAVO DI ALIMENTAZIONE POLARIZZATO 2x1mm  
POLARIZED CABLE FOR POWER SUPPLY 2x1mm
- CAVO MICRO2  
MICRO2 CABLE
- CAVO CAT6  
CAT6 CABLE
- CAVO OTTICO  
OPTICAL CABLE



APP (iOS & ANDROID)  
gestione e controllo WiFi  
WiFi management and control

# MATRIX6

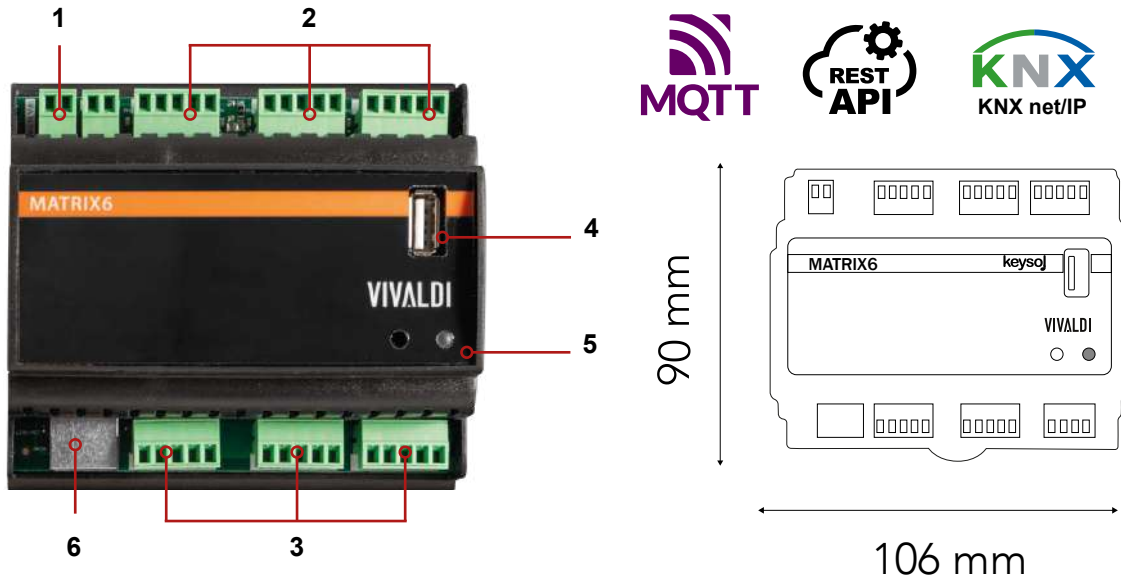

**1**  
Alimentazione 24VDC  
Power supply 24VDC2

**2**  
6 Ingressi audio bilanciato MONO  
6 MONO balanced audio inputs

**3**  
6 Uscite audio bilanciato MONO  
6 MONO Balanced Audio Outputs

**4**  
Porta USB per Upg FW e  
riproduzione file  
USB port for Upg FW and file  
playback

**5**  
Pulsante multifunzione e led  
di stato 1 6 Porta RJ45 per  
connessione alla rete LAN  
Multifunction button and status led  
1 6 RJ45 port for LAN connection

## ALIMENTAZIONE power supply

AL2B

## ACCESSORI accessories

E30S, E80S, A25SBTC  
PMA2120, PMA2240, PMA2005  
PSA300MK2, PSA500MK2  
PS1000, PS3000  
PSA4500, PSA6500, PSA8500

## CAMPI APPLICATIVI application fields



## MATRIX6

Matrice a 6 ingressi + 1 sorgente, domotica, con player multimediale integrato. APP di supervisione e controllo VIVALDI (scaricabile da iOS & Android).

**API disponibili:**

-KNXnet-IP (KNX IP Router necessario non di nostra fornitura)

-Protocollo MQTT 3.1 (tramite Broker esterno oppure integrato)

-REST-API (HTTP GET/POST)

6x INGRESSI MIC/LINE selezionabili con Phantom attivabile (24Vdc), priorità assegnabile (attivabile con contatto).

USB type A su frontale per riproduzione file audio MP3/WMA/AAC/AAC+/ALAC/FLAC/APE/WAV.

Equalizzatore a 3 bande. Uscite per espansioni di potenza E30S, E80S o finali di potenza Linea Vivaldi Ulisse a 8Ω o 100V. 1x RJ45 per rete LAN. 1x cavo PATCH da 1mt.

Controllo parametri audio con gestione volumi/settaggi/... da webpage. Integrabile a domotiche terze o ai dispositivi domotici multiprotocollo iCONTROL4.1L, iCONTROL4.0+ tramite rete LAN. Alimentazione 24Vdc tramite AL2B (non in dotazione). Standard DIN (6 moduli). Dimensioni (LxHxP): 106x90x63 mm. Peso 0.2 Kg.

Multimedia stereo device with DSP and multimedia player embedded. Matrix 6 inputs + 1 source. VIVALDI supervision and control APP (downloadable from iOS & Android).

**API available:**

-KNXnet-IP (KNX IP mandatory Router is not provided)

-Protocollo MQTT 3.1 (through external Broker or integrated)

-REST-API (HTTP GET/POST)

6x SELECTABLE MIC/LINE INPUTS with activable Phantom (24Vdc), assignable priority (can be activated with contact).

USB Type A on the front for MP3/WMA/AAC/AAC+/ALAC/FLAC/APE/WAV audio file playback.

3-band equalizer. Outputs for power expansions E30S, E80S or power amps Vivaldi Ulisse Line at 8Ω or 100V.

1x RJ45 per LAN. 1x PATCH cable 1mt. Audio parameter control with volume/settings/... from webpage.

Can be integrated with home automation systems iCONTROL4.1L, iCONTROL4.0+ via LAN. Power Supply 24Vdc via AL2B (not included). DIN standard (6 modules). Dimensions (WxHxD): 106x90x63 mm. Weight 0.2 Kg.

### MATRIX6 + E30S + PMA2120 MULTIMEDIA WiFi SYSTEM

RISTORANTE CON MATRICE AUDIO A CONTROLLO WiFi, 6 IN MIC/LINE, 6 OUT

RESTAURANT WITH MATRIX TO WiFi CONTROL, 6 MIC/LINE, 6 OUT

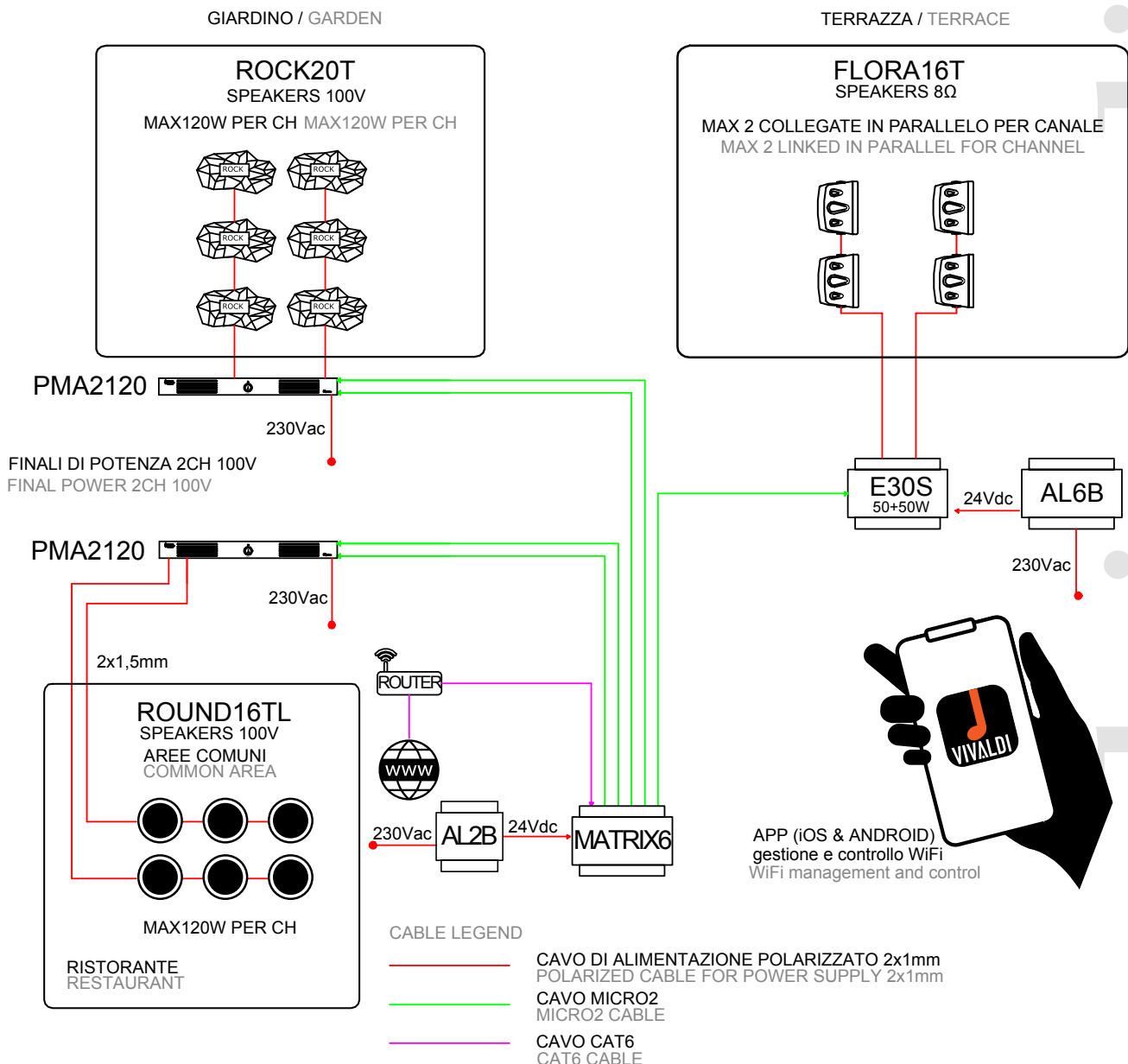



# E30S

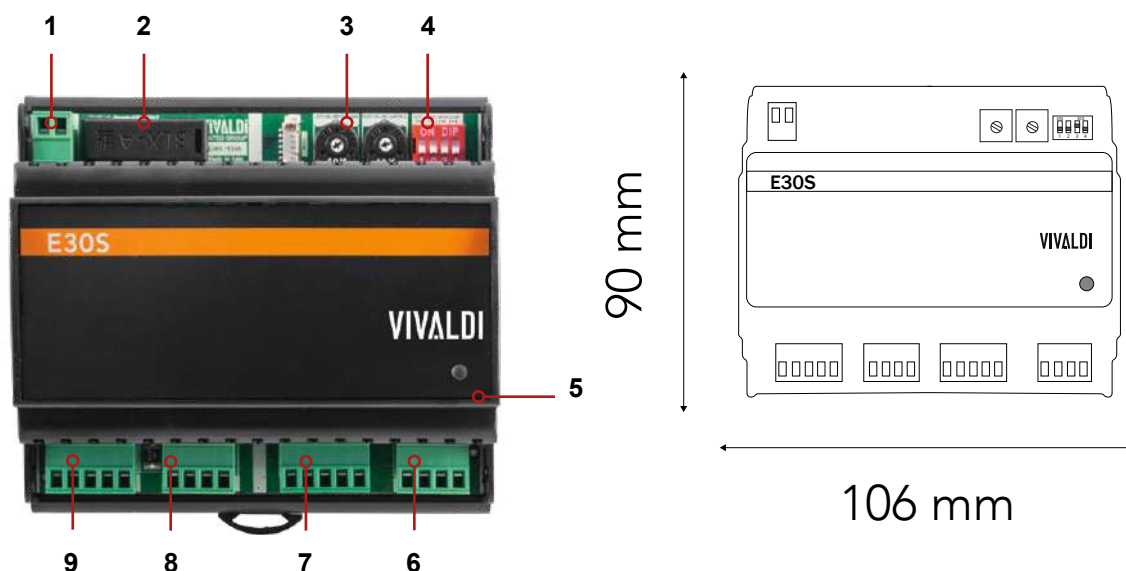

- |                                                                                                                                                                                                                |                                                                                                                                                                                        |                                                                                                                                                                                                                                                                 |
|----------------------------------------------------------------------------------------------------------------------------------------------------------------------------------------------------------------|----------------------------------------------------------------------------------------------------------------------------------------------------------------------------------------|-----------------------------------------------------------------------------------------------------------------------------------------------------------------------------------------------------------------------------------------------------------------|
| <p><b>1</b><br/>Alimentazione 24 VDC<br/>Power supply 24 VDC</p> <p><b>2</b><br/>Fusibile di protezione<br/>Protective fuse</p> <p><b>3</b><br/>Trimmer di regolazione locale<br/>Local adjustment trimmer</p> | <p><b>4</b><br/>DPI Switch di setup<br/>DPI Setup Switch</p> <p><b>5</b><br/>Led di stato<br/>Status LED</p> <p><b>6</b><br/>Uscita amplificata stereo<br/>Stereo amplified output</p> | <p><b>7</b><br/>Uscita Preout Stereo bilanciata<br/>Balanced Stereo Preout Output</p> <p><b>8</b><br/>Ingressi per potenza di controllo volume<br/>Inputs for volume control power</p> <p><b>9</b><br/>Ingresso stereo bilanciato<br/>Balanced stereo input</p> |
|----------------------------------------------------------------------------------------------------------------------------------------------------------------------------------------------------------------|----------------------------------------------------------------------------------------------------------------------------------------------------------------------------------------|-----------------------------------------------------------------------------------------------------------------------------------------------------------------------------------------------------------------------------------------------------------------|

## ALIMENTAZIONE power supply

- AL5B (24V 4,16A)
- AL6B (24V 6,25A)
- AL7B (24V 10A)

### E30S

**Amplificatore stereo con DSP.  
Potenza amplificatore classe-D 30+30W @ 8Ω, 50+50W @ 4Ω. Ingresso stereo bilanciato.**

Uscita amplificata configurabile come segue:

- Stereo lineare con regolazione volume per singolo canale, interna con Trimmer o esterna con Potenziometri (mono TVM, stereo TVS);

- Modalità Subwoofer con regolazione frequenza di taglio e volume da Trimmer.

Uscita di linea stereo bilanciata per connessione subwoofer attivo o amplificatore ausiliario E30S, E80S;

Possibilità di selezionarne il volume master o fisso.

Il dispositivo può essere impostato in modalità stereo o mono dal Dip Switch a bordo. Alimentazione 24Vdc tramite AL5B (non in dotazione). Standard DIN (6 moduli).

Dimensioni (LxHxP): 106x90x63 mm. Peso 0.14 Kg.

**DSP stereo amplifier. D - class power ampli 30+30W @ 8Ω, 50+50 @ 4Ω.**

Balance stereo input.

Amplifier output customisable as below:

- Linear stereo with volume adjustment for single channel, internal with trimmer or external with potentiometers (mono TVM, stereo TVS);

- Subwoofer mode with cut frequency adjustment and trimmer volume.

- Balance stereo line output for active subwoofer connection or auxiliary amp E30S, E80S;

- Possibility to select if linked to the master volume or fixed.

- The device can be set in stereo or mono mode by the dip switch on board.

Power supply 24Vdc via Vivaldi Giove AL5B (not included)

Standard DIN (6 modules) Size (WxHxD): 106x90x63 mm

Weight 0.14 kg.



### TVM\*

Coppia potenziometri mono con connessioni a morsetto montati su tappo copriforo.

Pair of mono potentiometers with clamp mounted on a hole cap.



### TVS\*

Potenziometro stereo con connessioni a morsetto montato su tappo copriforo.

Stereo potentiometer with solder clamp mounted on a hole cap.

\* Indicare al momento dell'ordine serie civile e colore desiderati. Cavo da utilizzare MICRO2 o MICRO4  
 \* Please, indicate when ordering the desired civil series adapter and colour. Important: use cable MICRO2 or MICRO4



### AL5B

Alimentatore da barra DIN (7,5 moduli). Input 100-240 Vac 50Hz 1,2A. Output 24 Vdc 4,16A, 100W. Colore nero. Dimensioni 138x88x65 mm (LxHxP). Peso 0,33 Kg.

DIN rail power supply (7,5 modules)  
 Input 100-240 Vac 50Hz 1,2A  
 Output 24 Vdc, 4,16A, 100W. Size: 138x88x65 mm (WxHxD). Weight 0,33 Kg.



### AL6B

Alimentatore da barra DIN (5,5 moduli). Input 100-240 Vac 50Hz 1,8A. Output 24 Vdc 6,25A, 150W. Colore nero. Dimensioni 103x58x90 mm (LxHxP). Peso 0,35 Kg.

DIN rail power supply (5.5 modules). Input 100-240 Vac 50Hz 1,8A. Output 24 Vdc 6,25A, 150W. Black colour. Size 103x58x90 mm (WxHxD). Weight 0,35 Kg.



### AL7B



Alimentatore da barra DIN. Input 100-240 Vac 50/60Hz 2,6A. Output 24 Vdc 10A, 240W. Dimensioni 65x126x110 mm (LxHxP). Peso 1,1 Kg. Colore nero.

DIN rail power supply. Input 100-240 Vac 50/60Hz 2,6A. Output 24 Vdc 10A, 240W. Size 65x126x110 mm (WxHxD). Weight 1,1 Kg. Black

# E80S

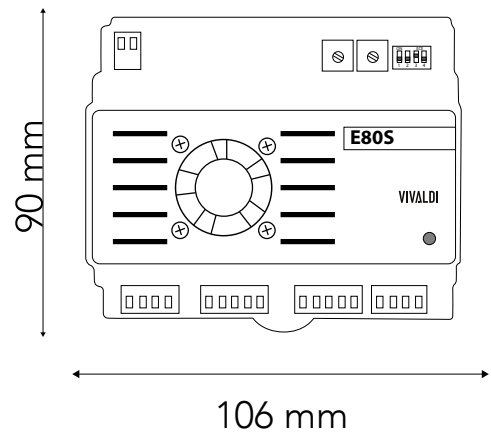
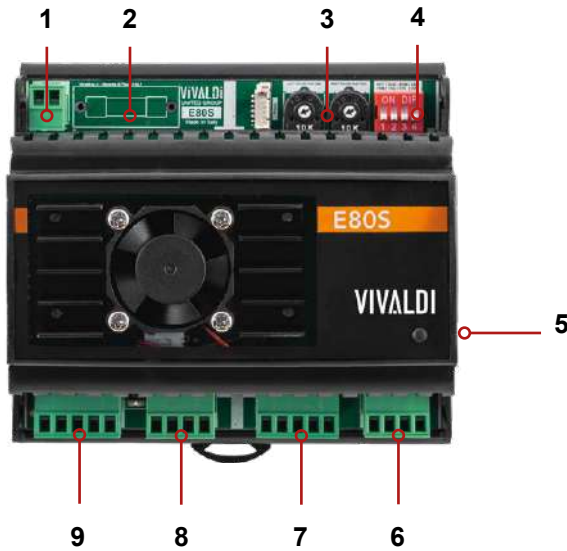

- 1**  
Alimentazione 24 VDC  
Power supply 24 VDC
- 2**  
Fusibile di protezione  
Protective fuse
- 3**  
Trimmer di regolazione locale  
Local adjustment trimmer

- 4**  
DPI Switch di setup  
DPI Setup Switch
- 5**  
Led di stato  
Status LED
- 6**  
Uscita amplificata stereo  
Stereo amplified output

- 7**  
Uscita Preout Stereo bilanciata  
Balanced Stereo Preout Output
- 8**  
Ingressi per potenza di controllo volume  
Inputs for volume control power
- 9**  
Ingresso stereo bilanciato  
Balanced stereo input

## ALIMENTAZIONE power supply

- AL9B (36 Vdc 4,2A, 150W)
- AL10B (36 Vdc 6,6A, 240W)
- AL203 (36 Vdc 9,7A)

## E80S

Amplificatore stereo con DSP. Potenza amplificatore classe-D 80+80W @ 8Ω, 140+140W @ 4Ω.

Ingresso stereo bilanciato.

Uscita amplificata configurabile come segue:

- Stereo lineare con regolazione volume per singolo canale, interna con Trimmer o esterna con Potenziometri (mono TVM, stereo TVS);

- Modalità Subwoofer con regolazione frequenza di taglio e volume da Trimmer.

Uscita di linea stereo bilanciata per connessione subwoofer attivo o amplificatore ausiliario E30S, E80S;

Possibilità di selezionarne il volume master o fisso.

Il dispositivo può essere impostato in modalità stereo o mono dal Dip Switch a bordo. Alimentazione 36Vdc tramite AL9B (non in dotazione). Standard DIN (6 moduli).

Dimensioni (LxHxP): 106x90x63 mm. Peso 0.14 Kg.



DSP stereo amplifier. Class - D power amp. 80+80W @ 8Ω, 140+140 @ 4Ω. Balanced stereo input.

Amplifier output customisable as below:

- Linear stereo with volume adjustment for single channel, internal with trimmer or external with potentiometers (mono TVM, stereo TVS);

- Subwoofer mode with cut frequency adjustment and trimmer volume.

- Balance stereo line output for active subwoofer connection or auxiliary amp E30S, E80S;

- Possibility to select if linked to the master volume or fixed.

- The device can be set in stereo or mono mode by the dip switch on board.

Power supply 36Vdc via AL9B (not included)

Standard DIN (6 modules)

Size (WxHxD): 106x90x63 mm. Weight 0.14 kg.

## AL9B

Alimentatore da barra DIN (6 moduli)

Input 100-240 Vac 50Hz 1,8A

Output 36 Vdc 4,2A, 150W

Colore nero

Dimensioni 103x58x90 mm (LxHxP)

Peso 0,35 Kg



DIN rail power supply (6 modules)

Input 100-240 Vac 50Hz 1,8A

Output 36 Vdc 4,2A, 150W

Black colour

Size: 103x58x90 mm (WxHxD)

Weight 0,35 Kg

## AL10B NEW

Alimentatore da barra DIN

Input 100-240 Vac 50Hz 1,2A

Output 36 Vdc 6,6A, 240W

Colore nero

Dimensioni 65x126x110 mm (LxHxP) Peso 1,1 Kg



DIN rail power supply

Input 100-240 Vac 50Hz 1,2A

Output 36 Vdc 6.6A, 240W

Black

Size: 65x126x110 mm (WxHxD) Weight 1,1 Kg

## AL203

Alimentatore ventilato.

Input 180-264 Vac 50-60Hz 9,7A, 350W.

Output 36 Vdc 9,7A.

Dimensioni 215x115x50 mm (LxHxP).

Peso 1 Kg.

Power supply with fan.

Input: 180-264 Vac 50-60Hz 9,7A, 350W.

Output: 36 Vdc 9,7A.

Size: 215x115x50 mm (WxHxD)

Weight 1 Kg.



**MATRIX6 + E30S MULTIMEDIA AMPLIFIERS AND MATRIX**  
 SALA CONFERENZE CON CONTROLLO, 6 IN MIC/LINE, 6 OUT  
 CONFERENCE ROOM WITH MATRIX TO CONTROL, 6 IN MIC/LINE, 6 OUT

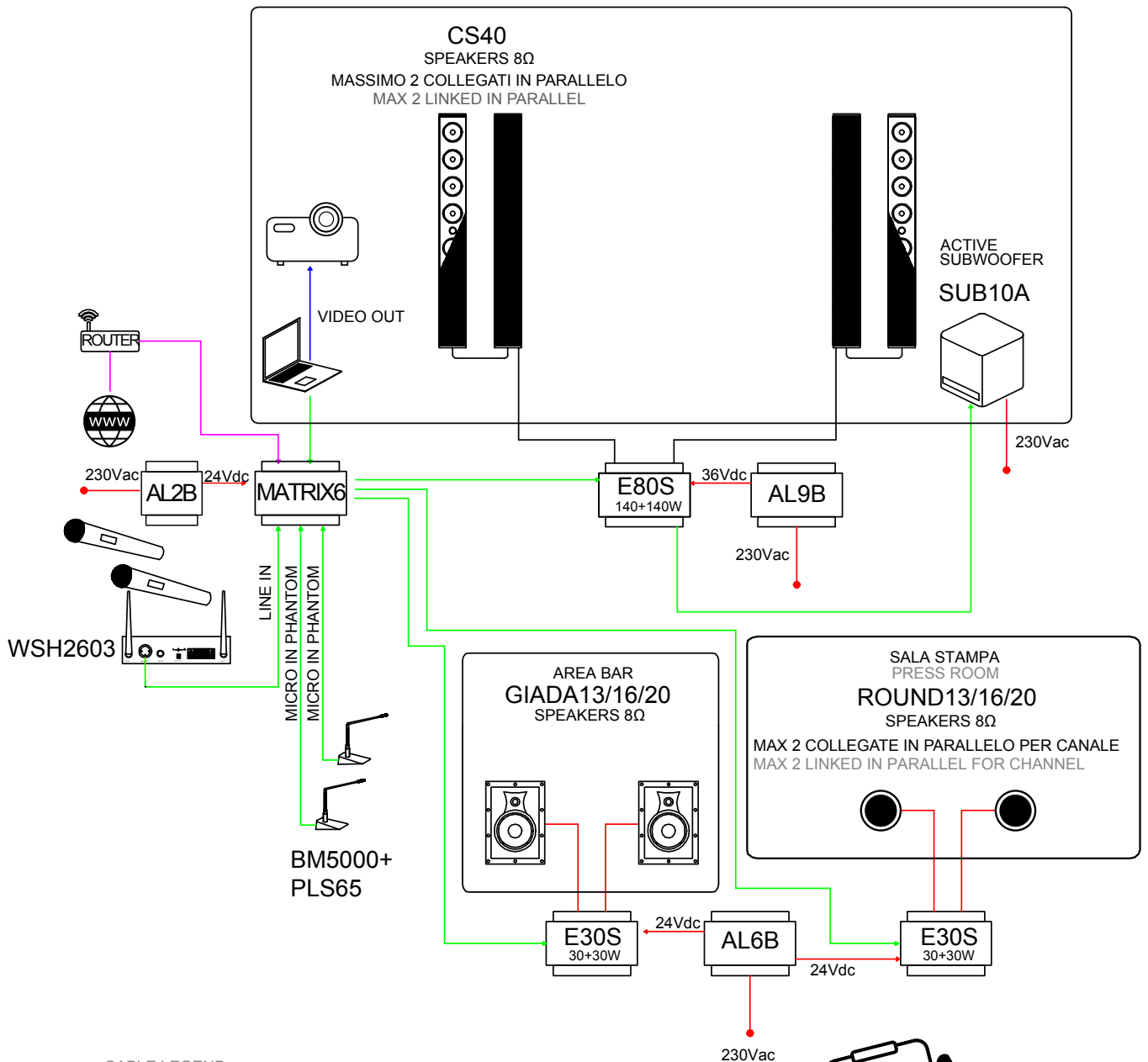

CABLE LEGEND

- CAVO DI ALIMENTAZIONE POLARIZZATO 2x1mm  
POLARIZED CABLE FOR POWER SUPPLY 2x1mm
- CAVO MICRO2  
MICRO2 CABLE
- CAVO CAT6  
CAT6 CABLE
- CAVO OTTICO  
OPTICAL CABLE
- CAVO HDMI  
HDMI CABLE

APP (iOS & ANDROID)  
 gestione e controllo WiFi  
 WiFi management and control



## MATRIX6 + E30 MULTIMEDIA AMPLIFIERS AND MATRIX SISTEMA CONGRESSUALE CON MATRICE MULTIMEDIALE PER CONTROLLO ZONE CONFERENCE SYSTEM WITH MULTIMEDIA MATRIX FOR ZONES CONTROL

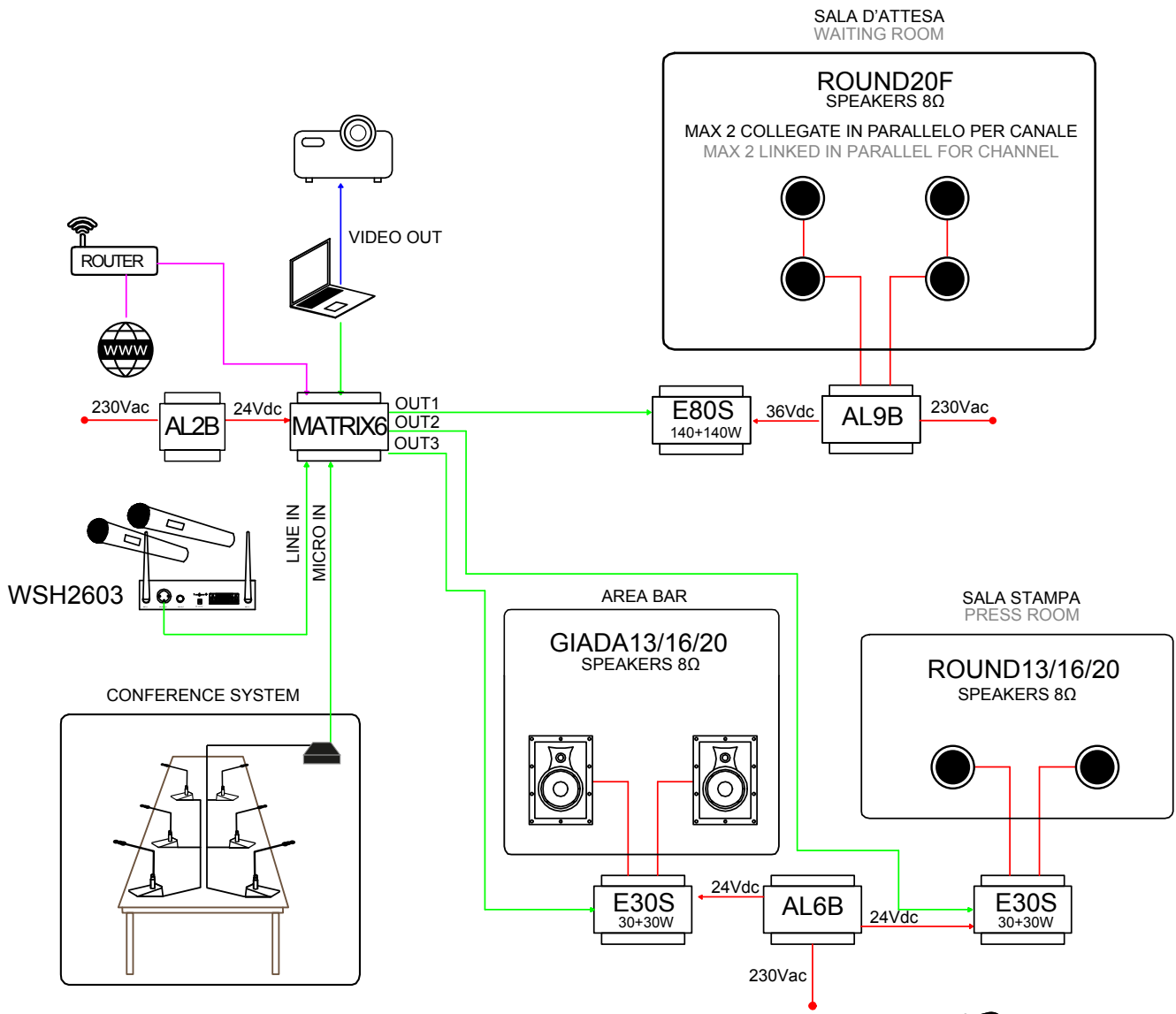

### CABLE LEGEND

- CAVO DI ALIMENTAZIONE POLARIZZATO 2x1mm  
POLARIZED CABLE FOR POWER SUPPLY 2x1mm
- CAVO MICRO2  
MICRO2 CABLE
- CAVO CAT6  
CAT6 CABLE
- CAVO OTTICO  
OPTICAL CABLE
- CAVO HDMI  
HDMI CABLE



APP (iOS & ANDROID)  
gestione e controllo WiFi  
WiFi management and control

## MATRIX6 + E30S + E80S MULTIMEDIA MATRIX AND AMPLIFIERS

CENTRO SPORTIVO CON STREAMING WiFi CON CONTROLLO, 6 IN MIC/LINE, 6 OUT  
SPORT CENTER WITH STREAMING AND CONTROL, 6 IN MIC/LINE, 6 OUT

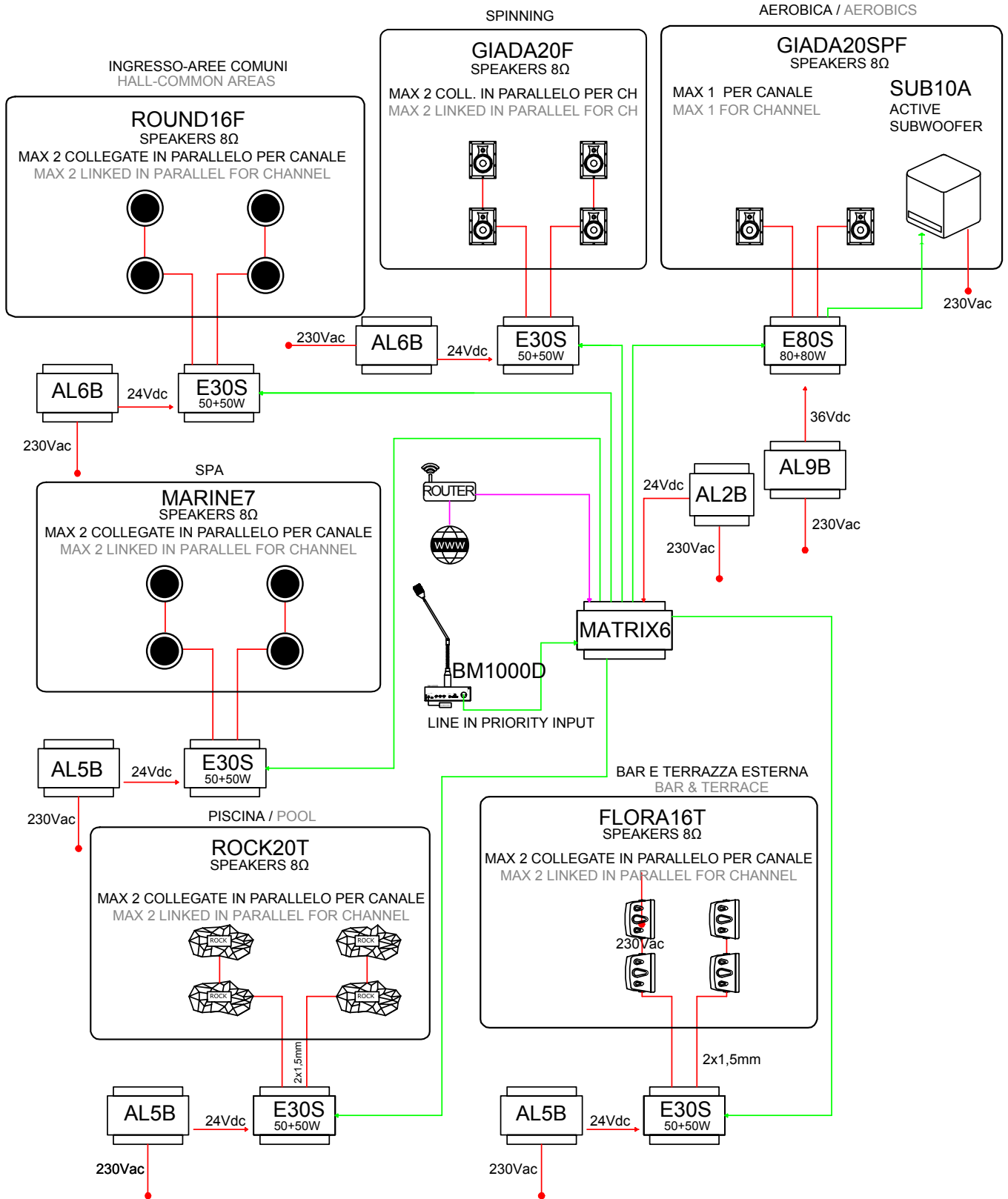

## MATRIX6 + E30S + A25SBTC MULTIMEDIA MATRIX AND AMPLIFIERS WiFi/BLUETOOTH

ABITAZIONE CON STREAMING CON CONTROLLO WiFi, 6 IN MIC/LINE, 6 OUT  
RESIDENCE WITH STREAMING AND WiFi CONTROL, 6 IN MIC/LINE, 6 OUT

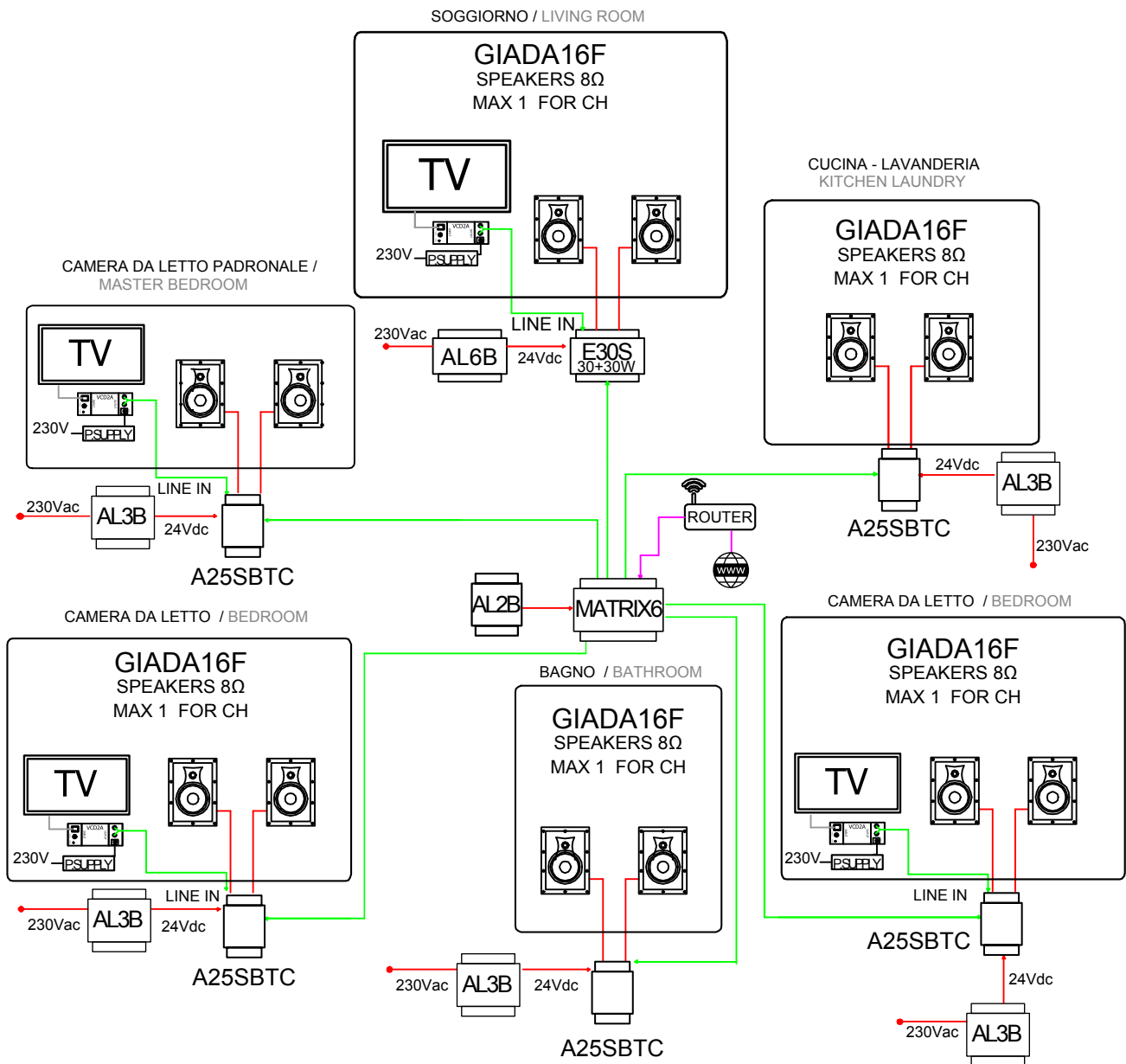

### CABLE LEGEND

- CAVO DI ALIMENTAZIONE POLARIZZATO 2x1mm  
POLARIZED CABLE FOR POWER SUPPLY 2x1mm
- CAVO MICRO4  
MICRO4 CABLE
- CAVO CAT6  
CAT6 CABLE
- CAVO OTTICO  
OPTICAL CABLE

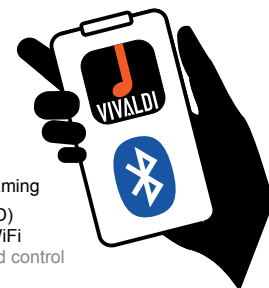

bluetooth & WiFi streaming  
APP (iOS & ANDROID)  
gestione e controllo WiFi  
WiFi management and control





# Musica Bluetooth

per strutture ricettive

Porta la tua musica in vacanza

**Bluetooth music for Hospitality**

*Take your music on holiday*

# A25SBTC

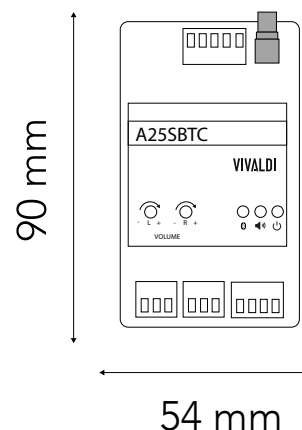
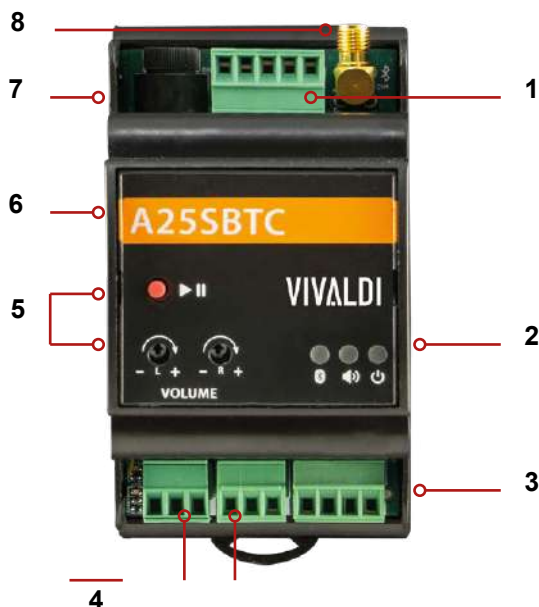

- |                                                                                                                                                                                                    |                                                                                                                                                                                                                                   |                                                                                                                                                    |
|----------------------------------------------------------------------------------------------------------------------------------------------------------------------------------------------------|-----------------------------------------------------------------------------------------------------------------------------------------------------------------------------------------------------------------------------------|----------------------------------------------------------------------------------------------------------------------------------------------------|
| <p><b>1</b><br/>Alimentazione e ingresso audio<br/>Power supply and audio input</p> <p><b>2</b><br/>Led di stato<br/>Status LED</p> <p><b>3</b><br/>Connessione speaker<br/>Speaker connection</p> | <p><b>4</b><br/>Regolazione volume esterna<br/>External volume adjustment</p> <p><b>5</b><br/>Play/pausa e regolazione volume<br/>Play/pause and volume adjustment</p> <p><b>6</b><br/>Din box 3 moduli<br/>Din box 3 modules</p> | <p><b>7</b><br/>Fusibile di protezione<br/>Protective fuse</p> <p><b>8</b><br/>Connettore antenna BT esterna<br/>External BT antenna connector</p> |
|----------------------------------------------------------------------------------------------------------------------------------------------------------------------------------------------------|-----------------------------------------------------------------------------------------------------------------------------------------------------------------------------------------------------------------------------------|----------------------------------------------------------------------------------------------------------------------------------------------------|

## ALIMENTAZIONE power supply

AL3B

## A25SBTC

**Amplificatore di potenza 25+25W RMS, stereo, con ingresso audio analogico e sorgente Bluetooth integrata.** Fornito con PIN standard o personalizzato (codice PIN programmato in fabbrica: nome max 30 caratteri, password max 4 numeri) da comunicare in fase d'ordine. **Funzione mono/stereo selezionabile da DIP switch.** Selezione modalità controllo volume da DIP switch. Volume interno (trimmer) o potenziometri esterni (mono TVM, stereo TVS). **La sorgente bluetooth integrata ha priorità sul segnale proveniente dall'ingresso.** Regolazione sensibilità rilevatore audio integrato. LED DI STATO: blu: bluetooth attivo verde: presenza di segnale musicale rosso: accensione. PULSANTI: play, pausa. DATI TECNICI: 1x morsetto Ingresso audio locale (stereo) e alimentazione 24Vdc.

## CAMPI APPLICATIVI application fields



**25+25W RMS power stereo amplifier, with analog audio input and integrated Bluetooth source.** Included with standard or custom PIN (PIN code programmed factory: name max 30 characters, password max 4 numbers) to be communicated when ordering. **Mono/stereo function selectable from DIP switch.** Select volume control mode from DIP switch. Internal volume (trimmer) or external potentiometers (mono TVM, stereo TVS). **The built-in bluetooth source takes priority over the signal coming from the input.** Built-in audio detector sensitivity adjustment. STATUS LED: blue: Bluetooth Active, green: presence of music signal, red: Power. BUTTONS: play, pause. TECHNICAL DATA: 1x Clamp Local audio input (stereo) and 24Vdc power supply. 1x speaker connection terminal 25W @ 4-8 Ω



1x morsetto connessione speaker 25W @ 4-8Ω per canale (impedenza minima 4Ω/canale).  
 2x morsetti connessione potenziometro remoto esterno.  
 1x connettore SMA per antenna bluetooth esterne (se installato non in stanza, ma in un vano tecnico).  
 Controllo di sensibilità ingresso a seconda del tipo di sorgente esterna. Alimentazione tramite AL3B (da ordinare a parte). Corrente 1,2A. Dimensioni 54x90x63 (3 Moduli) mm (LxHxP). Peso 0.10 Kg.

per channel (minimum impedance 4Ω/channel).  
 2x terminals connection external remote potentiometer.  
 1x SMA connector for external bluetooth antenna and(if installed not in the room, but in a technical room).  
 Input sensitivity control depending on the type of external source. Power supply via AL3B (not included).  
 Current 1,2A. Size: 54x90x63 (3 Modules) mm (WxHxD).  
 Weight 0.10 Kg.



### AL3B

Alimentatore da barra DIN (4,5 moduli). Input 100-240 Vac 50-60Hz 1,8A. Output 24 Vdc 2,5A. Colore nero. Dimensioni 80x100x60 mm (LxHxP). Peso 0,3 Kg. DIN rail power supply (4,5 modules) Input 100-240 Vac 50-60Hz 1,8A Output 24 Vdc 2,5A. Black Colour. Size: 80x100x60 mm (WxHxD). Weight 0,3 Kg.



### PBT

Prolunga antenna Bluetooth da usare oltre i 10mt di portata antenna interna all'A25SBTC. Bluetooth antenna extension to be used over 10mt A25SBTC internal antenna range.

### TVM

Coppia potenziometri mono con connessioni a morsetto montati su tappo copriforo. Pair of mono potentiometers with clamp mounted on a hole cap.

### TVS

Potenziometro stereo con connessioni a morsetto montato su tappo copriforo. Stereo potentiometer with clamp mounted on a hole cap.

## A25SBTC BLUETOOTH AMPLIFIER

CAMERA D'HOTEL CON AMPLIFICATORE BLUETOOTH ED INGRESSO PER SORGENTE LOCALE  
 HOSPITALITY ROOM WITH BLUETOOTH AMPLIFIER AND INPUT FOR LOCAL SOURCE

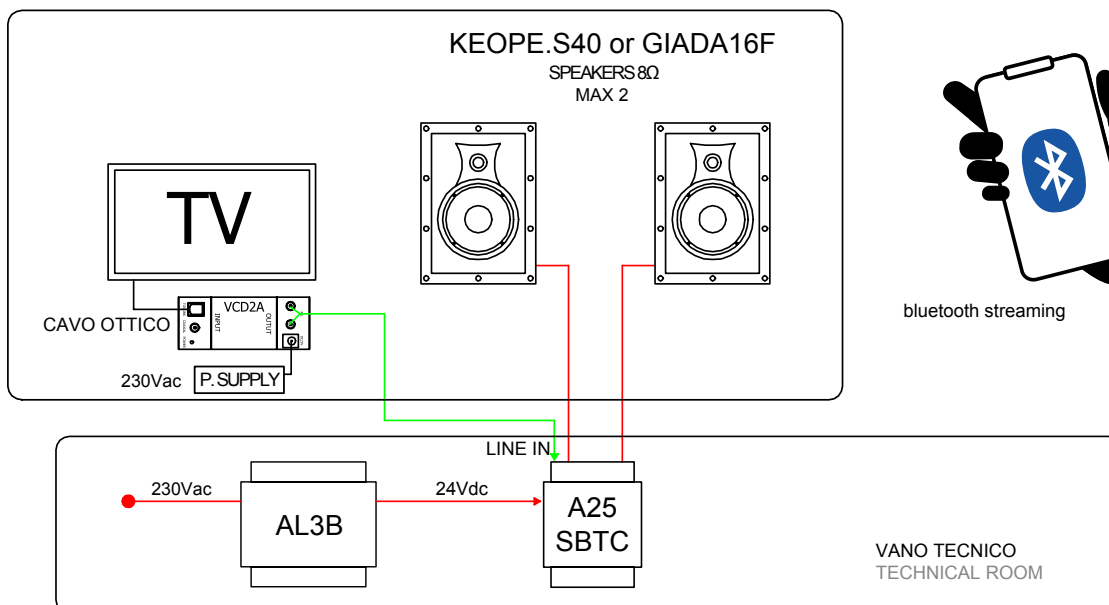

#### CABLE LEGEND





- CAVO DI ALIMENTAZIONE POLARIZZATO 2x1mm  
POLARIZED CABLE FOR POWER SUPPLY 2x1mm
- CAVO MICRO2  
MICRO2 CABLE



- GIADA506F** bianco / white
-  **GIADA506F.R** (min 10pz)
- GIADA506TF** bianco / white
-  **GIADA506TF.R** (min 10pz)
- RG506FB** retina black per GIADA506F/TF
- GIADA10F** bianco / white
-  **GIADA10F.R** (min 10pz)
- GIADA10TF** bianco / white
-  **GIADA10TF.R** (min 10pz)
- RG10FB** retina black per GIADA10F/TF
- SR10**



	<b>GIADA506F</b>	<b>GIADA506TF</b>	<b>GIADA10F</b>	<b>GIADA10TF</b>
Descrizione / Description	incasso <b>frameless</b> recessed <b>frameless</b>	incasso <b>frameless</b> recessed <b>frameless</b>	incasso <b>frameless</b> recessed <b>frameless</b>	incasso <b>frameless</b> recessed <b>frameless</b>
Woofers	7,5 cm	7,5 cm	11 cm	11 cm
Tweeter	---	---	1,3 cm mylar	1,3 cm mylar
Membrana / Diaphragm	polypropylen	polypropylen	---	---
Potenza RMS / musicale RMS / Music Power	30W / 60W	---	30W/60W	---
Potenza nominale / peak Nominal power / peak	---	8W / 16W max 93dB	---	1,5/3/6W 12W peak
Amplificazione consigliata Recommended amplification	da 10 a 40W RMS 10 to 40W RMS	---	da 10 a 40W RMS 10 to 40W RMS	---
Impedenza / Tensione trasformatore Impedance / Transformer voltage	8Ω	100V	8Ω	100V
Risposta in frequenza / Sensibility Frequency response / sensitivity	65-18000Hz/85dB	65-18000Hz/85dB	60-20000Hz/88dB	70-20000Hz-10dB/87dB max 1mt 94dB
Dimensioni (LxHxD) / Size (WxHxD)	125x125x48 mm	125x125x48 mm	147x222x60 mm	147x222x65 mm
Foro da incasso (LxH) / Recessed hole (WxH)	---	---	120x195 mm	120x195 mm
Incasso su cartongesso / Recessed on plasterboard	---	---	non servono accessori, il diffusore nel retro è dotato di ganci per l'ancoraggio stabile no accessories needed, the speaker is provided with hook shaped anchors for stable fixing in the rear	
Incasso / built-in box	506E	506E	SR10 (per muratura / on masonry pag. 146)	SR10 (per muratura / on masonry pag. 146)
Peso / Weight	0,35 kg	0,40 kg	0,9 kg	1,1 kg
Colori disponibili / Available colors	white RAL 9016	white RAL 9016	white RAL 9003	white RAL 9003
Cabinet	ABS V0 con griglia di protezione zincata verniciata ABS V0 with painted galvanized grille			

-  **ROUND7F**
-  **ROUND7F.R** (min 10pz)
- ROUND7TF**
-  **ROUND7TF.R** (min 10pz)
- RR7FB** retina black per ROUND7F/TF
- ROUND13F**
-  **ROUND13F.R** (min 10pz)
- ROUND13TF**
-  **ROUND13TF.R** (min 10pz)
- RR13FB** retina black per ROUND13F/TF
- RR13F** retina per ROUND13F/TF

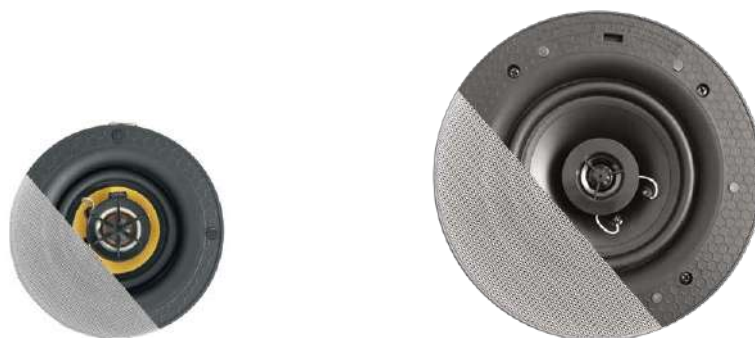

	<b>ROUND7F</b>	<b>ROUND7TF</b>	<b>ROUND13F</b>	<b>ROUND13TF</b>
Descrizione / Description	Diffusore rotondo 2 vie, da incasso, HiFi, <b>frameless</b> / Round speaker 2 way recessed, HiFi, <b>frameless</b>			
Woofers	7,5 cm kevlar	7,5 cm kevlar	13,5 cm	13,5 cm
Tweeter orientabile / adjustable	a cupola 1,3 cm dome 1.3 cm	a cupola 1,3 cm dome 1.3 cm	a cupola 1,3 cm dome 1.3 cm	a cupola 1,3 cm dome 1.3 cm
Magnete / Magnet	neodimio / neodymium	neodimio / neodymium	neodimio / neodymium	neodimio / neodymium
Membrana / Diaphragm	titanio / titanium	titanio / titanium	mylar	mylar
Potenza RMS / musicale RMS / Music Power	20W/40W	---	50W/100W	---
Potenza nominale / peak Nominal power / peak	---	3/6W 12W peak, max 101dB	---	2,5/5/10/15W 30W peak, max 102dB
Amplificazione consigliata Recommended amplification	da 10 a 30W RMS 10 to 30W RMS	---	da 10 a 110W RMS 10 to 110W RMS	---
Impedenza / Tensione trasformatore Impedance / Transformer voltage	8Ω	100V	8Ω	100V
Risposta in frequenza / Sensibilità Frequency Response / Sensitivity	130-20000Hz +3dB/90dB	130-20000Hz +3dB/90dB	70-20000Hz/87dB	70-20000Hz/87dB
Angolo di dispersione / Dispersion angle	120° (V/O)	120° (V/O)	120° (V/O)	120° (V/O)
Dimensioni (DxP) / Size (DxD)	116x58 mm	116x90 mm	204x77 mm	204x90 mm
Foro da incasso (D) / Recessed hole (D)	100 mm	100 mm	177 mm	177 mm
Peso / Weight	0,4 kg	0,8 kg	1,2 kg	1,3 kg
Colore / Color	bianco / white RAL9016	bianco / white RAL9016	bianco / white RAL9016	bianco / white RAL9016
Cabinet	ABS V0 con griglia di protezione zincata verniciata / ABS V0 with painted galvanized grille			
Incasso su muratura / Recessed on masonry	non adatto / not suitable	non adatto / not suitable	SR13 (pag.148)	SR13 (pag.148)
Incasso su cartongesso Recessed on plasterboard	non servono accessori, il diffusore nel retro è dotato di ganci per l'ancoraggio stabile no accessories needed, the speaker is provided with hook shaped anchors for stable fixing in the rear			

## A25SBTC + KEYSOL-DIN + TVM BLUETOOTH & WIFI

STREAMING AUDIO WiFi E BLUETOOTH SU 2 ZONE CON REGOLAZIONI VOLUMI INDIPENDENTI  
 BLUETOOTH AND WiFi AUDIO STREAMING ON 2 ZONES WITH INDEPENDENT VOLUME CONTROLS

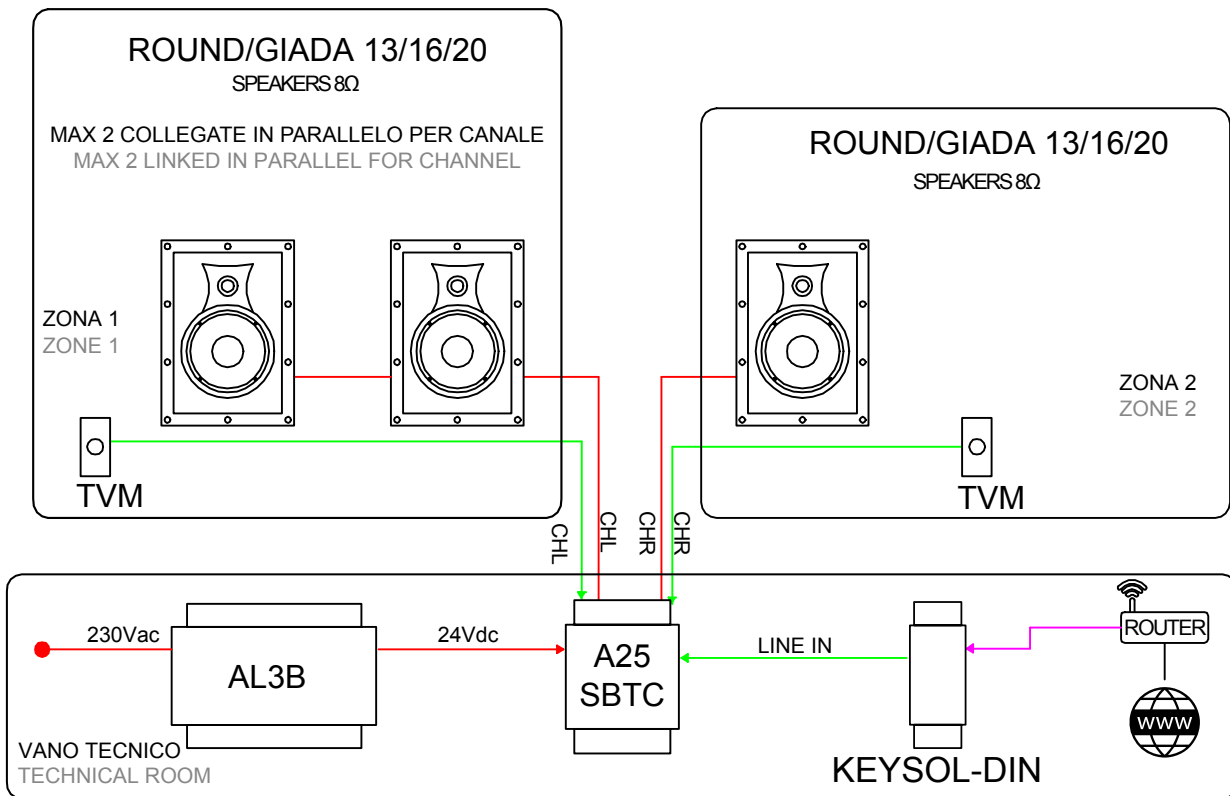

### CABLE LEGEND

- CAVO DI ALIMENTAZIONE POLARIZZATO 2x1mm  
POLARIZED CABLE FOR POWER SUPPLY 2x1mm
- CAVO MICRO2  
MICRO2 CABLE
- CAVO CAT6  
CABLE CAT6



bluetooth & WiFi streaming  
 APP (iOS & ANDROID)  
 gestione e controllo WiFi  
 WiFi management and control

## A25SBTC + PROLUNGA ANTENNA BLUETOOTH

CAMERA D'HOTEL CON ANTENNA BLUETOOTH ESTERNA (DELOCALIZZATA DISTANTE MAX 5MT DALL'AMPLIFICATORE)  
 HOSPITALITY ROOM WITH EXTERNAL BLUETOOTH RECEIVER (MAX 5MT FROM AMPLIFIER)

**ROUND/GIADA 13/16F**  
 MAX 2 COLLEGATE IN PARALLELO PER CANALE  
 MAX 2 LINKED IN PARALLEL FOR CHANNEL

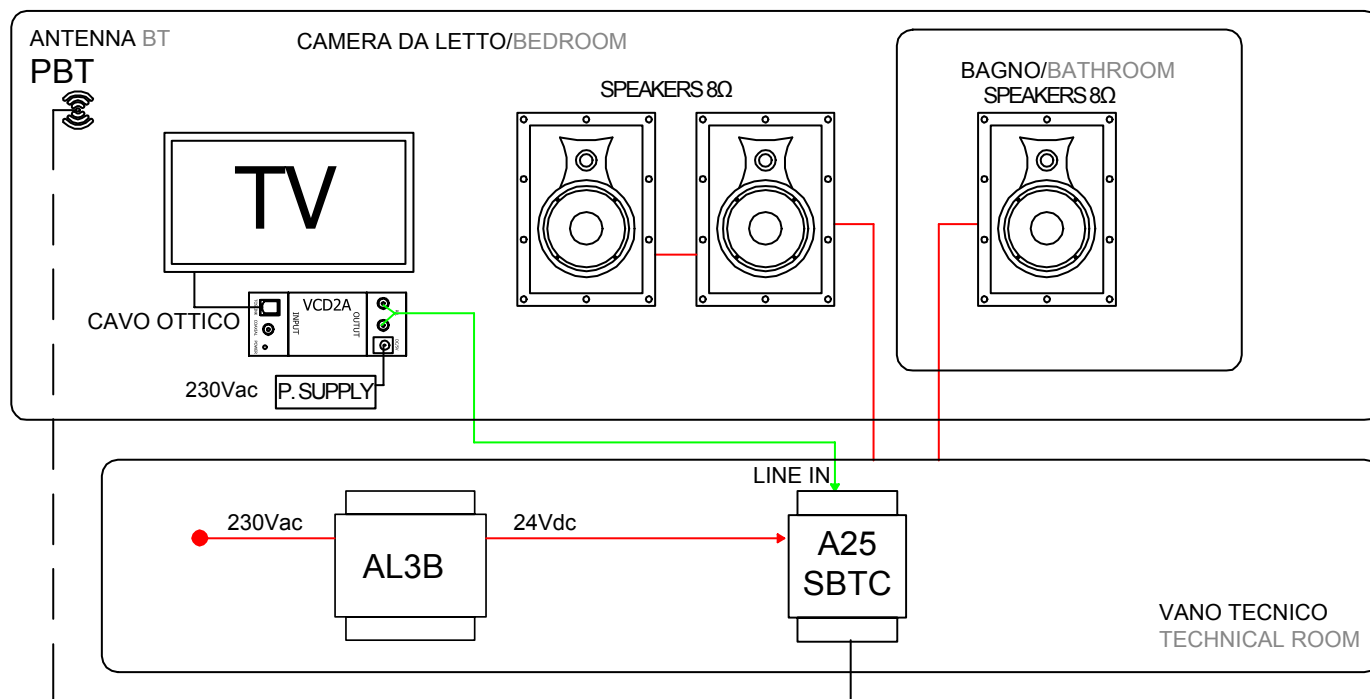

### CABLE LEGEND

- CAVO DI ALIMENTAZIONE POLARIZZATO 2x1mm  
POLARIZED CABLE FOR POWER SUPPLY 2x1mm
- CAVO MICRO2  
MICRO2 CABLE
- - - - - BLUETOOTH RECEIVER WITH CABLE





## A25SBTC + KEYSOL-DIN + TVS BLUETOOTH & WiFi

STREAMING AUDIO WiFi E BLUETOOTH SU 1 ZONA CON REGOLAZIONE VOLUME  
 BLUETOOTH AND WiFi AUDIO STREAMING ON 1 ZONE WITH VOLUME CONTROL

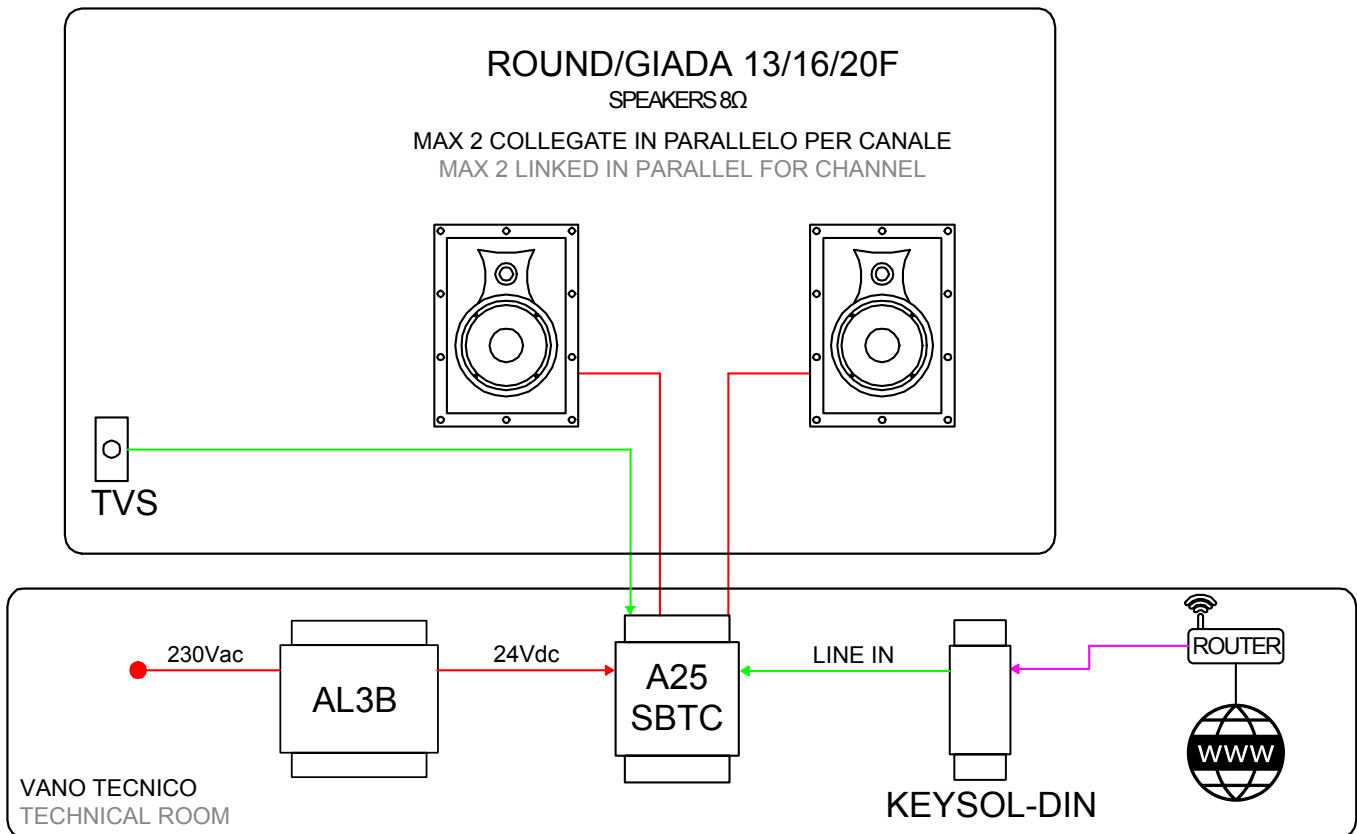

### CABLE LEGEND

- CAVO DI ALIMENTAZIONE POLARIZZATO 2x1mm  
POLARIZED CABLE FOR POWER SUPPLY 2x1mm
- CAVO MICRO2  
MICRO2 CABLE
- CAVO CAT6  
CABLE CAT6



bluetooth & WiFi streaming  
 APP (iOS & ANDROID)  
 gestione e controllo WiFi  
 WiFi management and control



# Talent



	KEYSOL-DIN	P40SL	P30S	P80S	MATRIX6	TELEMACO	A25SBTC	E30S	E80S
Player multisorgente multimediale	•	•	•	•	•	•			
Streaming	Webradio-NAS-Airplay-DLNA-Archivio locale-Spotify connect		Webradio-NAS-Airplay-DLNA- Archivio locale-Spotify connect-Youtube						
App	App Vivaldi (iOS/Android)					App Telemaco (iOS/Android/Windows/MacOs)			
Ingresso USB	•		•	•	•				
Formato Audio	MP3/WMA/AAC/AAC+/ALAC/FLAC/APE/WAV								
Bluetooth							Play / pausa e regolazione del volume sul dispositivo		
Ingresso RJ45	•	•	•	•	•	•			
Ingresso Audio	1 x stereo sbilanciato	1 x Stereo sbilanciato 1 x S/PDIF con connessione Toslink ed RCA	4 x Mono selezionabile Mic/linea con phantom attivabile, 1 x Stereo bilanciato o 3 x Stereo bilanciato		6 x Mono selezionabile Mic/linea con phantom attivabile	3 x Stereo sbilanciato	1 x stereo sbilanciato	2 x mono oppure 1 x stereo bilanciato	2 x mono oppure 1 x stereo bilanciato
Uscita linea audio	1 x stereo bilanciato				6 x Mono bilanciato				
Uscita mono per sub attivo			•	•					
Uscita amplificata per diffusori		•	•	•		•	•	•	•
Equalizzatore			7 bande		3 bande per uscita				
Controlli parametri audio	Da App Vivaldi		Da paginaWeb / App Vivaldi			App Telemaco	Hardware	Hardware	Hardware
Integrazione ai sistemi domotici	con API MQTT, KNX, REST								
Funzione stand-alone	•	•	•	•	•	•			
Funzione multiroom su gruppi zone	•	•	•	•	•	1 Telemaco (fino a 6 zone) 2 Telemaco (fino a 12 zone)			
Funzione multiroom in tutte le zone	•	•	•	•	•	•			
Sveglia con musica dalla rete	•	•							
DIP switch setup (Mono/Stereo - Selezione controllo volume esterno/ interno)							•	•	•
Personalizzazione nomi dispositivi	•	•	•	•	•	•	•		
Potenza Amplificatore	Necessario espansore di potenza E30S/E80S	Classe D 40+40W @ 8Ω 70+70W 4Ω	Classe D 30+30W a 8Ω oppure 50+50W a 4Ω	Classe D 80+80W a 8Ω oppure 140+140W a 4Ω	Necessario espansore di potenza E30S/E80S	Classe D 6x15W a 8Ω oppure 6x20W a 4Ω	25+25W a 8Ω stereo	Classe D 30+30W a 8Ω oppure 50+50W a 4Ω	Classe D 80+80W a 8Ω oppure 140+140W a 4Ω
Alimentazione	24 Vdc tramite AL2B in dotazione	24Vdc tramite AL5B/AL6B/AL7B (non in dotazione)		36Vdc tramite AL9B/AL10B/AL203 (non in dotazione)	24Vdc tramite AL2B (non in dotazione)	24Vdc tramite AL6B (non in dotazione)	24Vdc tramite AL3B (non in dotazione)	24Vdc tramite AL5B/AL6B/AL7B (non in dotazione)	36Vdc tramite AL9B/AL10B/AL203 (non in dotazione)
Standard DIN	1 modulo DIN	6 moduli DIN				3 moduli DIN		6 moduli DIN	
Dimensioni (LxHxP) mm	18x90x63	106X90X63				54x90x63		106x90x63	
Peso (Kg)	0,10	0,25	0,20	0,23	0,20	0,25	0,10	0,14	0,14



	KEYSOL-DIN	P40SL	P30S	P80S	MATRIX6	TELEMACO	A25SBTC	E30S	E80S
Multimedia multisource player	•	•	•	•	•	•			
Streaming	Webradio-NAS-Airplay-DLNA-Archivio locale-Spotify connect		Webradio-NAS-Airplay-DLNA- Archivio locale-Spotify connect-Youtube						
App	App Vivaldi (iOS/Android)					App Telemaco (iOS/Android/Windows/MacOs)			
USB Input	•		•	•	•				
Audio Format	MP3/WMA/AAC/AAC+/ALAC/FLAC/APE/WAV								
Bluetooth							play / pause and volume adjustment on board		
RJ45 Input	•	•	•	•	•	•			
Input Audio	1 x unbalanced stereo	1 x unbalanced stereo, 1 x S/PDIF with Toslink and RCA connection	4 x Mono selectable Mic/ Line with activable phantom, 1 x Stereo balanced or 3 x balanced balanced		6 x Mono selezionabile Mic/linea con phantom activable		6 x Mono selectable Mic/ line with activable phantom	1 x balanced stereo	2 x mono or 1 x balanced stereo
Audio Output	1 x balanced stereo				6 x Mono balanced				
Mono output for active subwoofer			•	•					
Amplified output for speakers		•	•	•		•	•	•	•
Equalizer			7 bands		3 bands on every output				
Audio parameter control	To App Vivaldi		To Webpage / App Vivaldi			App Telemaco	Hardware	Hardware	Hardware
Integration home automation system control	with API MQTT, KNX, REST								
Single device with zone source	•	•	•	•	•	•			
Multiple devices with different music on each zone	•	•	•	•	•	•	1 Telemaco (up to 6 zones) 2 Telemaco (up to 12 zones)		
Multiple devices with synced music in all zones	•	•	•	•	•	•			
Alarm clock management with music network	•	•							
DPI switch setup (Mono/Stereo - Volume audio selection)							•	•	•
Customization of Name device	•	•	•	•	•	•	•		
Amplifier power	necessary E30S/ E80S power expansions	Class D 40+40W @ 8Ω 70+70W 4Ω	Classe D 30+30W at 8Ω or 50+50W at 4Ω	Classe D 80+80W at 8Ω or 140+140W at 4Ω	necessary E30S/ E80S power expansions	Classe D 6x15W a 8Ω oppure 6x20W a 4Ω	25+25W at 8Ω	Classe D 30+30W a 8Ω or 50+50W at 4Ω	Classe D 80+80W a 8Ω or 140+140W at 4Ω
Power Supply	24 Vdc via AL2B included	24Vdc via AL5B/AL6B/ AL7B (not included)		36Vdc via AL9B/ AL10B/ AL203 (not included)	24Vdc via AL2B (not included)	24Vdc via AL6B (not included)	24Vdc via AL3B (not included)	24Vdc via AL5B/AL6B/ AL7B (not included)	36Vdc via AL9B/AL10B/ AL203 (not included)
Standard DIN	1 module	6 modules					3 modules	6 modules	
Size (WxHxD) mm	18x90x63	106x90x63					54x90x63	106x90x63	
Weight (Kg)	0,10	0,25	0,20	0,23	0,20	0,25	0,10	0,14	0,14







100V multimediali

# Public Address

sistemi multiplayer WiFi  
con APP

**Multimedia 100V**  
**Public Address applications**  
**Multiplayer WiFi systems with APP**

Mixer amplificati con sorgenti integrate & APP per funzione multiroom  
(WiFi, radio FM, MP3 USB, SD, Bluetooth, LAN)  
Amplified mixer with integrated sources and APP for multiroom



## MA5060BTK

**Mixer amplificato compatto 60W con player integrato per l'ascolto di sorgenti WiFi / radio FM / MP3 USB / SD / Bluetooth.** Telecomando IR in dotazione. Alimentazione AC110-240V & 24Vdc. Consumo 100VA. 6 ingressi miscelabili + sorgenti.

CH1 (priority): mic XLR 5-8mV 600Ω, alimentazione phantom (selezionabile) con funzione Talkover selezionabile.

CH2-3: mic Jack 5-8mV 600Ω / line RCA 150-470mV 10KΩ (commutabili).

CH4-5: line RCA.

CH6: tel. 600Ω 100mV.

Line out RCA: 0,775V (0dBV).

Uscite 4-8-16 Ω - 70/100V. Controllo toni alti/bassi.

Dimensioni 300x88x275 mm (LxHxP). 2U rack.

Standard compatto (necessita di PSK per alloggiamento a rack). Peso 4,0 Kg. Colore cabinet nero, serigrafie arancioni. Cabinet metallo.

**Compact amplifier mixer 60W with player WiFi / radio FM / MP3 USB / SD / Bluetooth integrated.**

IR remote control supplied. Power supply AC110-240V & 24Vdc. Consumption 100VA. 6 mix. Inputs + sources

CH1 (priority): mic XLR 5-8mV 600Ω, Phantom power (selectable) with selectable Talkover function.

CH2-3: mic Jack 5-8mV 600Ω / line RCA 150-470mV 10KΩ (switchable).

CH4-5: line RCA.

CH6: tel. 600Ω 100mV.

Line out RCA: 0,775V (0dBV). Outputs 4-8-16 Ω - 70/100V.

High/Low tones control. Dimensions 300x88x275 mm

(WxHxP). 2U rack. Compact standard (it needs PSK for rack support). Weight 4,0 Kg. Black cabinet, orange screen painting Metal cabinet.

## MA5120BTK

Come MA5060BTK ma **120W**.

Like MA5060BTK but **120W**.



## MA5240BTK

Come MA5120BTK ma **240W**.

Dimensioni 488x88x405 mm (LxHxP).

Standard Rack

Peso 9,0 Kg.

Like MA5120BTK but **240W**.

Dimensioni 488x88x405 mm (WxHxP).

Standard Rack.

Weight 9,0 Kg.



Mixer amplificati multizona con sorgenti integrate & APP, volumi indipendenti (WiFi, radio FM, MP3 USB, SD, Bluetooth, LAN)  
 Multizone amplified mixer with integrated sources and APP, independent volumes



## MZ6120BTK

**Mixer amplificato multizona 120W con player integrato per l'ascolto di sorgenti WiFi / radio FM / MP3 USB / SD / Bluetooth.** Telecomando IR in dotazione. Regolatori di volume a 6 zone indipendenti.  
 Alimentazione AC110-240V & 24Vdc. Consumo 200VA.  
 6 ingressi miscelabili + sorgenti + ingresso emergenza prioritario + base microfonica multizona.  
 CH1 (priority): mic JACK 5-8mV 600Ω.  
 CH2-3-4: mic XLR 5-8mV 600Ω alimentazione phantom (selezionabile) / line XLR 150-470mV 10KΩ (commutabili).  
 CH5-6: line RCA.  
 CH7 EMC: ingresso di emergenza prioritario per messaggi di evacuazione o di servizio.  
 CH8: paging ingresso base microfonica multizona BM6.  
 Funzione MUTE regolabile.  
 Line out RCA: 0,775V (0dBV) uscita dipendente dai canali di ingresso e indipendente dal volume.  
 Uscite 100V. Antenna 75Ω per ricezione RADIO FM.  
 Controllo toni alti/bassi. Dimensioni 484x88x405 mm (LxHxP).  
 2U rack. Peso 8,6 Kg. Colore cabinet nero, serigrafie arancioni. Cabinet metallo. Standard rack.

**Multi-zone amplifier mixer 120W with player WiFi / radio FM / MP3 USB / SD / Bluetooth integrated.**  
 IR remote control supplied. Volume adjustment to 6 independent zones. Power supply AC110-240V & 24Vdc. Consumption 200VA. 6 mix. Inputs + sources + priority emergency input + multi-zone desk microphone.  
 CH1 (priority): mic JACK 5-8mV 600Ω.  
 CH2-3-4: mic XLR 5-8mV 600Ω phantom power (selectable) / line XLR 150-470mV 10KΩ (switchable).  
 CH5-6: line RCA.  
 CH7 EMC: priority emergency input for evacuation or service messages.  
 CH8: paging multi-zone desk microphone input BM6.  
 Mute function adjustable.  
 Line out RCA: 0,775V (0dBV) output dependent on input channels and independent on volume.  
 Output 100V. Antenna 75Ω for reception RADIO FM.  
 High/Low tones control. Dimensions 484x88x405 mm (WxHxD).  
 2U rack. Weight 8,6 Kg. Black cabinet, orange screen painting.  
 Metal cabinet. Standard rack.

## MZ6240BTK

Come MZ6120BTK ma **240W**.  
**Consumo 400VA**.  
 Peso 9,4 Kg.

Like MZ6120BTK but **240W**.  
 Consumption 400VA.  
 Weight 9,4 Kg.

## MZ6350BTK

Come MZ6240BTK ma **350W**.  
**Consumo 500VA**.  
 Peso 9,8 Kg.

Like MZ6240BTK but **350W**.  
 Consumption 500VA.  
 Weight 9,8 Kg.

## MZ6500BTK

Come MZ6350BTK ma **500W**.  
**Consumo 650VA**.  
 Peso 10,25 Kg.

Like MZ6350BTK but **500W**.  
 Consumption 650VA.  
 Weight 10,25 Kg.



Matrici amplificate multizona con sorgenti integrate & APP, musiche e volumi indipendenti (WiFi, radio FM, MP3 USB, SD, Bluetooth, LAN)

Multizone matrices with integrated sources and APP, music and independent volumes



## MS6120BTK

**Matrice amplificata multizona 6x120W con player integrato per l'ascolto di sorgenti WiFi / radio FM / MP3 USB / SD / Bluetooth.**

Telecomando IR in dotazione.

Selezione sorgenti e volumi indipendenti per ogni zona.

Antenna per ricezione radio FM.

Modulo di controllo da remoto CR1 con Bluetooth integrato (max 6).

3 ingressi MIC/LINE + 1 ingresso AUX IN.

CH1 MP3: player WiFi KEYSOL, BLUETOOTH, TUNER FM, USB, SD CARD gestioni delle zone tramite pulsanti.

CH2-3-4: mic COMBO 5-8mV 600Ω alimentazione phantom (selezionabile) / line XLR 150-470mV 10KΩ (commutabili).

CH5: ingresso AUX RCA.

CH6 EMC: ingresso di emergenza prioritario per messaggi di evacuazione o di servizio GRM1.

6 uscite RJ45 per comandi di zona CR1 o basi microfoniche multizona BS6.

2 uscite monitor con controllo volume e pulsante (pannello frontale) per seleziona zona:

- JACK 6,3mm per cuffia sul pannello frontale.

- RCA per diffusori attivi sul pannello posteriore.

Funzione MUTE.

6 line out RCA: 0,775V (0dBV), ogni uscita è controllata dal volume di zona. Uscite altoparlanti 100V, 4-16Ω.

6 display di zona. Morsetti Horn: applicando una tensione continua di 24V si attiva il messaggio preregistrato (interno) per l'evacuazione. Controlli alti e bassi sugli ingressi C2, C3, C4, C5 tramite trimmer. Alimentazione AC110-230V, 24Vdc. Consumo 900VA. Dimensioni 448x88x405 mm (LxHxP).

2U rack. Peso 8 Kg. Colore cabinet nero, serigrafie arancioni. Cabinet metallo. Necessita di PSK per l'alloggiamento a rack.

**6x120W multizone amplified matrix with player for listening to WiFi / FM radio / MP3 USB / SD / Bluetooth sources.**

IR remote control supplied.

Independent source and volume selection for each zone.

Antenna for FM radio reception.

CR1 remote control module with integrated Bluetooth (max 6).

3 MIC/LINE inputs + 1 AUX IN input.

CH1 MP3: WiFi player KEYSOL, BLUETOOTH, TUNER FM, USB, SD CARD zone management via buttons.

CH2-3-4: mic COMBO 5-8mV 600Ω phantom power supply (selectable) / line XLR 150-470mV 10KΩ (switchable).

CH5: RCA AUX input.

CH6 EMC: Priority emergency entry for evacuation or service messages Vivaldi Ulisse GRM1.

6 RJ45 outputs for CR1 zone commands or BS6 multizone microphone bases.

2 monitor outputs with volume control and button (front panel) to select area:

- 6.3mm headphone jack on the front panel.

- RCA for active speakers on the rear panel.

MUTE function.

6 RCA line out: 0.775V (0dBV), each output is controlled by the zone volume. Speaker outputs 100V, 4-16Ω. 6 zone displays.

Horn terminals: applying a DC voltage of 24V activates the pre-recorded (internal) message for evacuation.

High and low controls on C2, C3, C4, C5 inputs via trimmer.

Power supply AC110-230V, 24Vdc. Consumption 900VA.

Dimensions 448x88x405 mm (WxHxD).

2U rack. Weight 8 Kg.

Black cabinet color, orange serigraphs.

Metal cabinet. Requires PSK for rack housing.

## MS6240BTK

Come MS6120BTK ma **6x240W**.

Like MS6120BTK but **6x240W**.

## Basi microfoniche e controlli di zona Microphone bases and zone control

### BM6



**Base microfonica multizona, paging, remota, da tavolo, con pulsanti, per amplificatori MZ6120BTK, MZ6240BTK, MZ6350BTK e MZ6500BTK.**

Chiamata a 6 zone. Priorità tramite gli interruttori dip switch. 6 pulsanti selezione zone. Connettore microfono gooseneck. Indicatori alimentazione, comunicazione, occupato, zona. Pulsante chiama/parla. Interruttore ON/OFF. Porta RJ45 per connettere la base successive in cascata. Porta RJ45 di comunicazione con l'amplificatore. Controllo gain microfono. Asta da 41cm. Ingresso Aux locale. Alimentazione tramite link all'amplificatore con cavo CAT6 connettore RJ45. Linkabile in cascata (fino a 6 basi) per una lunghezza massima di 300mt (amplificatore - ultima base). Peso 0,9 Kg.



**Multi-zone, paging, remote, desktop, push button microphone base for MZ6120BTK, MZ6240BTK, MZ6350BTK and MZ6500BTK amplifiers.**

6-zone call. Priority via dip switches. 6 zone selection buttons. Gooseneck microphone connector. Indicators power, communication, busy, zone. Call/speak button. ON/OFF switch. RJ45 port to connect the next base station in daisy chain. RJ45 port to communicate with the amplifier. Microphone gain control. 41cm rod. Local Aux entrance. Power supply via link to the amplifier with CAT6 cable RJ45 connector. Daisy chain linkable (up to 6 bases) for a maximum length of 300mt (amplifier - last base). Weight 0,9 Kg.

### BS6



come BM6 ma per matrici **MS6120BTK e MS6240BTK**



as BM6 for **MS6120BTK and MS6240BTK** matrices

### CR1



**Controllo remoto di zona, touch panel, da incasso. Per matrici MS6120BTK e MS6240BTK.**

Ogni matrice gestisce fino a 6 CR1 (controlli di zona indipendenti). Alimentazione tramite link all'amplificatore con cavo CAT5E/CAT6 connettore RJ45, lunghezza massima di 200mt per singola linea. Dimensioni (LxHxP) 86x86x35 mm. Peso 0,2kg. Colore bianco satinato, serigrafato, retroilluminato. Necessita di scatola da incasso SC100 (da ordinare a parte). Note: il controllo remoto di zona CR1 viene indirizzato di fabbrica (assegnazione numero di zona). In fase d'ordine indicare il numero di zone richieste. La centrale supporta fino a 6 dispositivi tra CR1 e basi microfoniche BS6.

**Remote zone control, touch panel, recessed. For MS6120BTK e MS6240BTK arrays.**

Each matrix handles up to 6 CR1s (independent zone controls). Power supply via link to the amplifier with CAT5E/CAT6 cable RJ45 connector, maximum length of 200mt per single line. Size (WxHxD) 86x86x35 mm. Weight 0,2kg. Satin white color, silk-screened, backlit. Requires built-in box SC100 (not included). Note: CR1 zone remote control should be addressed from the factory (zone number assignment). When ordering, indicate the number of zones required. The control panel supports up to 6 devices between CR1 and BS6 microphone bases.

### SC100



Scatola da incasso per controllo remoto di zona, touch panel CR1. Colore bianco. Peso: 0,15Kg.

Built-in box for remote control of the area, CR1 touch panel. Color: white. Weight: 0,15Kg.



## PMA2120

**Finale di potenza stereo 100V classe D, a risparmio energetico. Potenza 120W x 2 a 8Ω / 100V.**  
 Alimentazione 24Vdc 230V. Consumo 280VA.  
 Ingressi con connettori a morsetti bilanciati.  
 Uscite generali altoparlanti 8Ω/100V. Dimensioni (LxHxP) 482x44x420 mm. 1U rack. Peso 7 Kg.  
 Colore nero. Alette per montaggio a rack incorporate.

**Class D, power stereo amplifier 100V, energy saving Power 120W x 2 at 8Ω / 100V.** Power supply 24 Vdc 230V. Consumption 280 VA. Inputs with balanced terminal connectors. General speaker outputs 8Ω/100V. Size (WxHxP) 482x44x420 mm. 1U rack. Weight 7Kg. Black colour. Inputs with balanced terminal connectors.



## PMA2240

**Finale di potenza stereo 100V classe D, a risparmio energetico. Potenza 240W x 2 a 8Ω / 100V.**  
 Alimentazione 24Vdc 230V. Consumo 520VA. Ingressi con connettori a morsetti bilanciati. Uscite generali altoparlanti 8Ω/100V. Dimensioni (LxHxP) 482x44x420 mm. 1U rack. Peso 7,3 Kg. Colore nero. Alette per montaggio a rack incorporate.

**Class D, power stereo amplifier 100V, energy saving. Power 240W x 2 at 8Ω / 100V.** Power supply 24Vdc 230V. Consumption 520VA. Inputs with balanced terminal connectors. General loudspeaker output 8Ω/100V. Size (WxHxP) 482x44x420 mm. 1U rack. Weight 7,3 Kg. Black colour. Flaps for rack mounting included.

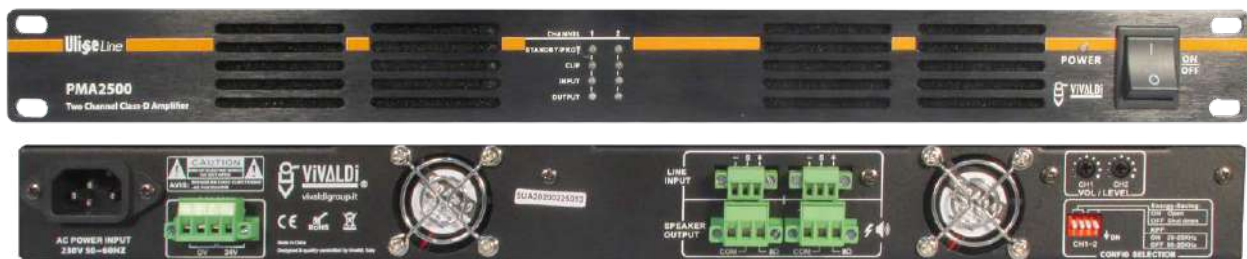

## PMA2500

**Finale di potenza stereo 100V in classe D, a risparmio energetico. Potenza 500W x 2 a 8Ω / 100V.**  
 Alimentazione 24Vdc 230V. Consumo 1050VA. Ingressi con connettori a morsetti bilanciati. Uscite generali altoparlanti 8Ω/100V. Dimensioni (LxHxP) 482x44x420 mm. 1U rack. Peso 8,2 Kg. Colore nero. Alette per montaggio a rack incorporate.

**Class D, power stereo amplifier 100V, energy saving. Power 500W x 2 a 8Ω / 100V.** Power supply 24Vdc 230V. Consumption 1050VA. Inputs with balanced terminal connectors. General loudspeaker Output 8Ω/100V. Size (LxHxP) 482x44x420 mm. 1U rack. Weight 8,2 Kg. Black colour. Flaps for rack mounting included.





## PSA300MK2

**Finale di potenza stereo 4-16 Ω in Classe D, a risparmio energetico. Potenza 300W x 2 a 4Ω. Potenza 180W x 2 a 8 Ω.** Potenza a ponte 600W a 8 Ω (non accetta collegamenti di impedenze inferiori a 8 Ω). Risposta in frequenza 20-20000Hz +/-0,5dB. Alimentazione 115V-230V commutabile. Consumo 600VA. Presa COMBO Jack bil 6,3mm / XLR bil. Uscite generali altoparlanti 4-16 Ω speakon -morsetti (in dotazione). Ingressi 10KΩ unb, 20KΩ bil, 1V RMS@1Khz. Rapporto segnale rumore 100dB. Distorsione armonica totale 0.05% / 1W / per canale. Dimensioni 482x44x180 mm (LxHxP). Peso 2,6 Kg. Colore nero serigrafato arancione. Alette per montaggio a rack incorporate.

**Class D, power stereo amp 4-16 Ω, energy saving. Power 300W x 2 to 4 Ω. Power 180W x 2 to 8 Ω.** Bridge power 600W at 8 Ω (does not accept connections of impedances less than 8 Ω). Frequency response 20-20000Hz +/-0.5dB. Power supply 115V-230V switchable. Consumption 600VA. Socket COMBO Jack bal 6,3mm / XLR bal. General outputs speakers 4-16Ω speakon -terminals (included). Inputs 10KΩ unb, 20KΩ bal, 1V RMS@1Khz. Signal to noise ratio 100dB. Total harmonic distortion 0.05% / 1W / per channel. Size 482x44x180 mm (WxHxD). Weight 2,6 Kg. Black color silk-screened orange. Flap for rack mounting included.



## PSA500MK2

**Finale di potenza stereo 4-16 Ω in Classe D, a risparmio energetico. Potenza 450W x 2 a 4 Ω. Potenza 250W x 2 a 8 Ω.** Potenza a ponte 900W a 8 Ω (non accetta collegamenti di impedenze inferiori a 8 Ω). Risposta in frequenza 20-20000Hz +/-0,5dB. Alimentazione 115V-230V commutabile. Consumo 1000VA. Presa COMBO Jack bil 6,3mm / XLR bil. Uscite generali altoparlanti 4-16 Ω speakon -morsetti (in dotazione). Ingressi 10KΩ unb, 20KΩ bil, 1V RMS@1Khz. Rapporto segnale rumore 100dB. Distorsione armonica totale 0.05% / 1W / per canale. Dimensioni 482x44x180 mm (LxHxP). Peso 2,8 Kg. Colore nero serigrafato arancione. Alette per montaggio a rack incorporate.

**Class D, power stereo amp 4-16 Ω, energy saving. Power 450W x 2 to 4 Ω. Power 250W x 2 at 8 Ω.** 900W bridge power at 8 Ω (does not accept impedance connections of less than 8 Ω). Frequency response 20-20000Hz +/-0.5dB. Power supply 115V-230V switchable. Consumption 1000VA. Socket COMBO Jack bil 6,3mm / XLR bil. General outputs speakers 4-16 Ω speakon -clamps (included). Inputs 10KΩ unb, 20KΩ bil, 1V RMS@1Khz. 100dB signal to noise ratio. Total harmonic distortion 0.05% / 1W / per channel. Size 482x44x180 mm (WxHxD). Weight 2,8 Kg. Black color silk-screened orange. Flap for rack mounting included.





## PS1000

**Finale di potenza stereo 4-16 Ω in Classe D, a risparmio energetico. Potenza 500W x 2 a 4 Ω. Potenza 350W x 2 a 8 Ω.** Alimentazione 230V. Ingresso Program XLR bil.  
Link Out XLR bil. Uscite generali altoparlanti 4-16 Ω speakon (in dotazione).  
Dimensioni 484x44x375 mm (LxHxP) maniglie incluse.  
Peso 7,5 Kg. Colore nero.  
Alette per montaggio a rack incorporate.

**Power stereo amp 4-16 Ω, D class, energy saving. Power 500W x 2 at 4 Ω. Power 350W x 2 at 8 Ω.**  
Power supply 230V. Phantom Input XLR bal.  
Link Out XLR bal. General loudspeaker output 4-16 Ω speakon (included).  
Size 484x44x375 mm (WxHxD) handles included  
Weight 7,5 Kg. Black colour.  
Flaps for rack mounting included.



## PS3000

**Finale di potenza stereo 4-16 Ω in Classe D, a risparmio energetico. Potenza 1600W x 2 a 4 Ω. Potenza 850W x 2 a 8 Ω.** Alimentazione 230V. Ingresso Program XLR bil.  
Link Out XLR bil. Uscite generali altoparlanti 4-16 Ω speakon (in dotazione).  
Dimensioni 484x44x375 mm (LxHxP) maniglie incluse.  
Peso 8,8 Kg. Colore nero. Alette per montaggio a rack incorporate.

**Power stereo amp 4-16 Ω, D class, energy saving. Power 1600W x 2 at 4 Ω. Power 850W x 2 at 8 Ω.**  
Power supply 230V. Phantom Input XLR bal. Link Out XLR bal. General loudspeaker output 4-16 Ω speakon (included).  
Size 484x44x375 mm (WxHxD) handles included  
Weight 8,8 Kg. Black colour. Flaps for rack mounting included.



## PSA4300

**Finale di potenza 4 canali 4-8 Ω.**

**Potenza 4x350W a 4 Ω. Potenza 4x200W a 8 Ω.** Risposta in frequenza 20Hz-20KHz. Alimentazione 220-240V 50/60Hz. Presa XLR bil.

Uscite generali altoparlanti 4-16 Ω speakon (in dotazione). Ingressi 20KΩ bil/ 10KΩ unb.

Rapporto segnale rumore >105dB. Distorsione armonica totale 0.3%. Dimensioni 484x44x375 mm (LxHxP) maniglie incluse. Peso 5 Kg. Colore nero.

Alette per montaggio a rack incorporate.

**Power amplifier 4 channels 4-8 Ω.**

**Power 4x350W at 4 Ω. Power 4x200W at 8 Ω.** Frequency response 20Hz-20KHz. Power supply 220-240V 50/60Hz.

XLR bal. Socket. General loudspeaker output 4-16 Ω speakon (included). Inputs 20KΩ bal/ 10KΩ unb. >105dB signal noise report.

Total harmonic distortion 0.3%.

Size 484x44x375 mm (WxHxP) handles included Weight 5 Kg. Black colour. Flaps for rack mounting included.



## PSA4500

**Finale di potenza 4 canali 4-8 Ω.**

**Potenza 4x500W a 4 Ω. Potenza 4x350W a 8 Ω.** Risposta in frequenza 20Hz-20KHz. Alimentazione 220-240V 50/60Hz. Presa XLR bil.

Uscite generali altoparlanti 4-16 Ω speakon (in dotazione). Ingressi 20KΩ bil/ 10KΩ unb.

Rapporto segnale rumore >105dB.

Distorsione armonica totale 0.3%.

Dimensioni 484x44x375 mm (LxHxP) maniglie incluse.

Peso 8,5 Kg. Colore nero.

Alette per montaggio a rack incorporate.

**Power amplifier 4 channels 4-8 Ω.**

**Power 4x500W at 4 Ω. Power 4x350W at 8 Ω.**

Frequency response 20Hz-20KHz.

Power supply 220-240V 50/60Hz.

XLR bal. Socket.

General loudspeaker output 4-16 Ω speakon (included).

Inputs 20KΩ bal/ 10KΩ unb.

>105dB signal noise report.

Total harmonic distortion 0.3%.

Size 484x44x375 mm (WxHxP) handles included Weight 8,5 Kg. Black colour. Flaps for rack mounting included.



## PSA6500

**Finale di potenza 6 canali 4-8 Ω. Potenza 6x500W a 4 Ω. Potenza 6x350W a 8 Ω.** Risposta in frequenza 20Hz-20KHz. Alimentazione 220-240V 50/60Hz. Ingressi e uscite generali altoparlanti 4-16 Ω morsetti. Ingressi 20KΩ bil/ 10KΩ unb. Rapporto segnale rumore >105dB. Distorsione armonica totale 0.3%. Dimensioni 484x44x430 mm (LxHxP) maniglie incluse. Peso 9,3 Kg. Colore nero. Alette per montaggio a rack incorporate.

**Power amplifier 6 channels 4-8 Ω. Power 6x500W at 4 Ω. Power 6x350W at 8 Ω.** Frequency response 20Hz-20KHz. Power supply 220-240V 50/60Hz. General loudspeaker input and output 4-16 Ω clamps. Inputs 20KΩ bal/ 10KΩ unb. >105dB signal noise report. Total harmonic distortion 0.3%. Size 484x44x375 mm (WxHxP) handles included. Weight 9,3 Kg. Black colour. Flaps for rack mounting included.



## PSA8500

**Finale di potenza 8 canali 4-8 Ω. Potenza 8x500W a 4 Ω. Potenza 8x350W a 8 Ω.** Risposta in frequenza 20Hz-20KHz. Alimentazione 220-240V 50/60Hz. Ingressi e uscite generali altoparlanti 4-16 Ω morsetti. Ingressi 20KΩ bil/ 10KΩ unb. Rapporto segnale rumore >105dB. Distorsione armonica totale 0.3%. Dimensioni 484x44x430 mm (LxHxP) maniglie incluse. Peso 10,9 Kg. Colore nero. Alette per montaggio a rack incorporate.

**Power amplifier 8 channels 4-8 Ω. Power 8x500W at 4 Ω. Power 8x350W at 8 Ω.** Frequency response 20Hz-20KHz. Power supply 220-240V 50/60Hz. General loudspeaker input and output 4-16 Ω clamps. Inputs 20KΩ bal/ 10KΩ unb. >105dB signal noise report. Total harmonic distortion 0.3%. Size 484x44x375 mm (WxHxP) handles included. Weight 10,9 Kg. Black colour. Flaps for rack mounting included.



## DA8

**Distributore di segnali audio a doppia modalità:** 1 ch input e 8 uscite bilanciate 2 ch input e 4 uscite bilanciate Ground Lift attivabile per ogni morsetto d'uscita tramite DIP switch. 8 trimmer di controllo per attenuazione uscite. Rapporto segnale 1:1. Alimentazione 12-36Vdc tramite AL2B (da ordinare a parte). Standard DIN (6 moduli). Dimensioni 106x90x63 mm (LxHxP). Peso 0,1 Kg.

**Dual mode audio signal distributor:** 1 ch input and 8 balanced outputs 2 ch input and 4 balanced outputs Ground Lift can be activated for each output terminal via DIP switch. 8 control trimmers for output attenuation. 1:1 signal ratio. Power supply 12-36Vdc via AL2B (not included). DIN standard (6 modules). Size 106x90x63 mm (WxHxD). Weight 0,1 Kg.



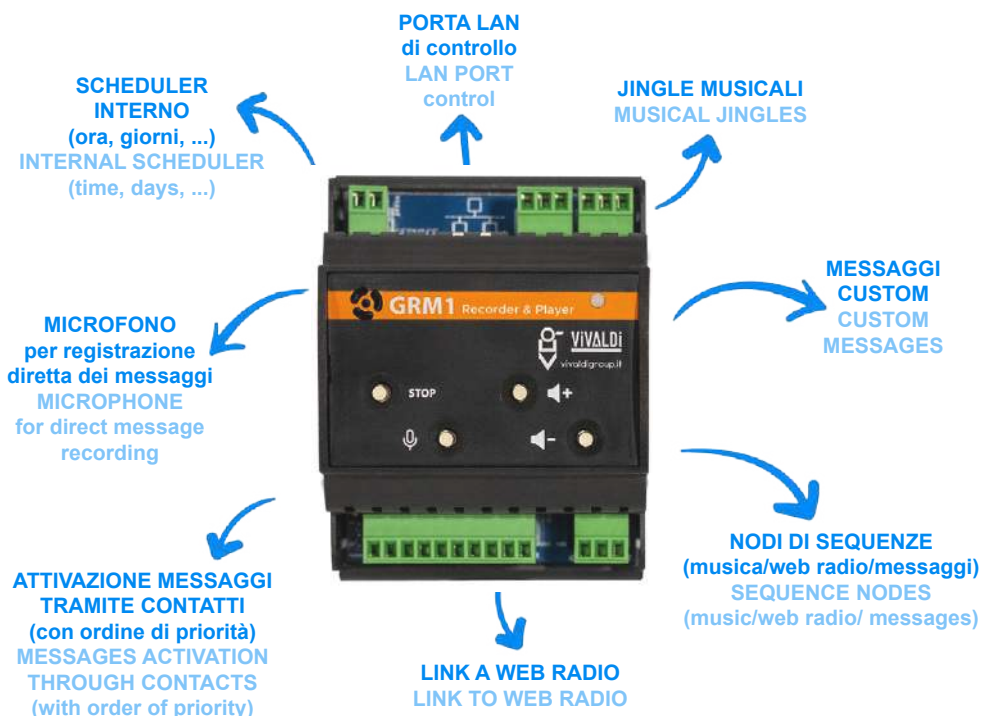

## GRM1

**Registratore, generatore di messaggi di evacuazione, allarme, sicurezza o pubblicità.**

Ideale per luoghi di culto, scuole, supermercati, aeroporti, abitazioni, musei, ...

Possibilità di riprodurre Jingle musicali come messaggi.

Possibilità di gestire WebRadio da Timer.

Possibilità di creare nodi con sequenze musica/link web radio/messaggi a piacere.

Attivazione messaggi tramite contatti (timer o impianti di sicurezza tipo antincendio o vigilanza).

**Numero messaggi registrabili: 100.**

**Tempo totale: 120 minuti.**

**Memoria interna 16GB.**

Lettura di file multimediali: MP3, FLAC, WAV.

Scheduler interno per programmazione timer a orario/giorni/settimane/mesi.

**1 ingresso LAN per connessione alla rete (interfaccia di gestione per file, schedulazioni e contatti).**

Aggiornamenti da remoto.

**8 contatti in Ingresso per l'attivazione dei messaggi, in ordine di priorità (1° = priorità max, 8° = priorità min)**

1 microfono integrato per registrazione messaggi, pulsante sul frontale.

**1 contatto pulito di uscita per attivazione di apparecchiature con contatto prioritario.**

Tasti funzione: volume +/-, mic, stop.

Note: può essere integrato a iCONTROL4.0+ equipaggiato di batteria tampone, in caso di mancata corrente mantiene la programmazione. Alimentazione: 24 Vdc (alimentatore non incluso AL2B). Consumo: 200 mA.

Certificazioni: RoHS, CE.

Dimensioni (LxHxD) 72x90x63 mm. Peso 0,2 Kg.

Predisposizione guida DIN 4 moduli.

**GRM1 is a message player, recorder and scheduler for alarm, evacuation, planning and commercial announcements.** Ideal for worship places, schools, supermarkets, airports, homes, museums,...

Possibility to make musical Jingles as messages.

Possibility to link WebRadio with Timer.

Possibility to create playlists with music/link web radio/ messages sequences, at will..

**Messages activation by contacts (timer or security like fire or surveillance).**

**Total time: 120 minutes. Internal memory 16GB.**

Multimedial files reading: MP3, FLAC, WAV.

Internal scheduler for timer planning to timetable/days/ weeks/months.

**1 LAN input for network connection (interface for files manager, scheduling and contacts).**

**8 inputs contacts for messages activation in order of priority (1° = max priority, 8° = min priority)**

1 integrated microphone input for recording messages, switch on front panel.

**1x output (clean) contact for the activation of equipment with priority contact.**

Functions switch: volume +/-, mic, stop.

Backup battery included, in case of power failure holds programming.

Power supply 24 Vdc (power supply not included AL2B Consumption: 200 mA.

Certifications: RoHS, CE.

Size (WxHxD) 72x90x63 mm.

Weight 0,2 Kg Din guide 4 modules.





# Diffusori di Stile

Style Speakers





**INVISIBLE65**  
**INVISIBLE65T**  
**SUBINVISIBLE50**  
**SUBINVISIBLE50T**

**Campi applicativi**  
**Application fields**



	<b>INVISIBLE65</b>	<b>INVISIBLE65T</b>	<b>SUBINVISIBLE50</b>	<b>SUBINVISIBLE50T</b>
Descrizione / Description	Diffusore (trasduttore) per retro superfici piane e rigide, HiFi / Speaker (transducer) for retro flat and rigid surfaces, HiFi		Subwoofer (trasduttore) per retro superfici piane e rigide, HiFi / Subwoofer (transducer) for flat and rigid back surfaces, HiFi	
Driver	1,25" (32mm)	1,25" (32mm)	2,25" (57mm).	2,25" (57mm).
Magnete / Magnet	neodimio / neodymium	neodimio / neodymium	neodimio / neodymium	neodimio / neodymium
Membrana / Diaphragm	ABS	ABS		
Potenza RMS / musicale RMS / Music Power	40W/80W	---	50W/100W	---
Potenza nominale / peak Nominal power / peak	---	3,75/7,5/15/30W 60W peak, max 100dB	---	5/10/20/50W RMS 100W peak
Amplificazione consigliata Recommended amplification	da 20 a 60W RMS 20 to 60W RMS	---	da 40 a 100W RMS 40 to 100W RMS	---
Impedenza / Tensione trasformatore Impedance / Transformer voltage	8Ω	100V	8Ω	100V
Risposta in frequenza / Sensibilità Frequency Response / Sensitivity	60-20000 Hz +-6dB / 85dB	60-20000 Hz +-6dB / 85dB	40-500 Hz +-8dB / 85dB	40-500 Hz +-8dB / 85dB
Dimensioni (LxHxP) / Size (WxHxD)	58,5x68,5x20 mm	58,5x68,5x20 mm	115x46x115 mm	115x46x115 mm
Peso / Weight	0,22 kg	0,22 kg	1,2 kg	1,2 kg
Fissaggio / Fixing	con 4 viti o adesivo per vetro with 4 screws or glass adhesive		con 4 viti o adesivo per vetro with 4 screws or glass adhesive	
	La resa acustica è direttamente proporzionale alla rigidità ed alla tipologia del materiale usato per la vibrazione The acoustic performance is directly proportional to the rigidity and the type of material used for vibration			
	esempio di superfici / example of surfaces vetro: ottima / glass: excellent legno: buona / Wood: good cartongesso: sufficiente / drywall: sufficient murature, laterizi, cemento: non adatte / masonry, bricks, cement: not suitable polistirolo o simili: non adatti / polystyrene or similar: not suitable			
Note	---	Attenzione: il trasformatore dovrà essere installato ad una distanza di almeno 1mt dall'Invisible o vicino all'amplificatore/quadro rack. Attention: the transformer must be installed at a distance of at least 1 meter from the INVISIBLE or near the amplifier / rack panel.	---	Attenzione il trasformatore non dovrà essere installato sulla superficie vibrante Attention the transformer should not be installed on the vibrating surface but preferably near the amplifier.

**GHOST930**  
**SC930**  
**GHOST930SUB**

**Campi applicativi**  
**Application fields**



GHOST930



SC930

	<b>GHOST930</b>	<b>GHOST930SUB</b>
Descrizione / Description	Diffusore per retro superfici piane e rigide, HiFi Speaker for retro flat and rigid surfaces, HiFi	Subwoofer per retro superfici piane e rigide, HiFi Subwoofer for rear of flat and rigid surfaces
Woofer	4 trasduttori magneto dinamici a gamma larga 4 wide range dynamic magnet transducers	2 trasduttori magneto dinamici per subwoofer 2 dynamic sub-transducers
Membrana / Diaphragm	ABS	ABS
Potenza RMS / Musicale RMS / Music Power	160W / 320W	100W / 200W
Amplificazione consigliata Recommended amplification	da 80 a 200W RMS 80 to 200W RMS	da 80 a 200W RMS 80 to 200W RMS
Impedenza / Impedance	8Ω	4Ω
Risposta in frequenza Frequency response	60-20000 Hz +-6dB	40-200 Hz +-6dB
Sensibilità / Sensibility	86dB	86dB
Dimensioni senza controcassa (LxHxP) Size without casing (WxHxD)	370x550x40 mm	370x550x40 mm
Dimensioni con controcassa SC930 (LxHxP) Size with casing SC930 (WxHxD)	370x550x68 mm	370x550x68 mm
Foro da incasso / Recessed hole	(LxHxP) / (WxHxD) 370x550x68 mm	(LxHxP) / (WxHxD) 370x550x68 mm
Peso / Weight	1,5 kg	2,5 kg
Colore / Color		
Cabinet	legno / wood	legno / wood
	esterno verniciato bianco, interno legno naturale / exterior white painted wood, interior natural wood	
Fissaggio / Fixing	a vite sul cartongesso, a muro tramite SC930 drywall screw, wall through, SC930	a vite sul cartongesso, a muro tramite SC930 drywall screw, wall through, SC930
Note	Installabile sottotraccia anche su muro (laterizi, cemento) tramite apposita controcassa SC930 Can be installed under the track also on the wall (bricks, concrete) through a special SC930 casing	



## GIADA13F



**GIADA13F.R** (min 10pz, colore personalizzabile/ min 10 pcs custom color)

## GIADA13TF



**GIADA13TF.R** (min 10pz, colore personalizzabile/ min 10 pcs custom color)

## GIADA13AF



**GIADA13AF.R** (min 10pz, colore personalizzabile/ min 10 pcs custom color)

**RG13FB** retina black per GIADA13F/TF/AF

### Campi applicativi Application fields



	GIADA13F	GIADA13TF	GIADA13AF
Descrizione / Description	Diffusore rettangolare, 2 vie da incasso, HiFi, Frameless Rectangular speaker, 2 way recessed, HiFi, Frameless		
Woofer	13,5 cm kevlar	13,5 cm kevlar	13,5 cm kevlar
Tweeter orientabile / adjustable	a cupola 2,5 cm dome 2.5 cm	a cupola 2,5 cm dome 2.5 cm	a cupola 2,5 cm dome 2.5 cm
Magnete tweeter / tweeter magnet	neodimio / neodymium	neodimio / neodymium	neodimio / neodymium
Membrana tweeter/ tweeter diaphragm	seta / silk	seta / silk	seta / silk
Potenza RMS / musicale RMS / Music Power	40W/80W	---	50W/100W
Potenza nominale / peak Nominal power / peak	---	3,75/7,5/15W 30W peak, max 104dB	---
Amplificazione consigliata Recommended amplification	da 10 a 50W RMS 10 to 50W RMS	---	---
Impedenza / Tensione trasformatore Impedance / Transformer voltage	8Ω	100V	attivo / active
Risposta in frequenza / Sensibilità Frequency Response / Sensitivity	70-20000 Hz/90dB	70-20000 Hz/89dB	70-20000 Hz/90dB
Angolo di dispersione / Dispersion angle	120° (V/O)	120° (V/O)	120° (V/O)
Alimentazione / Power supply	---	---	tramite AL3B / via AL3B
Dimensioni (LxHxP) / Size (WxHxD)	175x267x75 mm	175x267x80 mm	175x267x85 mm
Foro da incasso (LxH) / Recessed hole (WxH)	153x245 mm	153x245 mm	153x245 mm
Peso / Weight	1,3 kg	1,4 kg	1,6 kg
Colore / Color	bianco RAL 9016 white RAL 9016	bianco RAL 9016 white RAL 9016	bianco RAL 9016 white RAL 9016
Cabinet	ABS V0 con griglia di protezione zincata verniciata / ABS V0 with painted galvanized grille		
Incasso su muratura/ Recessed on masonry	SR1	SR1	SR1
Incasso su cartongesso Flush mounting plasterboard	non servono accessori, il diffusore nel retro è dotato di ganci per l'ancoraggio stabile no accessories needed, the speaker is provided with hook shaped anchors for stable fixing in the rear		

## PERLA13P

 **PERLA13P.R** (min 10pz, colore personalizzabile/ min 10 pcs custom color)





## PERLA13TP

 **PERLA13TP.R** (min 10pz, colore personalizzabile/ min 10 pcs custom color)

### Campi applicativi Application fields



	PERLA13P	PERLA13TP
Descrizione / Description	Diffusore rettangolare, 2 vie da incasso, HiFi / Rectangular speaker, 2 way recessed, HiFi	
Woofer	13,5 cm	13,5 cm
Tweeter orientabile / adjustable	a cupola 2,5 cm / dome 2.5 cm	a cupola 2,5 cm / dome 2.5 cm
Magnete tweeter / tweeter magnet	neodimio / neodymium	neodimio / neodymium
Membrana tweeter/ tweeter diaphragm	titanio / titanium	titanio / titanium
Potenza RMS / musicale RMS / Music Power	50W/100W	---
Potenza nominale / peak Nominal power / peak	---	3,75/7,5/15W 30W peak, max 106dB
Amplificazione consigliata Recommended amplification	da 10 a 60W RMS 10 to 60W RMS	---
Impedenza / Tensione trasformatore Impedance / Transformer voltage	8Ω	100V
Risposta in frequenza / Sensibilità Frequency Response / Sensitivity	55-20000 Hz/89dB	60-20000 Hz/91dB. max 1mt 102dB
Angolo di dispersione Dispersion angle	120° (V/O)	120° (V/O)
Dimensioni (LxHxP) / Size (WxHxD)	236x306x53 mm	236x306x53 mm
Foro da incasso (LxH) Recessed hole (LxH)	170x250 mm	170x250 mm
Peso / Weight	1,8 kg	1,9 kg
Colore / Color	bianco RAL 9016 / white RAL9016	bianco RAL 9016 / white RAL9016
Cabinet	MDF verniciato, griglia in acciaio verniciato / Painted MDF, Painted Steel Grille	
Incasso su tramezze o pareti sottili Recessed on partitions or thin walls	SR1S/CF2	SR1S/CF2
Incasso su muratura Recessed on masonry	SR1/CF2	SR1/CF2
Incasso su cartongesso Recessed on plasterboard	non servono accessori, il diffusore nel retro è dotato di ganci per l'ancoraggio stabile no accessories needed, the speaker is provided with hook shaped anchors for stable fixing in the rear	

-  **GIADA16F**  
**GIADA16F.R** (min 10pz, colore personalizzabile/ min 10 pcs custom color)
-  **GIADA16TF**  
**GIADA16TF.R** (min 10pz, colore personalizzabile/ min 10 pcs custom color)
-  **GIADA16AF**  
**GIADA16AF.R** (min 10pz, colore personalizzabile/ min 10 pcs custom color)
- RG16FB** retina black RAL9004 per GIADA16F/TF/AF
- GIADA16HPF**
-  **GIADA16HPF.R** (min 10pz, colore personalizzabile/ min 10 pcs custom color)
- GIADA16HPFA**
-  **GIADA16HPFA.R** (min 10pz, colore personalizzabile/ min 10 pcs custom color)

### Campi applicativi Application fields



	<b>GIADA16F</b>	<b>GIADA16TF</b>	<b>GIADA16AF</b>	<b>GIADA16HPF</b>	<b>GIADA16HPFA</b>
Descrizione / Description	Diffusore rettangolare, da incasso, 2 vie, HiFi, Frameless / Rectangular speaker, recessed, 2 way, HiFi, Frameless				
Woofer	16,5 cm kevlar	16,5 cm kevlar	16,5 cm kevlar	16,5 cm	16,5 cm
Tweeter orientabile / adjustable	a cupola 2,5 cm dome 2.5 cm	a cupola 2,5 cm dome 2.5 cm	a cupola 2,5 cm dome 2.5 cm	a cupola 2,5 cm dome 2,5 cm	a cupola 2,5 cm dome 2,5 cm
Magnete tweeter / tweeter magnet	neodimio / neodymium	neodimio / neodymium	neodimio / neodymium	neodimio / neodymium	neodimio / neodymium
Membrana tweeter/ tweeter diaphragm	seta / silk	seta / silk	seta / silk	seta e titanio silk and titanium	seta e titanio silk and titanium
Potenza RMS / musicale RMS / Music Power	60W/120W	---	50W/100W	80W/160W	50W/100W
Potenza nominale / peak Nominal power / peak	---	3,75/7,5/15W 30W peak, max 105dB	---	---	3,75/7,5/15W 30W peak, max 105dB
Amplificazione consigliata Recommended amplification	da 10 a 70W RMS 10 to 70W RMS	---	---	da 10 a 100W RMS 10 to 100W RMS	---
Impedenza / Tensione trasformatore Impedance / Transformer voltage	8Ω	100V	attivo / active	4-8Ω selezionabile 4-8Ω selectable	attivo / active
Risposta in frequenza / Sensibilità Frequency Response / Sensitivity	60-20000 Hz/90dB	60-20000 Hz/90dB	60-20000 Hz/90dB	45-22000Hz/88dB	45-22000Hz/109dB
Angolo di dispersione /Dispersion angle	120° (V/O)	120° (V/O)	120° (V/O)	120° (V/O)	120° (V/O)
Alimentazione / Power supply	---	---	tramite AL3B via AL3B	---	tramite AL3B via AL3B
Dimensioni (LxHxP) / Size (WxHxD)	205x300x86 mm	205x300x90 mm	205x300x96 mm	219x306x96 mm	219x306x96 mm
Foro da incasso (LxH) Recessed hole (WxH)	186x280 mm	186x280 mm	186x280 mm	190x275 mm	190x275 mm
Peso / Weight	1,6 Kg	1,7 kg	1,8 kg	2,1 kg	2,4 kg
Colore / Color	bianco RAL 9016 white RAL 9016	bianco RAL 9016 white RAL 9016	bianco RAL 9016 white RAL 9016	bianco RAL 9016 white RAL 9016	bianco RAL 9016 white RAL 9016
Cabinet	ABS V0 con griglia di protezione zincata verniciata / ABS V0 with painted galvanized grille				
Incasso su muratura Recessed on masonry	SR2	SR2	SR2	SR2	SR2
Incasso su cartongesso Flush mounting plasterboard	non servono accessori, il diffusore nel retro è dotato di ganci per l'ancoraggio stabile no accessories needed, the speaker is provided with hook shaped anchors for stable fixing in the rear				

-  **GIADA16HP** EOL
-  **GIADA16HP.R** (min 10pz, colore personalizzabile/ min 10 pcs custom color) EOL
- GIADA16HPA** EOL
-  **GIADA16HPA.R** (min 10pz, colore personalizzabile/ min 10 pcs custom color) EOL
- GIADA213HP** EOL
- IP44** **GIADA213HP.IP** EOL
-  **GIADA213HP.R** (min 10pz, colore personalizzabile/ min 10 pcs custom color) EOL
- GIADA213HPF**
-  **GIADA213HPF.R** (min 10pz, colore personalizzabile/ min 10 pcs custom color)

**Campi applicativi**  
Application fields



	<b>GIADA16HP</b>	<b>GIADA16HPA</b>	<b>GIADA213HP</b>	<b>GIADA213HPF</b> frameless
Descrizione / Description	Diffusore rettangolare TOP CLASS da incasso HiFi rectangular speaker TOP CLASS recessed HI-FI			
	2 vie / 2 way	2 vie / 2 way	3 vie / 3 way	3 vie / 3 way
Utilizzo negli Home Cinema	canale anteriore e posteriore front and rear channel	---	canale centrale, anteriore e posteriore centre, front and rear channel	canale centrale o diffusori sonore di alta qualità. central speaker or high quality audio systems
Woofer	16,5 cm	16,5 cm	2x13 cm	2x13 cm
Tweeter	a cupola 2,5 cm orientabile dome 2.5 cm adjustable		2x2,5 cm orientabile 2x2.5 cm adjustable	2x2,5 cm orientabile 2x2.5 cm adjustable
Medio / Medium	---	---	8 cm	8 cm
Magnete tweeter / tweeter magnet	neodimio / neodymium	neodimio / neodymium	neodimio / neodymium	neodimio / neodymium
Membrana tweeter / tweeter diaphragm	seta e titanio silk and titanium	seta e titanio silk and titanium	seta e titanio silk and titanium	seta e titanio silk and titanium
Potenza RMS / musicale RMS / Music Power	80W/160W	50W/100W	120W/240W	120W/240W
Amplificazione consigliata Recommended amplification	da 10 a 100W RMS 10 to 100W RMS	---	da 10 a 150W RMS 10 to 100W RMS	da 10 a 150W RMS 10 to 100W RMS
Impedenza / Tensione trasformatore Impedance / Transformer voltage	4-8Ω selezionabile 4-8Ω selectable	attivo classe D D class active	4-8Ω selezionabile 4-8Ω selectable	4-8Ω selezionabile 4-8Ω selectable
Risposta in frequenza / Sensibilità Frequency Response / Sensitivity	45-22000Hz / 88dB	45-22000Hz / 88dB	45-22000Hz / 91dB	45-22000Hz / 91dB
Alimentazione / Power supply	---	AL5B not included	---	---
Dimensioni (LxHxP) / Size (WxHxD)	219x306x90 mm	219x306x90 mm	357x255x84 mm	357x255x84 mm
Foro da incasso (LxH) / Recessed hole (WxH)	190x275 mm	190x275 mm	330x225 mm	330x225 mm
Peso / Weight	1,9 kg	2,2 kg	5 kg	5 kg
Colore / Color	bianco / white RAL 9016	bianco / white RAL 9016	bianco / white RAL 9016	bianco / white RAL 9016
Cabinet	ABS V0 con griglia di protezione zincata verniciata / ABS V0 with painted galvanized grille			
Incasso su muratura / Recessed on masonry	SR2	SR2	SR3/SR3PLUS	SR3/SR3PLUS
Incasso su cartongesso Recessed on plasterboard	non servono accessori, il diffusore nel retro è dotato di ganci per l'ancoraggio stabile no accessories needed, the speaker is provided with hook shaped anchors for stable fixing in the rear			
Incasso a filo muro Recessed in the wall	SR2FM	SR2FM	SR3FM	---
Incasso a filo cartongesso Flush mounting plasterboard	SR2FC	SR2FC	SR3FC	---



## GIADA20F

**GIADA20F.R** (min 10pz, colore personalizzabile/ min 10 pcs custom color)

## GIADA20TF

**GIADA20TF.R** (min 10pz, colore personalizzabile/ min 10 pcs custom color)

## GIADA20AF

**GIADA20AF.R** (min 10pz, colore personalizzabile/ min 10 pcs custom color)

## GIADA20HPF

**GIADA20HPF.R** (min 10pz, colore personalizzabile/ min 10 pcs custom color)

## GIADA20HPFA

**GIADA20HPFA.R** (min 10pz, colore personalizzabile/ min 10 pcs custom color)

## GIADA213F

**GIADA213F.R** (min 10pz, colore personalizzabile/ min 10 pcs custom color)

### Campi applicativi Application fields



	GIADA20F	GIADA20TF	GIADA20AF	GIADA20HPF	GIADA20HPFA	GIADA213F
Descrizione / Description	Diffusore rettangolare da incasso, HiFi, Frameless / Recessed Rectangular speaker, HiFi, Frameless					Canale centrale per Home Cinema Central CH for Home Cinema
	2 vie /2 way	2 vie /2 way	2 vie /2 way	3 vie / 3 way	3 vie / 3 way	
Woofers	20,5 cm	20,5 cm	20,5 cm kevlar	20 cm	20 cm	2x13,5cm kevlar
Tweeter orientabile / adjustable	a cupola 3,2 cm dome 3,2 cm	a cupola 3,2 cm dome 3,2 cm	a cupola 3,2 cm dome 3,2 cm	a cupola 2,5 cm dome 2,5 cm	a cupola 2,5 cm dome 2,5 cm	a cupola 2,5 cm dome 2,5 cm
Medio	---	---	---	8cm kevlar	8cm kevlar	8 cm kevlar
Magnete tweeter / tweeter magnet	neodimio neodymium	neodimio neodymium	neodimio neodymium	neodimio neodymium	neodimio neodymium	neodimio neodymium
Membrana tweeter/ tweeter diaphragm	seta / silk	seta / silk	seta / silk	seta e titanio silk and titanium	seta e titanio silk and titanium	titanio / titanium
Potenza RMS / musicale RMS / Music Power	80W/160W	---	50W/100W	120W/240W	50W/100W	70W/140W
Potenza nominale / peak Nominal power / peak	---	3,75/7,5/15W 30W peak, max 105dB	---			---
Amplificazione consigliata Recommended amplification	da 10 a 100W RMS	---	---	da 10 a 150W RMS 10 to 150W RMS	---	da 10 a 80W RMS 10 to 80W RMS
Impedenza / Tensione trasformatore Impedance / Transformer voltage	8 Ω	100V	attivo / active	4-8 Ω selezionabile 4-8Ω selectable	attivo / active	8Ω
Risposta in frequenza / Sensibilità Frequency Response / Sensitivity	50-22000Hz/ 88dB	50-22000Hz/ 109dB	50-20000Hz/90dB	40-22000Hz/89dB	40-22000Hz/110dB	65-20000 Hz/90dB
Angolo di dispersione Dispersion angle	120° (V/O)	120° (V/O)	120° (V/O)	120° (V/O)	120° (V/O)	120° (V/O)
Alimentazione Power supply	---	---	tramite AL3B via AL3B	---	tramite AL3B via AL3B	---
Dimensioni (LxHxD) / Size (WxHxD)	242x362x105 mm	242x362x110 mm	242x362x125 mm	264x367x112 mm	264x367x112 mm	386x175x82 mm
Foro da incasso (LxH) Recessed hole (WxH)	220x340 mm	220x340 mm	220x340 mm	325x222 mm	325x222 mm	364x153 mm
Peso / Weight	1,9 kg	2 kg	2,2 kg	3,1 kg	3,4 kg	2 kg
Colore / Color	bianco / white RAL 9016					
Cabinet	ABS V0 con griglia di protezione zincata verniciata / ABS V0 with painted galvanized grille					
Incasso su muratura Recessed on masonry	SR3PLUS	SR3PLUS	SR3PLUS	SR3PLUS	SR3PLUS	SC2
Incasso su cartongesso Flush mounting plasterboard	non servono accessori, il diffusore nel retro è dotato di ganci per l'ancoraggio stabile no accessories needed, the speaker is provided with hook shaped anchors for stable fixing in the rear					

## GIADA20SPF



**GIADA20SPF.R** (min 10pz, colore personalizzabile/ min 10 pcs custom color)

**Campi applicativi**  
Application fields



**121dB**



## GIADA20SPF

Descrizione / Description	Diffusore rettangolare, 2 vie da incasso, SUPER POWER, HiFi, <b>frameless</b> Rectangular speaker, 2 way, SUPER POWER, recessed, HiFi, <b>frameless</b>
Altoparlante / Speaker	Coax
Magnete / Magnet	neodimio / neodymium
Cestello / Small basket	alluminio / aluminium
Woofers	20,5 cm
Driver	a compressione da 3,4 cm in titanio / 3.4 cm titanium compression
Potenza RMS / musicale RMS / Music Power	200W / 400W
Amplificazione consigliata Recommended amplification	da 150 a 300W RMS 150 to 300W RMS
Impedenza / Tensione trasformatore Impedance / Transformer voltage	8Ω
Risposta in frequenza / Sensibilità Frequency Response / Sensitivity	70-20000 Hz / 97 dB
Angolo di dispersione / Dispersion angle	100° (V/O)
Modalità di funzionamento Operation mode	- FULL RANGE risposta in frequenza 70-20000 Hz - Sensibilità 97dB - SAT risposta in frequenza 140-20000 Hz - Sensibilità 97dB - FULL RANGE frequency response 70-20000 Hz - Sensitivity 97dB - SAT frequency response 140-20000 Hz - Sensitivity 97dB
Dimensioni (LxHxP) / Size (WxHxD)	242x362x135 mm
Foro da incasso (LxH) / Recessed hole (LxH)	220x340 mm
Peso / Weight	2,9 kg
Colori / Color	bianco RAL 9016 / white RAL 9016
Cabinet	ABS V0 con griglia di protezione zincata verniciata / ABS V0 with painted galvanized grille
Incasso su muratura / Recessed on masonry	SR3PLUS
Incasso su cartongesso Recessed on plasterboard	non servono accessori, il diffusore nel retro è dotato di ganci per l'ancoraggio stabile no accessories needed, the speaker is provided with hook shaped anchors for stable fixing in the rear
Subwoofer consigliato Recommended subwoofer	- per utilizzi Pub SUB15A / -for Pub SUB15A use - per sistemi Home Cinema SMARTQUBEB / for SMARTQUBEB Home Cinema systems

## ROUND16F



**ROUND16F.R** (min 10pz, colore personalizzabile/ min 10 pcs custom color)

## ROUND16TF



**ROUND16TF.R** (min 10pz, colore personalizzabile/ min 10 pcs custom color)

## ROUND16AF



**ROUND16AF.R** (min 10pz, colore personalizzabile/ min 10 pcs custom color)

**RR16FB** retina black RAL9004 per ROUND16F/TF/AF

## ROUND17TF









**ROUND17TF.R** (min 10pz, colore personalizzabile/ min 10 pcs custom color)

### Campi applicativi Application fields



	ROUND16F	ROUND16TF	ROUND16AF	ROUND17TF
Descrizione / Description	Diffusore rotondo 2 vie, da incasso, HiFi, Frameless / 2 way round speaker, recessed, HiFi, Frameless			
Woofer	16,5 cm kevlar	16,5 cm kevlar	16,5 cm kevlar	16,5 cm
Tweeter orientabile / adjustable	a cupola 1,9 cm dome 1.9 cm	a cupola 1,9 cm dome 1.9 cm	a cupola 1,9 cm dome 1.9 cm	a cupola 1,9 cm dome 1.9 cm
Magnete / Magnet	neodimio / neodymium	neodimio / neodymium	neodimio / neodymium	neodimio / neodymium
Membrana / Diaphragm	seta / silk	seta / silk	seta / silk	mylar
Potenza RMS / musicale RMS / Music Power	60W/120W	---	50W/100W	---
Potenza nominale / peak Nominal power / peak	---	3,75/7,5/15W 30W peak, max 104dB	---	2/4/8/16/32W 64W peak, max 104dB
Amplificazione consigliata Recommended amplification	da 10 a 70W RMS 10 to 70W RMS	---	---	---
Impedenza / Tensione trasformatore Impedance / Transformer voltage	8Ω	100V	attivo / active	100V
Risposta in frequenza / Sensibilità Frequency Response / Sensitivity	60-20000Hz / 90dB	60-20000Hz / 89dB	60-20000Hz / 90dB	65-20000Hz -10dB / 86dB
Angolo di dispersione Dispersion angle	120° (V/O)	120° (V/O)	120° (V/O)	---
Alimentazione / Power supply	---	---	tramite AL3B (non incluso) via AL3B (not included)	---
Dimensioni (DxP) / Size (DxD)	227x87 mm	227x87 mm	227x97 mm	284x155 mm
Foro da incasso (D) Recessed hole (D)	205 mm	205 mm	205 mm	262 mm
Peso / Weight	1,5 kg	1,5 kg	1,7 kg	2,9 kg
Colore / Color	bianco RAL9016 white RAL9016	bianco RAL9016 white RAL9016	bianco RAL9016 white RAL9016	bianco RAL9016 white RAL9016
Cabinet	ABS V0 con griglia di protezione zincata verniciata / ABS V0 with painted galvanized grille			
Incasso su muratura Recessed on masonry	SR16	SR16	non adatto / not suitable	non adatto / not suitable
Incasso su cartongesso Recessed on plasterboard	non servono accessori, il diffusore nel retro è dotato di ganci per l'ancoraggio stabile no accessories needed, the speaker is provided with hook shaped anchors for stable fixing in the rear			

-  **ROUND20F**
-  **ROUND20F.R** (min 10pz, colore personalizzabile/ min 10 pcs custom color)
-  **ROUND20TF**
-  **ROUND20TF.R** (min 10pz, colore personalizzabile/ min 10 pcs custom color)
-  **ROUND20AF**
-  **ROUND20AF.R** (min 10pz, colore personalizzabile/ min 10 pcs custom color)

## Campi applicativi Application fields



	<b>ROUND20F</b>	<b>ROUND20TF</b>	<b>ROUND20AF</b>
Descrizione / Description	Diffusore rotondo, 2 vie da incasso, HiFi, <b>frameless</b> / Round speaker, 2 way recessed, HiFi, <b>frameless</b>		
Woofer	20,5 cm kevlar	20,5 cm kevlar	20,5 cm kevlar
Tweeter orientabile / adjustable	a cupola 1,9 cm / dome 1.9 cm	a cupola 1,9 cm / dome 1.9 cm	a cupola 1,9 cm / dome 1.9 cm
Magnete / Magnet	neodimio / neodymium	neodimio / neodymium	neodimio / neodymium
Membrana / Diaphragm	seta / silk	seta / silk	seta / silk
Potenza RMS / musicale RMS / Music Power	80W/160W	---	50W/100W
Potenza nominale / peak Nominal power / peak	---	2/4/8/16/32W 64W peak, max 108dB	---
Amplificazione consigliata Recommended amplification	da 10 a 90 W RMS 10 to 90W RMS	---	---
Impedenza / Tensione trasformatore Impedance / Transformer voltage	8Ω	100V	attivo / active
Risposta in frequenza / Sensibilità Frequency Response / Sensitivity	50-20000Hz/90dB	50-20000Hz +-3dB/89dB	50-20000Hz/90dB
Angolo di dispersione / Dispersion angle	120° (V/O)	120° (V/O)	120° (V/O)
Alimentazione / Power supply	---	---	AL3B not included
Dimensioni (DxP) / Size (DxD)	277x105 mm	283x109 mm	277x125mm
Foro da incasso (D) / Recessed hole (D)	258 mm	258 mm	258 mm
Peso / Weight	2,0 kg	2,0 kg	2,3 kg
Colore / Color	bianco RAL9016 / white RAL9016	bianco RAL9016 / white RAL9016	bianco RAL9016 / white RAL9016
Cabinet	ABS V0 con griglia di protezione zincata verniciata / ABS V0 with painted galvanized grille		
Incasso su muratura / Recessed on masonry	non adatto / not suitable	non adatto / not suitable	non adatto / not suitable
Incasso su cartongesso Recessed on plasterboard	non servono accessori, il diffusore nel retro è dotato di ganci per l'ancoraggio stabile no accessories needed, the speaker is provided with hook shaped anchors for stable fixing in the rear		





## ROUND20HPF

**ROUND20HPF.R** (min 10pz, colore personalizzabile/ min 10 pcs custom color)

### Campi applicativi Application fields



## ROUND20HPF frameless

Descrizione / Description	Diffusore TOP CLASS, rotondo, 3 vie da incasso a controsoffitto, HiFi TOP CLASS speaker, round, 3 way recessed false ceiling, HiFi
Woofer	20 cm
Tweeter orientabile / adjustable	a cupola 2,5 cm / dome 2.5 cm
Medio	8 cm
Magnete / Magnet	neodimio / neodymium
Membrana / Diaphragm	seta e titanio / silk and titanium
Potenza RMS / musicale RMS / Music Power	120W/240W
Amplificazione consigliata Recommended amplification	da 10 a 150W RMS 10 to 150W RMS
Impedenza / Tensione trasformatore Impedance / Transformer voltage	4-8Ω selezionabile 4-8Ω selectable
Risposta in frequenza / Sensibilità Frequency Response / Sensitivity	40-22000Hz / 89dB
Angolo di dispersione / Dispersion angle	120° (V/O)
Alimentazione / Power supply	---
Dimensioni (DxP) / Size (DxD)	273x127 mm
Foro da incasso (D) / Recessed hole (D)	250 mm
Peso / Weight	3 kg
Colore / Color	bianco RAL9016 / white RAL9016
Cabinet	ABS V0 con griglia di protezione zincata verniciata / ABS V0 with painted galvanized grille
Incasso su muratura / Recessed on masonry	non adatto / not suitable
Incasso su cartongesso Recessed on plasterboard	non servono accessori, il diffusore nel retro è dotato di ganci per l'ancoraggio stabile no accessories needed, the speaker is provided with hook shaped anchors for stable fixing in the rear



## ROUND20SPF

**ROUND20SPF.R** (min 10pz, colore personalizzabile/ min 10 pcs custom color)

Campi applicativi  
Application fields



121dB

## ROUND20SPF

Descrizione / Description	Diffusore rotondo, 2 vie da incasso, SUPER POWER, HiFi, <b>frameless</b> Round speaker, 2 way recessed, SUPER POWER, HiFi, <b>frameless</b>
Altoparlante / Speaker	Coax
Magnete / Magnet	neodimio / neodymium
Cestello / Drum	alluminio / aluminium
Woofers	20,5 cm
Driver	a compressione da 3,4 cm in titanio / 3.4 cm titanium compression
Potenza RMS / musicale RMS / Music Power	200W / 400W
Amplificazione consigliata Recommended amplification	da 150 a 300W RMS / 150 to 300W RMS
Impedenza / Tensione trasformatore Impedance / Transformer voltage	8Ω
Risposta in frequenza / Sensibilità Frequency Response / Sensitivity	70-20000Hz / 97 dB
Angolo di dispersione / Dispersion angle	100° (V/O)
Modalità di funzionamento Operation mode	- FULL RANGE risposta in frequenza 70-20000Hz - Sensibilità 97dB - SAT risposta in frequenza 140-20000Hz - Sensibilità 97dB - FULL RANGE frequency response 70-20000Hz - Sensitivity 97dB - SAT frequency response 140-20000Hz - Sensitivity 97dB
Dimensioni (DxD) / Size (DxD)	284x135 mm
Foro da incasso (D) / Recessed hole (D)	258 mm
Peso / Weight	2,8 kg
Colore / Color	bianco RAL 9016 / white RAL9016
Cabinet	ABS V0 con griglia di protezione zincata verniciata / ABS V0 with painted galvanized grille
Incasso su muratura Recessed on masonry	non adatto / not suitable
Incasso su cartongesso Recessed on plasterboard	non servono accessori, il diffusore nel retro è dotato di ganci per l'ancoraggio stabile no accessories needed, the speaker is provided with hook shaped anchors for stable fixing in the rear
Subwoofer consigliato	- per utilizzi Pub SUB15A e per sistemi Home Cinema SMARTQUBE - for Pub use SUB15A / for Home Cinema systems SMARTQUBE



# Retine personalizzate per arredare con semplicità

Customised grills for simple decoration



# OPERA



Codice / Code	OPERA
Modelli diffusori realizzabili Customized speakers	ROUND16 - ROUND20 GIADA16 - GIADA20 - GIADA213
Tipo di file File type	Tiff - JPEG - PNG
Risoluzione consigliata Recommended resolution	300 dpi
Quantità minimo ordinabile Moq	1pz
Elaborazione grafica Graphic processing	design@vivaldigroup.it



- IP56 **MARINE6**
- IP56 **MARINE6T**
- IP56 **MARINE7**
- IP56 **MARINE7T**

### Campi applicativi Application fields



MARINE6

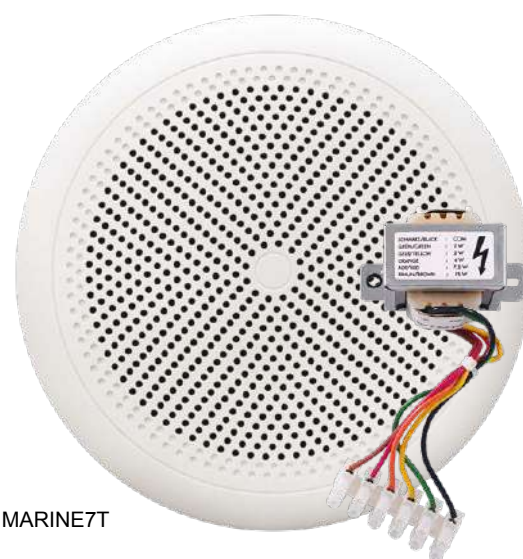

MARINE7T

	<b>MARINE6</b>	<b>MARINE6T</b>	<b>MARINE7</b>	<b>MARINE7T</b>
Descrizione / Description	Diffusore rotondo, 2 vie da incasso, HiFi resistente al cloro e alla salsedine Round speaker, 2 way built-in, HiFi resistant to chlorine and salt			
Grado di protezione / Protection degree	IP56	IP56	IP56	IP56
Woofers	13 cm	13 cm	16 cm	16 cm
Tweeter orientabile / adjustable	1,8 cm	1,8 cm	2 cm	2 cm
Potenza RMS / musicale RMS / Music Power	20W/35W	---	25W/45W	---
Potenza nominale / peak Nominal power / peak	---	3,75/7,5/15W RMS 30W peak, max 105dB	---	3,75/7,5/15W RMS 30W peak, max 105dB
Amplificazione consigliata Recommended amplification	da 10 a 30W RMS 10 to 30W RMS	---	da 10 a 35W RMS 10 to 35W RMS	---
Impedenza / Tensione trasformatore Impedance / Transformer voltage	8Ω	100V	8Ω	100V
Risposta in frequenza / Sensibilità Frequency Response / Sensitivity	95-20000Hz/90dB	95-20000Hz/90dB	85-20000Hz/90dB	85-20000Hz/90dB
Angolo di dispersione / Dispersion angle	120° (V/O)	120° (V/O)	120° (V/O)	120° (V/O)
Dimensioni (DxP) / Size (DxD)	165x75 mm	165x75 mm	190x90 mm	190x90 mm
Foro da incasso (D) / Recessed hole (D)	122 mm	122 mm	147 mm	147 mm
Peso / Weight	0,7 kg	0,7 kg	0,8 kg	0,8 kg
Colore / Color	bianco RAL9016 white RAL9016	bianco RAL9016 white RAL9016	bianco RAL9016 white RAL9016	bianco RAL9016 white RAL9016
Cabinet	ABS V0	ABS V0	ABS V0	ABS V0
Incasso su muratura Recessed on masonry	non adatto / not suitable	non adatto / not suitable	non adatto / not suitable	non adatto / not suitable
Incasso su cartongesso Recessed on plasterboard	non servono accessori / no accessories needed			

PLANA2  
 PLANA2T  
 PLANA2B  
 PLANA2TB

Campi applicativi  
 Application fields



	PLANA2	PLANA2T
Descrizione / Description	Diffusore rettangolare piatto, 2 vie da parete, HiFi / Flat rectangular speaker, 2 way wall, HiFi	
Woofers	13,5 cm	13,5 cm
Tweeter	1,3 cm mylar	1,3 cm mylar
Magnete / Magnet	ceramico / ceramic	ceramico / ceramic
Membrana / Diaphragm	carta trattata / treated paper	carta trattata / treated paper
Potenza RMS / musicale RMS / Music Power	30W/60W	8W 16W peak, max 97dB
Amplificazione consigliata Recommended amplification	da 10 a 40W RMS 10 to 40W RMS	---
Impedenza / Tensione trasformatore Impedance / Transformer voltage	8Ω	100V
Risposta in frequenza / Sensibilità Frequency Response / Sensitivity	80-20000Hz/85dB	70-20000Hz/85dB
Dimensioni (LxHxP) / Size (WxHxD)	185x275x40 mm	185x275x40 mm
Peso / Weight	0,9 kg	0,9 kg
Colore / Color	bianco RAL9016 / white RAL9016	bianco RAL9016 / white RAL9016
Cabinet	ABS V0 con griglia di protezione zincata verniciata / ABS V0 with painted galvanized grille	

- MINI8W** bianco / white
- IP44 MINI8W.IP**
- MINI8B** nero / black
- IP44 MINI8B.IP**
- LARA9TB** nero / black
- LARA9TW** bianco / white
- LARA10TB** nero / black
- LARA10TW** bianco / white

### Campi applicativi Application fields



	<b>MINI8</b>	<b>LARA9T</b>	<b>LARA10T</b>
Descrizione / Description	Diffusore, 2 vie HiFi con staffa da parete inclinabile speaker, 2 way HiFi with tilting wall bracket	Proiettore di suono con staffa per fissaggio da parete 2 vie HiFi, IP32 Sound projector with bracket for wall mounting 2 way HiFi, IP32	
Woofer	8 cm	10 cm	13,5 cm
Tweeter	1,3 cm	2,5 cm	2,5 cm
Membrana / Diaphragm	mylar	mylar	mylar
Potenza RMS / musicale RMS / Music Power	20W/40W	30W/60W	40W/80W
Potenza nominale / peak Nominal power / peak	1,5/3/6W 12W peak, max 96dB	1,25/2,5/5/10W 20W peak, max 104dB	2,5/5/10/20W 40W peak, max 109dB
Amplificazione consigliata Recommended amplification	da 10 a 30W RMS / 10 to 30W RMS	da 10 a 30W RMS / 10 to 30W RMS	da 10 a 40W RMS / 10 to 40W RMS
Impedenza / Tensione trasformatore Impedance / Transformer voltage	8Ω - 100V selezionabile / selectable	8Ω - 100V selezionabile / selectable	8Ω - 100V selezionabile / selectable
Risposta in frequenza / Sensibilità Frequency Response / Sensitivity	120-20000Hz/85dB	80-20000Hz -10dB/91dB	70-20000Hz - 10dB/92dB
Angolo di dispersione Dispersion angle	90° (V/O)	90°Vx90°O (120° fino a 3 KHz)	90°Vx90°O (120° fino a 3 KHz)
Dimensioni (LxHxP) senza staffa Size (WxHxD) without bracket	94x140x100 mm	151x215x130 mm	176x251x161 mm
Dimensioni (LxHxP) con staffa Size (WxHxD) with bracket	---	151x245x163 mm	176x286x190 mm
Peso / Weight	0,7 kg	1,9 kg	2,6 kg
Colore / Color	bianco RAL9003 / white RAL9003 nero RAL9005 / black RAL9005	bianco RAL9003 / white RAL9003 nero RAL9005 / black RAL9005	bianco RAL9003 / white RAL9003 nero RAL9005 / black RAL9005
Cabinet	ABS V0 con griglia di protezione zincata verniciata / ABS V0 with painted galvanized grille		

## Campi applicativi Application fields



**AMBRA9TB** nero / black

**AMBRA9TW** bianco / white

**AMBRA10TB** nero / black

**AMBRA10TW** bianco / white

**AMBRA16TB** nero / black

**AMBRA16TW** bianco / white

**AMBRA21TB** nero / black

**AMBRA21TW** bianco / white



	<b>AMBRA9T</b>	<b>AMBRA10T</b>	<b>AMBRA16T</b>	<b>AMBRA21T</b>
Descrizione / Description	Diffusore da parete con staffa per fissaggio a parete 2 vie HiFi Wall speaker with bracket for wall fixing 2 way HiFi			
Woofers	11 cm	14 cm	16,5 cm	20 cm
Tweeter	2,5 cm	2,5 cm	2,5 cm	a cupola 3,2 cm dome 3,2 cm
Membrana / Diaphragm	alluminio e seta aluminium and silk	alluminio e seta aluminium and silk	alluminio e seta aluminium and silk	alluminio e seta aluminium and silk
Potenza RMS / musicale RMS / Music Power	40W/80W	50W/100W	60W/120W	80W/160W
Potenza nominale / peak Nominal power / peak	5/10/20W 40W peak, max 106dB	10/20/40W 80W peak, max 108dB	10/20/40W 80W peak, max 111dB	5/10/20/40W 80W peak, max 111dB
Amplificazione consigliata Recommended amplification	da 10 a 50W RMS 10 to 50W RMS	da 10 a 60W RMS 10 to 60W RMS	da 10 a 80W RMS 10 to 80W RMS	da 10 a 120W RMS 10 to 120W RMS
Impedenza / Tensione trasformatore Impedance / Transformer voltage	8Ω - 100V selezionabile selectable	8Ω - 100V selezionabile selectable	8Ω - 100V selezionabile selectable	8Ω - 100V selezionabile selectable
Risposta in frequenza / Sensibilità Frequency Response / Sensitivity	60-20000Hz/89dB	55-20000Hz/91dB	50-20000Hz/92dB	60-20000Hz-10dB/92dB
Angolo di dispersione Dispersion angle	90°Vx90°O (120° fino a 3 KHz)	90°Vx90°O (120° fino a 3 KHz)	90°Vx90°O (120° fino a 3 KHz)	90°Vx90°O (120° fino a 3 KHz)
Dimensioni (LxHxD) senza staffa Size (WxHxD) without bracket	130x195x115 mm	170x240x147 mm	208x320x185 mm	287x409x250 mm
Dimensioni (LxHxD) con staffa Size (WxHxD) with bracket	130x215x130 mm	170x270x170 mm	208x334x200 mm	287x448x288 mm
Peso / Weight	1,5 kg	2,7 kg	4,3 kg	6,3 kg
Colore / Color	bianco / white RAL9003 nero / black RAL9005	bianco / white RAL9003 nero / black RAL9005	bianco / white RAL9003 nero / black RAL9005	bianco / white RAL9003 nero / black RAL9005
Cabinet	ABS V0 con griglia di protezione zincata verniciata / ABS V0 with painted galvanized grille			



- IP65 **FLORA10TB** nero / black
- IP65 **FLORA10TW** bianco / white
- IP65 **FLORA13TB** nero / black
- IP65 **FLORA13TW** bianco / white
- IP65 **FLORA16TB** nero / black
- IP65 **FLORA16TW** bianco / white
- IP65 **FLORA16SPB** nero / black
- IP65 **FLORA16SPW** bianco / white

## Campi applicativi Application fields



	FLORA10T	FLORA13T	FLORA16T	FLORA16SP
Descrizione / Description	Proiettore di suono professionale, 2 vie HiFi con staffa per fissaggio da parete Professional 2 way HiFi sound projector with bracket for wall mounting			
Grado di protezione / Protection degree	IP65	IP65	IP65	IP65
Rotazione staffa / Bracket rotation	3 posizioni (-30°, 0°, +30°) Basculante 180°O/180°V 3 positions (-30°, 0°, +30°) Tilting 180°W/180°V		90° verticale, 170° orizzontale adjustable 0-90° vertical, 0-170° horizontal	
Applicazioni / Applications	Ideale per applicazioni outdoor anche in aree marine. Resistente ad agenti corrosivi quali cloro e salsedine Ideal for outdoor applications even in marine areas. Resistant to corrosive agents such as chlorine and salt			
Certificato EN54 / EN54 Certificate	si / yes	si / yes	si / yes	---
Woofers	10,5 cm	13,5 cm	16,5 cm	16,5 cm
Tweeter	a cupola 2,5 cm / dome 2,5 cm	a cupola 2,5 cm / dome 2,5 cm	a cupola 2,5 cm / dome 2,5 cm	---
Membrana / Diaphragm	poliammide / polyamide	titanio / titanium	titanio / titanium	---
Altoparlante / Speaker	---	---	---	coax con magneti neodimio, cestello in alluminio coax with neodymium magnets, aluminum basket
Driver	---	---	---	da 3,4 cm a compressione in titanio 3.4 cm compression titanium
Potenza RMS / musicale RMS / Music Power	30W/60W	60W/120W	60W/120W	150W/300W
Potenza nominale / peak Nominal power / peak	5/10/20W 40W peak, max 105dB	2/4/8/16/32W 64W peak, max 105dB	4/8/16/32W 64W peak, max 108dB	---
Amplificazione consigliata Recommended amplification	da 10 a 50W RMS 10 to 54W RMS	da 10 a 80W RMS 10 to 80W RMS	da 10 a 80W RMS 10 to 80W RMS	da 80 a 200W RMS 80 to 200W RMS
Impedenza / Tensione trasformatore Impedance / Transformer voltage	8Ω - 100V selezionabile selectable	8Ω - 100V selezionabile selectable	8Ω - 100V selezionabile selectable	8Ω
Risposta in frequenza / Sensibilità Frequency Response / Sensitivity	75-20000Hz -10dB/85dB	65-20000Hz -10dB/87dB	60-20000Hz -10dB/90dB	90-20000 Hz/93dB
Angolo di dispersione / Dispersion angle	105°Vx90°O (120° fino a 3 KHz)	105°Vx90°O (120° fino a 3 KHz)	105°Vx90°O (120° fino a 3 KHz)	100° (V/O)
Dimensioni (LxHxP) senza staffa Size (WxHxD) without bracket	170x250x147 mm	186x257x165 mm	222x315x235 mm	222x315x235 mm
Dimensioni (LxHxP) con staffa Size (WxHxD) with bracket	170x243x180 mm	186x257x187 mm	222x335x295 mm	222x335x295 mm
Peso / Weight	2,4 kg	2,4 kg	3,0 kg	4,5 kg
Colore / Color	bianco RAL9003 / white RAL9003 nero RAL9005 / black RAL9005		bianco RAL9003 / white RAL9003 nero RAL9005 / black RAL9005	
Cabinet	ABS 5VB, con griglia di protezione in alluminio / ABS 5VB with aluminum grille			



IP66 **AIR30TB** nero / black

IP66 **AIR30TW** bianco / white

IP66 **AIR40TB** nero / black





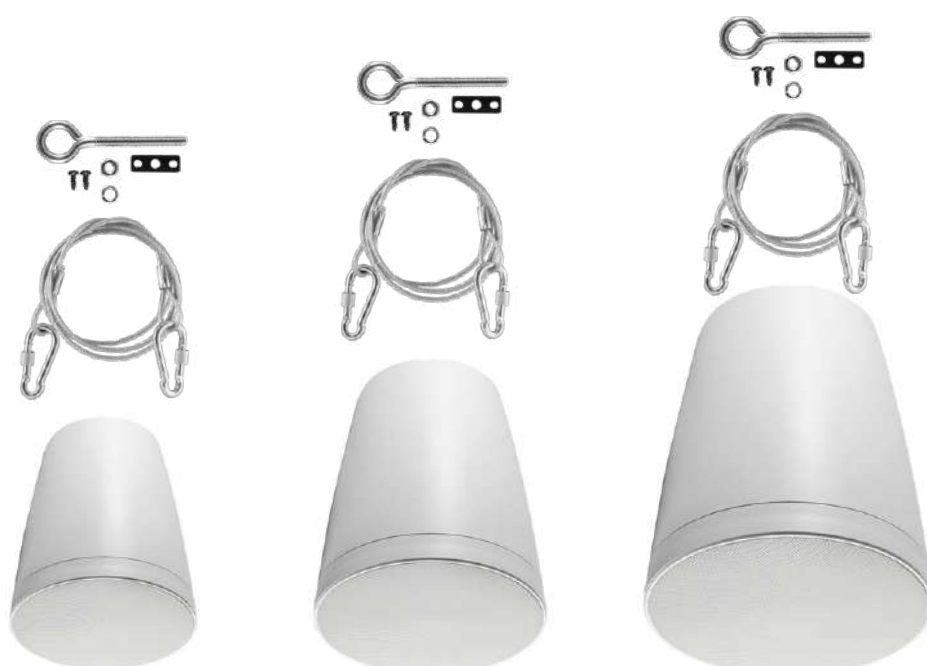

IP66 **AIR40TW** bianco / white

EN54-24 IP66 **AIR50TB** nero / black

EN54-24 IP66 **AIR50TW** bianco / white



	<b>AIR30T</b>	<b>AIR40</b>	<b>AIR50T</b>
Descrizione / Description	Diffusore da sospensione, 2 vie completo di passacavo e anello, IP66 Pendant speaker, 2 way, complete with cable gland and metal ring, IP66	Diffusore da sospensione, 2 vie completo di passacavo e anello, IP66 Pendant speaker, 2 way, complete with cable gland and metal ring, IP66	Diffusore da sospensione, 2 vie completo di passacavo e anello, IP66 Pendant speaker, 2 way, complete with cable gland and metal ring, IP66
Certificato EN54 / EN54 Certificate	no	no	si / yes
Woofers	13 cm	16,5 cm	20 cm
Tweeter	2,8 cm	2,8 cm	2,8 cm
Potenza RMS / musicale / RMS / Music Power	60W/120W	60W/120W	80W/160W
Potenza nominale 70V/100V / peak Nominal power 70V/100V / peak	3,7/7,5/1530W 60W peak, max 102dB	5/10/20/40W 80W peak, max 105dB	6,25/12,5/25/50W 100W peak, max 107dB
Impedenza / Tensione trasformatore Impedance / Transformer voltage	8Ω/70V/100V	8Ω/70V/100V	8Ω/70V/100V
Risposta in frequenza / Sensibilità Frequency Response / Sensitivity	80-20000 Hz -3dB / 84dB	51-20000 Hz -3dB / 85dB	44-20000Hz -10dB / 86dB
Angolo di dispersione / Dispersion angle	120° a cono / cone	120° a cono / cone	120° a cono / cone
Dimensioni (DxH) / Size (DxH)	190x250 mm	230x300 mm	270x343 mm
Lunghezza cavo / Cable length	110 cm	110 cm	110 cm
Peso / Weight	2,5 Kg	4 Kg	5,0 kg
Colore / Color	bianco RAL9010 / white RAL9010 nero RAL9005 / black RAL9005	bianco RAL9010 / white RAL9010 nero RAL9005 / black RAL9005	bianco RAL9010 / white RAL9010 nero RAL9005 / black RAL9005
Cabinet	ABS V0		

- IP66  **ANNA13TB** nero / black
- IP66  **ANNA13TW** bianco / white
- IP66  **ANNA16TB** nero / black
- IP66  **ANNA16TW** bianco / white
- IP66  **ANNA20TB** nero / black
- IP66  **ANNA20TW** bianco / white

### Campi applicativi Application fields



3 vie  
con subwoofer  
3 Way  
with subwoofer



	ANNA13T	ANNA16T	ANNA20T
Descrizione / Description	Proiettore di suono professionale, in versione Hi-Fi, 3 vie, con subwoofer, staffa per fissaggio a parete in dotazione Professional sound projector, Hi-Fi version, 3 way, with subwoofer, bracket for wall mounting included		
Grado di protezione / Protection degree	IP66	IP66	IP66
Applicazioni / Applications	Ideale per applicazioni outdoor anche in aree marine. Resistente ad agenti corrosivi quali cloro e salsedine Ideal for outdoor applications even in marine areas. Resistant to corrosive agents such as chlorine and salt		
Subwoofer passivo	ellittico convesso 10,5x15 cm (LxH) convex elliptical 10.5x15 cm (WxH)	ellittico convesso 12x18 cm (LxH) convex elliptical 12x18 cm (WxH)	ellittico convesso 16,5x23,5 cm (LxH) convex elliptical 16.5x23.5 cm (WxH)
Woofer	13 cm in polipropilene, finitura graffite 13 cm in polypropylene, graphite finish	16,5 cm in polipropilene, finitura graffite 16,5 cm in polypropylene, graphite finish	20,5 cm in polipropilene, finitura graffite 20,5 cm in polypropylene, graphite finish
Tweeter	2,5 cm a cupola, in neodimio e seta 2.5 cm domed, in neodymium and silk	2,5 cm a cupola, in neodimio e seta 2.5 cm domed, in neodymium and silk	2,8 cm a cupola, in neodimio e seta 2.8 cm domed, in neodymium and silk
Potenza RMS / musicale RMS / Music Power	60W/120W	80W/160W	80W/160W
Potenza nominale / peak Nominal power / peak	2,5/5/10/20W 40W peak, max 104dB	5/10/20/40W 80W peak, max 107dB	6,25/12,5/25/50W 100W peak, max 108dB
Amplificazione consigliata Recommended amplification	da 10 a 80W RMS / from 10 to 80W RMS		
Impedenza / Tensione trasformatore Impedance / Transformer voltage	8Ω - 100V selezionabile / selectable	8Ω - 100V selezionabile / selectable	8Ω - 100V selezionabile / selectable
Risposta in frequenza / Sensibilità Frequency Response / Sensitivity	55-20000Hz -85dB	50-20000Hz -86dB	45-20000Hz -87dB
Angolo di dispersione / Dispersion angle	105°Vx90°O (120° - 3 KHz) 105°Vx90°H (120° up to 3 KHz)	105°Vx90°O (120° - 3 KHz) 105°Vx90°H (120° up to 3 KHz)	105°Vx90°O (120° - 3 KHz) 105°Vx90°H (120° up to 3 KHz)
Dimensioni (LxHxP) senza staffa Size (WxHxD) without bracket	170x258x168 mm	198x285x195 mm	250x381x250 mm
Dimensioni (LxHxP) con staffa Size (WxHxD) with bracket	170x258x185 mm	198x285x215 mm	250x381x280 mm
Peso / Weight	2,76 kg	3,45 kg	5,01 kg
Colore / Color	bianco RAL9003 con bordi RAL7035 / white RAL9003 with edges RAL7035 nero RAL9005 / black RAL9005		
Cabinet	ABS, staffa e griglia in alluminio verniciato / ABS, bracket and aluminium grille painted		
Note	i diffusori della serie ANNA sono dotati di un altoparlante subwoofer passivo pertanto danno la miglior resa sulle basse frequenze installandoli a parete o ad angolo su soffitto / ANNA series speakers are equipped with a passive subwoofer therefore give the best performance on the bass frequencies by installing them on the wall or at an angle on the ceiling		

IP65 **CS10T**  
 IP65 **CS20T**  
 IP65 **CS40**  
 IP65 **CS40T**

**Campi applicativi**  
 Application fields



	<b>CS10T</b>	<b>CS20T</b>	<b>CS40</b>	<b>CS40T</b>
Descrizione / Description	Diffusore a colonna, di design e qualità sonora elevata. 2 vie HiFi con staffa per fissaggio a parete orientabile Column speaker, design and high sound quality. 2 way HiFi with bracket for wall mounting adjustable			
Grado di protezione / Protection degree	IP65	IP65	IP65	IP65
Applicazioni / Applications	Ideale per luoghi di culto, parcheggi all'aperto o interrati, ambienti umidi, esposizione alla pioggia, piscine. Ideal for places of worship, outdoor or underground parking, humid environments, exposure to rain, swimming pools.			
Certificato EN54 / EN54 Certificate	---	---	---	si / yes
Altoparlanti / Speakers	nr. 3 (2 woofer + 1 tweeter)	nr. 5 (4 woofer + 1 tweeter)	nr. 9 (8 woofer + 1 tweeter)	
Potenza RMS / musicale RMS / Music Power	10W/20W	20W/40W	160W/320W	---
Potenza nominale / peak Nominal power / peak	1,25/2,5/5/10W 20W peak, max 102dB	2,5/5/10/20W 40W peak, max 109dB	---	5/10/20/40W 80W peak, max 113dB
Impedenza / Tensione trasformatore Impedance / Transformer voltage	8Ω/100V	8Ω/100V	4Ω	100V
Risposta in frequenza / Sensibilità Frequency Response / Sensitivity	130-20000Hz/89dB/106dB	110-20000Hz/92dB/110dB	100-20000Hz/94dB/114dB	100-20000Hz/94dB/114dB
Angolo di dispersione/ Dispersion angle	70°(V)x100°(O)	45°(V)x100°(O)	45°(V)x100°(O)	45°(V)x100°(O)
Dimensioni (LxHxP) senza staffa Size (WxHxD) without bracket	121x380x109 mm	121x570x109 mm	121x950x109 mm	121x950x109 mm
Peso / Weight	3,6 kg	5,2 kg	7,5 kg	7,5 kg
Colore / Color	bianco RAL9003 white RAL9003	bianco RAL9003 white RAL9003	bianco RAL9003 white RAL9003	bianco RAL9003 white RAL9003
Cabinet	alluminio verniciato con griglia di protezione zincata verniciata / aluminium with painted galvanized grill			





**IP65 PH208TPRO**



**IP65 PH210TPRO**

**IP55 PH212TPRO**

**ST212** supporto da soffitto per PH212TPRO / ceiling mount for PH212TPRO

**IP55 PH50HIFI**

**Campi applicativi**  
Application fields



**PH208TPRO**

**PH210TPRO**

**PH212TPRO**

**PH50HIFI**

	<b>PH208TPRO</b>	<b>PH210TPRO</b>	<b>PH212TPRO</b>	<b>PH50HIFI</b>
Descrizione / Description	Diffusore a tromba 2 vie professionale a tenuta stagna per amplificazioni a lunga gittata resistente ai raggi UV Professional watertight 2 way loudspeaker, waterproof, for long-range amplification resistant to UV rays			
Grado di protezione / Protection degree	IP65	IP65	IP55	IP65
Applicazioni / Applications	ideale per stadi, palazzetti dello sport, piazze... ideal for stadiums, sports halls, squares...			
Potenza RMS / musicale RMS / Music Power	180W/360W	250W/500W	250W/500W	-
Potenza nominale / peak Nominal power / peak	15/30/60/120W 240W peak	25/50/100/200W 400W peak	250W 500W peak	15/30/50W 100W peak, max 118dB
Impedenza / Tensione trasformatore Impedance / Transformer voltage	8Ω/100V	8Ω/100V	8Ω/100V	100V
Risposta in frequenza / Sensibilità Frequency Response / Sensitivity	80-18000 Hz +/-10dB 98dB	80-18000Hz +/-10dB 96 dB - SPL max @200W: 118 dB	70-18000Hz +/-10dB 102dB	100-16000Hz 10dB 101dB
Angolo di dispersione / Dispersion angle	60° (V/O) 1KHz - 45° (V/O) 5KHz	60° (V/O) 1KHz - 45° (V/O) 5KHz	60° (V/O) 1KHz - 45° (V/O) 5KHz	100°(V) 60°(O) 2KHz
Dimensioni (LxHxP) / Size (WxHxD)	300x302x334 mm con staffa / with bracket	355x355x360 mm con staffa / with bracket	450x450x670 mm	356x268x-312x294 mm con staffa / with bracket
Peso / Weight	10 kg	13,5 kg	28,5 kg	3,9 kg
Colore / Color	bianco / white RAL7035	bianco / white RAL7035	bianco / white RAL7016	bianco / white RAL7035
Cabinet	ABS V0 con griglia di protezione zincata verniciata ABS V0 with painted galvanized grille	ABS V0 con griglia di protezione zincata verniciata ABS V0 with painted galvanized grille	metallico verniciato grigio, tromba ABS con griglia di protezione zincata verniciata grey metal, ABS horn with painted galvanized grille	ABS V0 con staffa ad U in acciaio inox verniciato ABS V0, U-bracket in pain- ted stainless steel
Note	fornito con staffa included with bracket	fornito con staffa included with bracket	adatte per staffaggio a vite catena metallica con moschettone suitable for screw clamping metal chain with carabiner	rettangolare in ABS V0 rectangular ABS V0

IP56 **ROCK20T**

IP56 **GREEN16T**

Campi applicativi  
Application fields



	<b>ROCK20T</b>	<b>GREEN16T</b>
Descrizione / Description	Diffusore 2 vie coax, HiFi, da giardino waterproof / 2 way coax speaker, HiFi, waterproof garden	
Grado di protezione / Protection degree	IP56	IP56
Woofer	20 cm in polipropilene 20 cm polypropylene	16,5 cm in polipropilene 16.5 cm polypropylene
Tweeter	2,5 cm in titanio con magnete al neodimio 2.5 cm in titanium with neodymium magnet	3 cm in titanio magnete al neodimio 3 cm in titanium with neodymium magnet
Potenza RMS / musicale RMS / Music Power	75/150W	60/120W
Potenza nominale 100V / peak Nominal power 100V / peak	2/4/8/16/32W 64 peak, max 106dB	2/4/8/16/32W 64 peak, max 105dB
Potenza nominale 70V / peak Nominal power 70V / peak	2/4/8/16/32W 64W peak	2/4/8/16/32W 64W peak
Impedenza / Tensione trasformatore Impedance / Transformer voltage	8Ω/70V/100V	8Ω/70V/100V
Amplificazione consigliata Recommended amplification	da 10 a 100W RMS 10 to 100W RMS	da 10 a 100W RMS 10 to 100W RMS
Risposta in frequenza / Sensibilità Frequency Response / Sensitivity	50-20000Hz/91dB max 106dB	55-20000Hz/90dB max 105dB
Angolo di dispersione / Dispersion angle	120°(O)x120°(V)	360°(O)x40°(V)
Dimensioni Size	(LxHxP) 440x300x300 mm (WxHxD) 440x300x300 mm	(DxP) 365x409 mm (DxD) 365x409 mm
Peso / Weight	7,0 kg	3,0 kg
Colore / Color	grigio simil roccia / rock-like grey	verde / green
Cabinet	fibra di vetro verniciata / painted fiberglass	polipropilene UV / UV polypropylene

VIVALDI



# Hand Made

speakers  
with style



- IP65 **ZEN315**
- IP65 **ZEN315T**
- IP65 **ZEN510**
- IP65 **ZEN510T**

**Campi applicativi**  
Application fields



	ZEN315	ZEN315T	ZEN510	ZEN510T
Descrizione / Description	Diffusore di design, HiFi, 2 vie / Design speaker, HiFi, 2 way			
Grado di protezione / Protection degree	IP65	IP65	IP65	IP65
Tipologia / Typology	audio	audio	audio + luce / audio + light	audio + luce / audio + light
Applicazioni / Applications	terrazze, giardini, piscine... / terraces, gardens, swimming pools...			
Led	---	---	66 Led, 13,8W, 1380lm, 3800K	66 Led, 13,8W, 1380lm, 3800K
Woofer	16,5 cm	16,5 cm	16,5 cm	16,5 cm
Tweeter	2,5 cm	2,5 cm	2,5 cm	2,5 cm
Potenza RMS / musicale RMS / Music Power	50W/100W	---	50W/100W	---
Potenza nominale / peak Nominal power / peak	---	50W/100W	---	50W/100W
Impedenza / Tensione trasformatore Impedance / Transformer voltage	8Ω	100V	8Ω	100V
Risposta in frequenza / Sensibilità Frequency Response / Sensitivity	60-20000Hz/89dB	60-20000Hz/89dB	60-20000Hz/89dB	60-20000Hz/89dB
Dimensioni (DxH) / Size (DxH)	205x315 mm	205x315 mm	205x510 mm	205x510 mm
Flangia di ancoraggio (D) Anchor flange (D)	30 cm	30 cm	30 cm	30 cm
Peso / Weight	7,0 kg	7,0 kg	8,2 kg	8,2 kg
Colore / Color	acciaio spazzolato brushed steel	acciaio spazzolato brushed steel	acciaio spazzolato brushed steel	acciaio spazzolato brushed steel
Cabinet	acciaio Inox 316L stainless steel 316L	acciaio Inox 316L stainless steel 316L	acciaio Inox 316L stainless steel 316L	acciaio Inox 316L stainless steel 316L
Personalizzazione / Customization	colore su richiesta color on request	colore su richiesta color on request	colore su richiesta color on request	colore su richiesta color on request

IP65 **ZEN730**  
 IP65 **ZEN730T**  
 IP65 **ZEN780**  
 IP65 **ZEN780A**

Campi applicativi  
 Application fields



esempio di personalizzazione  
 nero opaco RAL 9005  
 example of customization  
 black matt RAL 9005



	<b>ZEN730</b>	<b>ZEN730T</b>	<b>ZEN780</b>	<b>ZEN780A</b>
Descrizione / Description	Diffusore di design, HiFi, 2 vie / Design speaker, HiFi, 2 way		Diffusore di design, HiFi, 3 vie / Design speaker, HiFi, 3 way	
Grado di protezione / Protection degree	IP65	IP65	IP65	IP65
Tipologia / Typology	audio	audio	audio + subwoofer	audio + subwoofer
Applicazioni / Applications	terrazze, giardini, piscine... / terraces, gardens, swimming pools...			
Subwoofer	---	---	2x16,5 cm push-pull	2x16,5 cm push-pull
Woofers	16,5 cm	16,5 cm	16,5 cm	16,5 cm
Tweeter	2,5 cm compressione 2,5 cm compression	2,5 cm compressione 2,5 cm compression	3,4 cm compressione 3,4 cm compression	3,4 cm compressione 3,4 cm compression
Potenza RMS / musicale RMS / Music Power	100/200W	---	300/600W	---
Potenza nominale / peak Nominal power / peak	---	50/100W	---	---
Potenza / power woofer RMS Potenza / power medio RMS Potenza / power tweeter RMS	---	---	---	300W 150W 150W
Impedenza / Tensione trasformatore Impedance / Transformer voltage	8Ω	100V	4Ω	attivo / active
Risposta in frequenza / Sensibilità Frequency Response / Sensitivity	60-20000Hz / 90dB	60-20000Hz / 90dB	40-20000Hz / 91dB	40-20000Hz / 1V RMS
Max output level full power	---	---	114dB	114dB
Alimentazione / Power supply	---	---	---	220V/50-60Hz
Dimensioni (DxH) / Size (DxH)	205x725 mm	205x725 mm	205x995 mm	205x995 mm
Flangia di ancoraggio (D) Anchor flange (D)	30 cm	30 cm	30 cm	30 cm
Peso / Weight	12,5 kg	12,5 kg	19,5 kg	19,5 kg
Colore / Color	acciaio spazzolato brushed steel	acciaio spazzolato brushed steel	acciaio spazzolato brushed steel	acciaio spazzolato brushed steel
Cabinet	acciaio Inox 316L spazzolato stainless steel 316L	acciaio Inox 316L spazzolato stainless steel 316L	acciaio Inox 316L spazzolato stainless steel 316L	acciaio Inox 316L spazzolato stainless steel 316L
Personalizzazione / Customization	colore su richiesta color on request	colore su richiesta color on request	colore su richiesta color on request	colore su richiesta color on request

- IP65 **ZEN930**
- IP65 **ZEN930T**
- IP65 **ZEN980**
- IP65 **ZEN980A**
-  IP65 **SUPERZEN**

**Campi applicativi**  
Application fields



esempio di personalizzazione  
nero opaco RAL 9005  
example of customization  
black matt RAL 9005



**114dB**

**126dB**

	<b>ZEN930</b>	<b>ZEN930T</b>	<b>ZEN980</b>	<b>ZEN980A</b>	<b>SUPERZEN</b>
Descrizione / Description	Diffusore di design, HiFi, 2 vie Design speaker, HiFi, 2 way	Diffusore di design, HiFi, 2 vie Design speaker, HiFi, 2 way	Diffusore di design, HiFi, 3 vie Design speaker, HiFi, 3 way	Diffusore di design, HiFi, 3 vie con DSP Design speaker, HiFi, 3 way with DSP	Diffusore di design, HiFi, 3 vie con DSP Design speaker, HiFi, 3 way with DSP
Grado di protezione / Protection degree	IP65	IP65	IP65	IP65	IP65
Tipologia / Typology	audio + luce / audio + light		audio + subwoofer + luce (light)		audio + subwoofer
Applicazioni / Applications	terrazze, giardini, piscine... / terraces, gardens, swimming pools...				
Led	66 Led, 13,8W, 1380lm, 3800K		66 Led, 13,8W, 1380lm, 3800K		---
Subwoofer	---	---	2x16,5 cm push-pull	2x16,5 cm push-pull	2x26,5 cm push-pull
Woofers	16,5 cm	16,5 cm	16,5 cm	16,5 cm	26,8 cm
Tweeter	2,5 cm compressione compression	2,5 cm compressione compression	3,4 cm compressione compression	3,4 cm compressione compression	4,4 cm compressione compression
Potenza RMS / musicale RMS / Music Power	100/200W	---	300/600W	---	3000/6000W
Potenza nominale / peak Nominal power / peak	---	50W 100W peak	---	---	---
Potenza / power woofer RMS Potenza / power medio RMS Potenza / power tweeter RMS	---	---	---	300W 150W 150W	2000W 600W 100W
Impedenza / Tensione trasformatore Impedance / Transformer voltage	8Ω	100V	4Ω	attivo / active	attivo / active
Risposta in frequenza / Sensibilità Frequency Response / Sensitivity	60-20000Hz / 90dB	60-20000Hz / 90dB	40-20000Hz / 91dB	40-20000Hz 1V RMS	40-20000Hz 1V RMS
Max output level full power	---	---	114dB	114dB	126dB
Alimentazione / Power supply	---	---	---	220V/50-60Hz	220V/50-60Hz
Dimensioni (DxH) / Size (DxH)	205x938 mm	205x938 mm	205x1200 mm	205x1200 mm	306x1220 mm
Flangia di ancoraggio / Anchor flange (D)	30 cm	30 cm	30 cm	30 cm	40 cm
Peso / Weight	14,2 kg	14,2 kg	20 kg	20 kg	46 kg
Colore / Color	acciaio spazzolato brushed steel	acciaio spazzolato brushed steel	acciaio spazzolato brushed steel	acciaio spazzolato brushed steel	acciaio spazzolato brushed steel
Cabinet	acciaio Inox 316L stainless steel 316L	acciaio Inox 316L stainless steel 316L	acciaio Inox 316L stainless steel 316L	acciaio Inox 316L stainless steel 316L	acciaio Inox 316L stainless steel 316L
Personalizzazione / Customization	colore su richiesta color on request	colore su richiesta color on request	colore su richiesta color on request	colore su richiesta color on request	colore su richiesta color on request



IP65 ZEN315L

IP65 ZEN730L



	ZEN315L	ZEN730L
Descrizione / Description	Lampada di design con illuminazione a LED per esterni / design lamp with outdoor LED lighting	
Grado di protezione / Protection degree	IP65	IP65
Applicazioni / Applications	terrazze, giardini, piscine... / terraces, gardens, swimming pools...	
Tecnologia / Technology	LED	LED
Punti led / LED points	66	66
Watt	13,8	13,8
Lumen	1380	1380
Temperatura / Temperature	3800K	3800K
Alimentazione / Power supply	240Vca	240Vca
Dispersione / Dispersion	360°	360°
Dimensioni (DxH) / Size (DxH)	205x315 mm	205x730 mm
Flangia di ancoraggio / Anchor flange (D)	30 cm	30 cm
Peso / Weight	4,0 kg	7,0 kg
Colore / Color	opalino / opaline	opalino / opaline
Personalizzazione / Customization	è possibile personalizzare il colore dei LED ed integrarne la gestione da iCONTROL4.1L, iCONTROL4.0+ it is possible to customize the color of the LEDs and integrate their management from iCONTROL4.1L, iCONTROL4.0+	



**KEOPE.S40**  
**KEOPE.S80**  
**KEOPE.S160**

**Campi applicativi**  
**Application fields**



	<b>KEOPE.S40</b>	<b>KEOPE.S80</b>	<b>KEOPE.S160</b>
Descrizione / Description	Diffusore TOP QUALITY, di design, 2 vie, da appoggio / TOP QUALITY speaker, design, 2 way, bookshelf		
Applicazioni / Applications	Ideale per sale cineconferenze, congressi, HiFi, Home Cinema e diffusionsi sonore Ideal for cine conference rooms, congresses, HiFi, Home Cinema and sound diffusion		
Woofers	9 cm	2x9 cm	4x9 cm
Tweeter	2,5 cm	2,5 cm	2,5 cm
Potenza RMS / musicale RMS / Music Power	45W/90W	85W/170W	165W/330W
Impedenza / Impedance	8Ω	4Ω	8Ω
Risposta in frequenza / Sensibilità Frequency Response / Sensitivity	85-20000Hz +-5dB/86dB	85-20000Hz +-5dB/89dB	85-20000Hz +-5dB/92dB
Dimensioni (LxHxP) / Size (WxHxD)	110x235x130 mm	110x450x130 mm	110x1110x130 mm
Peso / Weight	2,4 kg	3,5 kg	7,5 kg
Cabinet	legno / wood	legno / wood	legno / wood
Finiture / Finishing	alluminio spazzolato brushed aluminium	alluminio spazzolato brushed aluminium	alluminio spazzolato brushed aluminium
Supporto / Support	supporto per il fissaggio a parete, fornito in dotazione / support for wall mounting, included		
Calza colore di serie / Sock color as standard	nero / black	nero / black	nero / black
Colori calze Socks colors	<ul style="list-style-type: none"> <li>- bianco / white (K40W)</li> <li>- grigio / grey (K40G)</li> <li>- antracite / anthracite (K40A)</li> <li>- sabbia / sand (K40S)</li> <li>- ruggine / rust (K40R)</li> <li>- rosso ciliegia / red cherry (K40C)</li> <li>- glicine / wisteria (K40V)</li> <li>- blu ceruleo / cerulean blue (K40B)</li> <li>- verde / green (K40E)</li> </ul>	<ul style="list-style-type: none"> <li>- bianco / white (K80W)</li> <li>- grigio / grey (K80G)</li> <li>- antracite / anthracite (K80A)</li> <li>- sabbia / sand (K80S)</li> <li>- ruggine / rust (K80R)</li> <li>- rosso ciliegia / red cherry (K80C)</li> <li>- glicine / wisteria (K80V)</li> <li>- blu ceruleo / cerulean blue (K80B)</li> <li>- verde / green (K80E)</li> </ul>	<ul style="list-style-type: none"> <li>- bianco / white (K160W)</li> <li>- grigio / grey (K160G)</li> <li>- antracite / anthracite (K160A)</li> <li>- sabbia / sand (K160S)</li> <li>- ruggine / rust (K160R)</li> <li>- rosso ciliegia / red cherry (K160C)</li> <li>- glicine / wisteria (K160V)</li> <li>- blu ceruleo / cerulean blue (K160B)</li> <li>- verde / green (K160E)</li> </ul>

**KEOPE.HP60**  
**KEOPE.HP120**  
**KEOPE.M250** (monitor)

**Campi applicativi**  
**Application fields**



	<b>KEOPE.HP60</b>	<b>KEOPE.HP120</b>	<b>KEOPE.M250</b> (monitor)
Descrizione / Description	Diffusore TOP DI GAMMA, di design, 2 vie, da appoggio / FLAGSHIP speaker, design, 2 way, bookshelf		
Applicazioni Applications	Ideale per Sale Cineconferenze, congressi, HiFi, Home Cinema, diffusioni sonore, PUB, Birrerie ideal for Cine conference room, congress, HiFi, Home Cinema, sound system, PUB, Brewerie		
Woofer	13 cm	2x13 cm	2x15 cm
Tweeter	2,5 cm	2,5 cm	2,5 cm
Potenza RMS / musicale RMS / Music Power	70W/140W	120W/240W	240W/480W
Impedenza / Impedance	8Ω	4Ω	4Ω
Risposta in frequenza / Sensibilità Frequency Response / Sensitivity	65-20000Hz +5dB/89dB	65-20000Hz +5dB/92dB	45-20000Hz +5dB/90dB
Dimensioni (LxHxP) / Size (WxHxD)	172x275x210 mm	172x515x210 mm	172x1015x210 mm
Peso / Weight	6,0 kg	8,5 kg	13 kg
Cabinet	legno / wood	legno / wood	legno / wood
Finiture	alluminio spazzolato brushed aluminium	alluminio spazzolato brushed aluminium	alluminio spazzolato brushed aluminium
Supporto / Support	supporto per il fissaggio a parete, fornito in dotazione / support for wall mounting, included		
Calza colore di serie / Sock color as standard	nero / black	nero / black	nero / black
Colori calze	<ul style="list-style-type: none"> <li>- bianco / white (KHP60W)</li> <li>- grigio / grey (KHP60G)</li> <li>- antracite / anthracite (KHP60A)</li> <li>- sabbia / sand (KHP60S)</li> <li>- ruggine / rust (KHP60R)</li> <li>- rosso ciliegia / red cherry (KHP60C)</li> <li>- glicine / wisteria (KHP60V)</li> <li>- blu ceruleo / cerulean blue (KHP60B)</li> <li>- verde / green (KHP60E)</li> </ul>	<ul style="list-style-type: none"> <li>- bianco / white (KHP120W)</li> <li>- grigio / grey (KHP120G)</li> <li>- antracite / anthracite (KHP120A)</li> <li>- sabbia / sand (KHP120S)</li> <li>- ruggine / rust (KHP120R)</li> <li>- rosso ciliegia / red cherry (KHP120C)</li> <li>- glicine / wisteria (KHP120V)</li> <li>- blu ceruleo / cerulean blue (KHP120B)</li> <li>- verde / green (KHP120E)</li> </ul>	<ul style="list-style-type: none"> <li>- bianco / white (KM250W)</li> <li>- grigio / grey (KM250G)</li> <li>- antracite / anthracite (KM250A)</li> <li>- sabbia / sand (KM250S)</li> <li>- ruggine / rust (KM250R)</li> <li>- rosso ciliegia / red cherry (KM250C)</li> <li>- glicine / wisteria (KM250V)</li> <li>- blu ceruleo / cerulean blue (KM250B)</li> <li>- verde / green (KM250E)</li> </ul>

**KEOPE.SOUNDB80**  
**KEOPE.SOUNDB160**

**Campi applicativi**  
Application fields



KEOPE.SOUNDB80

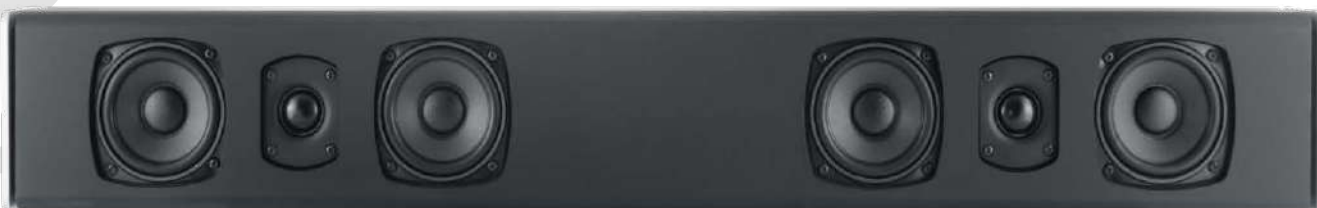

KEOPE.SOUNDB160

	<b>KEOPE.SOUNDB80</b>	<b>KEOPE.SOUNDB160</b>
Descrizione / Description	Soundbar stereo, di design, da appoggio / Stereo soundbar, design, bookshelf	
Applicazioni / Applications	Ideale per sistemi 2.1 in abbinamento ai subwoofer attivi SUB8A, SUB12A Ideal for 2.1 systems in combination with SUB8A, SUB12A active subwoofers	
Woofers	2x9 cm	4x9 cm
Tweeter	2x2,5 cm	2x2,5 cm
Potenza RMS / musicale RMS / Music Power	45+45W/90+90W	85+85W/170+170W
Impedenza / Impedance	8Ω	4Ω
Risposta in frequenza / Sensibilità Frequency Response / Sensitivity	85-20000Hz +-5dB/89dB	85-20000Hz +-5dB/92dB
Dimensioni (LxHxD) Size (WxHxD)	615x110x130 mm	915x110x130 mm
Peso / Weight	2,4 kg	6,8 kg
Cabinet	legno / wood	legno / wood
Finiture / Finishing	alluminio spazzolato / brushed aluminium	alluminio spazzolato / brushed aluminium
Supporto / Support	supporto per il fissaggio a parete, fornito in dotazione / support for wall mounting, included	
Calza colore di serie / Sock color as standard	nero / black	nero / black
Colori calze	<ul style="list-style-type: none"> <li>- bianco / white (KSB80W)</li> <li>- grigio / grey (KSB80G)</li> <li>- antracite / anthracite (KSB80A)</li> <li>- sabbia / sand (KSB80S)</li> <li>- ruggine / rust (KSB80R)</li> <li>- rosso ciliegia / red cherry (KSB80C)</li> <li>- glicine / wisteria (KSB80V)</li> <li>- blu ceruleo / cerulean blue (KSB80B)</li> <li>- verde / green (KSB80E)</li> </ul>	<ul style="list-style-type: none"> <li>- bianco / white (KSB160W)</li> <li>- grigio / grey (KSB160G)</li> <li>- antracite / anthracite (KSB160A)</li> <li>- sabbia / sand (KSB160S)</li> <li>- ruggine / rust (KSB160R)</li> <li>- rosso ciliegia / red cherry (KSB160C)</li> <li>- glicine / wisteria (KSB160V)</li> <li>- blu ceruleo / cerulean blue (KSB160B)</li> <li>- verde / green (KSB160E)</li> </ul>



## WB1

Supporto universale da parete.  
Inclinazione 120°V / 180°O.  
Portata 15Kg. Materiale lega di zinco, verniciato.  
Dimensioni (LxHxP) 9,5x11,5x5 cm. Peso 0,3Kg. Colore nero.

In-wall bracket for KEOPE speaker.  
Inclination: 120°V / 180°O.  
Capacity: 15Kg.  
Material: painted zinc alloy  
Size: (WxHxP) 95x115x50 mm.  
Weight: 0,3Kg. Colour: Black



## WB2

Supporto universale da parete.  
Inclinazione 30°V / 160°O.  
Portata 35Kg.  
Materiale acciaio, verniciato.  
Dimensioni (LxHxP) 6x12,5x12,5 cm. Peso 0,4Kg. Colore nero.

In-wall bracket for KEOPE speaker.  
Inclination: 30°V / 160°O.  
Capacity: 35Kg.  
Material: painted steel  
Size: (WxHxP) 60x125x125 mm.  
Weight: 0,4Kg. Colour: Black



## WB3

Supporto universale da parete.  
Inclinazione 120°V / 180°O.  
Portata 60Kg.  
Materiale acciaio, verniciato.  
Dimensioni (LxHxP) 9x16x10 cm. Peso 0,45Kg. Colore nero.

In-wall bracket for KEOPE speaker.  
Inclination: 120°V / 180°O.  
Capacity: 60Kg.  
Material: painted steel  
Size: (WxHxP) 90x160x100 mm  
Weight: 0,45Kg. Colour: Black





# SKINS

calze colorate opzionali  
optional coloured covers



## BLU CERULEO / CERULEAN BLUE

- K40B** per KEOPE.S40
- K80B** per KEOPE.S80
- K160B** per KEOPE.S160
- KSB80B** per KEOPE.SOUNDB80
- KSB160B** per KEOPE.SOUNDB160
- KHP60B** per KEOPE.HP60
- KHP120B** per KEOPE.HP120
- KM250B** per KEOPE.M250

## SABBIA / SAND

- K40S** per KEOPE.S40
- K80S** per KEOPE.S80
- K160S** per KEOPE.S160
- KSB80S** per KEOPE.SOUNDB80
- KSB160S** per KEOPE.SOUNDB160
- KHP60S** per KEOPE.HP60
- KHP120S** per KEOPE.HP120
- KM250S** per KEOPE.M250

## ANTRACITE / ANTHRACITE

- K40A** per KEOPE.S40
- K80A** per KEOPE.S80
- K160A** per KEOPE.S160
- KSB80A** per KEOPE.SOUNDB80
- KSB160A** per KEOPE.SOUNDB160
- KHP60A** per KEOPE.HP60
- KHP120A** per KEOPE.HP120
- KM250A** per KEOPE.M250

## GRIGIO / GREY

- K40G** per KEOPE.S40
- K80G** per KEOPE.S80
- K160G** per KEOPE.S160
- KSB80G** per KEOPE.SOUNDB80
- KSB160G** per KEOPE.SOUNDB160
- KHP60G** per KEOPE.HP60
- KHP120G** per KEOPE.HP120
- KM250G** per KEOPE.M250



## ROSSO CILIEGIA / RED CHERRY

**K40C** per KEOPE.S40  
**K80C** per KEOPE.S80  
**K160C** per KEOPE.S160  
**KSB80C** per KEOPE.SOUNDB80  
**KSB160C** per KEOPE.SOUNDB160  
**KHP60C** per KEOPE.HP60  
**KHP120C** per KEOPE.HP120  
**KM250C** per KEOPE.M250



## VERDE / GREEN

**K40E** per KEOPE.S40  
**K80E** per KEOPE.S80  
**K160E** per KEOPE.S160  
**KSB80E** per KEOPE.SOUNDB80  
**KSB160E** per KEOPE.SOUNDB160  
**KHP60E** per KEOPE.HP60  
**KHP120E** per KEOPE.HP120  
**KM250E** per KEOPE.M250



## RUGGINE / RUST

**K40R** per KEOPE.S40  
**K80R** per KEOPE.S80  
**K160R** per KEOPE.S160  
**KSB80R** per KEOPE.SOUNDB80  
**KSB160R** per KEOPE.SOUNDB160  
**KHP60R** per KEOPE.HP60  
**KHP120R** per KEOPE.HP120  
**KM250R** per KEOPE.M250



## GLICINE / WISTERIA

**K40V** per KEOPE.S40  
**K80V** per KEOPE.S80  
**K160V** per KEOPE.S160  
**KSB80V** per KEOPE.SOUNDB80  
**KSB160V** per KEOPE.SOUNDB160  
**KHP60V** per KEOPE.HP60  
**KHP120V** per KEOPE.HP120  
**KM250V** per KEOPE.M250



## BIANCO / WHITE

**K40W** per KEOPE.S40  
**K80W** per KEOPE.S80  
**K160W** per KEOPE.S160  
**KSB80W** per KEOPE.SOUNDB80  
**KSB160W** per KEOPE.SOUNDB160  
**KHP60W** per KEOPE.HP60  
**KHP120W** per KEOPE.HP120  
**KM250W** per KEOPE.M250

**SOUND8**  
**SOUND8A**  
**SOUND12**  
**SOUND12A**

**Campi applicativi**  
**Application fields**



	<b>SOUND8</b>	<b>SOUND8A</b>	<b>SOUND12</b>	<b>SOUND12A</b>
Descrizione / Description	Diffusore passivo a 2 vie Bass-Reflex 2 way passive speaker Bass-Reflex	Sistema 2 vie biamplificato in Bass-Reflex Bi-amplified 2 way system in Bass-Reflex	Diffusore passivo a 2 vie Bass-Reflex 2 way passive speaker Bass-Reflex	Sistema 2 vie biamplificato in Bass-Reflex Bi-amplified 2 way system in Bass-Reflex
Woofers	20cm (8") magnete ceramico / 20cm (8") ceramic magnet		32cm (12") magnete ceramico / 32cm (12") ceramic magnet	
Driver	a compressione con bocca da 25mm (1") e bobina da 32mm (1.5") compression with 25mm mouth (1") and 32mm coil (1.5")		a compressione con bocca da 25mm (1") e bobina da 44mm (2") compression with 25mm mouth (1") and 44mm coil (2")	
Pannello dei controlli Control Panel	---	Input, MIC, Line, XLR, Link Output	---	Input, MIC, Line, XLR, Link Output
Funzioni Functions	---	Level Mic e Level Line separate + Volume Generale Separate Mic Level and Line Level + Master Volume	---	Level Mic e Level Line separate + Volume Generale Separate Mic Level and Line Level + Master Volume
Controlli di tono / Tone control	---	Bassi, Alti / Bass, High	---	Bassi, Alti / Bass, High
Led	---	Clip Power	---	Clip Power
Tromba / Trumpet	90°H x 60°V	90°H x 60°V	90°H x 60°V	90°H x 60°V
Amplificatore LF/HF / LF/HF Amplifier	---	100W/25W RMS	---	150W/30W RMS
Potenza RMS / musicale RMS / Music Power	120W/200W	---	250W/400W	---
Impedenza / Tensione trasformatore Impedance / Transformer voltage	8Ω	attiva / active	8Ω	attiva / active
Risposta in frequenza / Sensibilità Frequency Response / Sensitivity	70Hz-18kHz -6dB / 95dB	70Hz-18kHz -6dB / 95dB	50Hz-18kHz -6dB / 98dB	50Hz-18kHz -6dB / 98dB
Maximum SPL/peak	116/119dB	116/119dB	120/123dB	120/123dB
Frequenza di Crossover Crossover Frequency	2.5KHz	2.5KHz	1.8KHz	1.8KHz
Connettori Connectors	IN power connettore speakon Linked (in dotazione) IN power connector speakon Linked (included)	IN XLR-JACK-PIN OUT XLR JACK	IN power connettore speakon Linked (in dotazione) IN power connector speakon Linked (included)	IN XLR-JACK-PIN OUT XLR JACK
Ingresso / Input	---	microfono XL/JACK mixabile Mixable XL/JACK microphone	---	---
Alimentazione / Power	---	240V/50-60Hz	---	240V/50-60Hz
Dimensioni (LxHxD) / Size (WxHxD)	265x410x240 mm	265x410x240 mm	400x640x330 mm	400x640x330 mm
Peso / Weight	5,6 kg	7,3 kg	17 kg	19,2 kg
Cabinet - Colore / Color	plastica / plastic antracite / anthracite	plastica / plastic antracite / anthracite	plastica / plastic antracite / anthracite	plastica / plastic antracite / anthracite
Note	4 punti di ancoraggio M8, foro per stativo da 35mm / 4 M8 anchor points, 35mm stand hole Ancoraggio staffa per installazioni a parete / Bracket anchor for wall installations 1 maniglia integrata / 1 integrated handle			

## POWER10A POWER12A

### Campi applicativi Application fields



	POWER10A	POWER12A
Descrizione / Description	Sistema 2 vie biamplificato CLASS-D Bass-Reflex Bi-amplified CLASS-D 2 way system in Bass-Reflex	
Applicazioni Applications	Live Sound P.A., Monitor, D.J. System, Ristoranti, Pub, Club, Auditorium, Teatri, Palestre Live Sound P.A., Monitor, D.J. System, Restaurants, Pub, Club, Auditorium, Theatres, Gym	
Woofer	25cm (10") magnete ceramico progettato per alta efficienza e bassa distorsione 25cm (10") ceramic magnet designed for high efficiency and low distortion	32cm (12") magnete ceramico progettato per alta efficienza e bassa distorsione 32cm (12") ceramic magnet designed for high efficiency and low distortion
Driver	a compressione con bocca da 25mm (1") e bobina da 44mm (2") compression with 25mm (1") mouth and 44mm coil (2")	
Amplificatore LF/HF / LF/HF Amplifier	250W/70W RMS	500W/100W RMS
Amplificatori / Amplifier	equalizzati per ottimizzare la risposta in frequenza equalized to optimize frequency response	
Pannello dei controlli/ Control Panel	Input, MIC, Line, XLR, Link Output	Input, MIC, Line, XLR, Link Output
Funzioni / Functions	Level Mic e Level Line separate + Volume Generale Separate Level Mic and Level Line + General Volume	
Controlli di tono / Tone control	Bassi, Alti / Bass, High	Bassi, Alti / Bass, High
Led	Clip Power, limite del compressore Clip Power, compressor limit	
Tromba / Trumpet	90°H x 60°V a direttività costante 90°H x 60°V at constant directivity	
Risposta in frequenza / Sensibilità Frequency Response / Sensitivity	65Hz-18kHz -3dB 55Hz-20kHz -10dB 96dB	60Hz-18kHz -3dB 55Hz-20kHz -10dB 98dB
Maximum SPL/peak	123/126dB	125/128dB
Dispersione / Dispersion	90°x60° (HxV)	90°x60° (HxV)
Frequenza di Crossover Crossover Frequency	2.2KHz	1.8KHz
IN/OUT	IN Connettore Combo XLR/JACK/ OUT Connettore XLR IN XLR/JACK/OUT Combo Connector XLR Connector	
Alimentazione / Power	switching AC 100-240V/50-60Hz	switching AC 100-240V/50-60Hz
Dimensioni (LxHxD) / Size (WxHxD)	335x545x320 mm	390x630x360 mm
Peso / Weight	16 kg	20 kg
Cabinet	plastica / plastic	plastica / plastic
Colore / Power	antracite / anthracite	antracite / anthracite
Note	5 punti di ancoraggio M10, foro per stativo da 35mm / 5 M10 anchor points, 35mm / stand hole Ancoraggio staffa per installazioni a parete / Bracket anchor for wall installations 3 maniglie integrate / 3 integrated handles	



## Supporto per diffusori SOUND e POWER Support for SOUND and POWER speakers



### STANDWM

Supporto da parete, ancoraggio stabile, per SOUND8/8A, SOUND12/12A, POWER10A/12A  
Dotato di braccio reclinabile e sistema di bloccaggio  
Dimensioni 13,5x25x24 cm (LxHxD)  
Peso 1 Kg  
Materiale metallo verniciato nero

Wall mount, stable anchoring metal bracket for SOUND8 / 8A, SOUND12 / 12A, POWER10A / 12A  
Equipped with reclining arm and locking system  
Size 13.5x25x24 cm (WxHxD)  
Weight 1 Kg  
Black painted metal material



### SCWM8

Supporto a C, da parete, per diffusori SOUND8, SOUND8A.

In-wall bracket for speakers SOUND8, SOUND8A.



### SCWM12

Supporto a C, da parete, per diffusori SOUND12, SOUND12A, POWER10A, POWER12A.

In-wall bracket for speakers SOUND12, SOUND12A, POWER10A, POWER12A.



### ST3

Supporto treppiede da pavimento per:  
- SOUND8, SOUND8A, SOUND12, SOUND12A, POWER10A, POWER12A  
- in abbinamento al SUCS per CS10T, CS20T, CS40, CS40T  
Dotato di sistema di bloccaggio.  
Dimensioni (chiuso) 130x970x130 mm (LxHxD)  
Altezza aperto/max estensione 1940mm. Peso 2,7 Kg. Materiale metallo verniciato nero. Portata 30Kg max.

Floorstand tripod support for:  
SOUND8, SOUND8A, SOUND12, SOUND12A, POWER10A, POWER12A  
- in combination with SUCS for CS10T, CS20T, CS40, CS40T  
Equipped with locking system.  
Size (closed) 130x970x130 mm (WxHxD)  
Height open/ max extension 1940 mm.  
Weight 2,7 Kg. Black painted metal material. Capacity 30Kg max.

## Scatole da incasso per installazione a muratura Built-in boxes for masonry installation

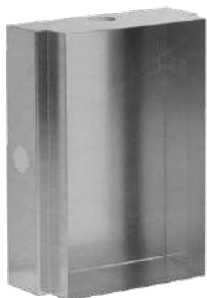

### SR10

Scatola da incasso, rettangolare per installazioni sottotraccia del diffusore GIADA10, GIADA10T.  
Installazione a parete o soffitto.  
Struttura in metallo.  
Dimensioni (LxHxD) 155x210x75 mm.  
Peso 0,4 Kg.  
Colore grigio metallo.  
Particolarmente indicata per parti sottili (spessore max 10 cm).

Recessed box, rectangular for undertrack installations for speakers GIADA10, GIADA10T.  
In wall or ceiling installation.  
Metal frame.  
Size (WxHxD) 155x210x75 mm. Weight 0,4 Kg.  
Metal grey color.  
Particularly suitable for thin parts (max thickness 10 cm).



## SR1

Scatola da incasso, rettangolare per installazioni sottotraccia del diffusore, GIADA13F, GIADA13TF. Installazione a parete o soffitto. Struttura in metallo. Dimensioni (LxHxP) 210x255x90 mm. Peso 0,6 Kg. Colore grigio metallo.

In-built case, rectangular for undertrack installation of the speakers GIADA13F, GIADA13TF. Installation in-wall or in-ceiling. Metal frame. Size (WxHxD) 210x255x90 mm. Weight 0,6 Kg. Metal grey colour.



## SR1S

Scatola da incasso, rettangolare per installazioni sottotraccia del diffusore GIADA13, GIADA13L, GIADA13TL. Installazione a parete o soffitto. Struttura in metallo. Dimensioni (LxHxP) 200x250x75 mm. Peso 0,55 Kg. Colore grigio metallo.

Recessed box, rectangular for undertrack installations of speaker GIADA13, GIADA13L, GIADA13TL. Wall or ceiling installation. Metal frame. Size (WxHxD) 200x250x75 mm. Weight 0,55 Kg. Metal grey color.



## SR2

Scatola da incasso, rettangolare per installazioni sottotraccia del diffusore GIADA16F, GIADA16TF, GIADA16HP, GIADA16HPA. Installazione a parete o soffitto. Struttura in metallo. Dimensioni (LxHxP) 220x305x90 mm. Peso 0,8 Kg. Colore grigio metallo.

In-built case, rectangular for undertrack installation of the speakers GIADA16F, GIADA16TF, GIADA16HP, GIADA16HPA. Installation in-wall or in-ceiling. Metal frame. Size (WxHxD) 220x305x90 mm. Weight 0,8 Kg. Metal grey colour.



## SC2

Scatola da incasso, rettangolare per installazioni sottotraccia del diffusore GIADA213F. Installazione a parete o soffitto. Struttura in metallo. Dimensioni (LxHxP) 410x223x90 mm. Peso 0,8 Kg. Colore grigio metallo.

In-built case, rectangular for undertrack installation of the speaker GIADA213F. Installation in-wall or in-ceiling. Metal frame. Size (WxHxD) 410x223x90 mm. Weight 0,8 Kg. Metal grey colour.



## SR3

Scatola da incasso, rettangolare per installazioni sottotraccia del diffusore GIADA213HP. Installazione a parete o soffitto. Struttura in metallo. Dimensioni (LxHxP) 60x340x90 mm. Peso 0,85 Kg. Colore grigio metallo.

In-built case, rectangular for undertrack installation of the speaker GIADA213HP. Installation in-wall or in-ceiling. Metal frame. Size (WxHxD) 260x340x90 mm. Weight 0,85 Kg. Metal grey colour.



## SR3PLUS

Scatola da incasso, rettangolare per installazioni sottotraccia del diffusore GIADA20HP, GIADA20F, GIADA20TF, GIADA213HP, GIADA20SPF, GIADA20HPF. Installazione a parete o soffitto. Struttura in metallo. Dimensioni (LxHxP) 255x365x135 mm. Peso 1 Kg. Colore grigio metallo.

In-built case, rectangular for undertrack installation of the speakers GIADA20HP, GIADA20F, GIADA20TF, GIADA213HP, GIADA20SPF, GIADA20HPF. Installation in-wall or in-ceiling. Metal frame. Size (WxHxD) 255x365x135 mm. Weight 1 Kg. Metal grey colour.



### SR13

Scatola da incasso, rettangolare per installazioni sottotraccia del diffusore ROUND13TL, ROUND13F, ROUND13TF. Installazione a parete o soffitto. Struttura in metallo. Dimensioni (LxHxP) 219x285x94 mm. Peso 0,9 Kg. Colore grigio metallo.

Recessed box, rectangular for undertrack installations of speaker ROUND13TL, ROUND13F, ROUND13TF. Wall or ceiling installation. Metal frame. Size (WxHxD) 219x285x94 mm. Weight 0,9 Kg. Metal grey color.



### SR16

Scatola da incasso, rettangolare per installazioni sottotraccia del diffusore ROUND16L, ROUND16TL, ROUND16F, ROUND16TF. Installazione a parete o soffitto. Struttura in metallo. Dimensioni (LxHxP) 259x335x94 mm. Peso 1,1 Kg. Colore grigio metallo.

Recessed box, rectangular for undertrack installations of speaker ROUND16L, ROUND16TL, ROUND16F, ROUND16TF. Wall or ceiling installation. Metal frame. Size (WxHxD) 259x335x94 mm. Weight 1,1 Kg. Metal grey color.



### SR20

Scatola da incasso, rettangolare per installazioni sottotraccia del subwoofer, SUBGIADA20SPF, SUBGIADA20SPFA. Installazione a parete o soffitto. Struttura in metallo. Dimensioni (LxHxP) 373x550x151 mm. Peso 1,3 Kg. Colore grigio metallo.

Recessed box, rectangular for undertrack installations of SUBGIADA20F, SUBGIADA20FA, SUBGIADA20SPF, SUBGIADA20SPFA.. Wall or ceiling installation. Metal frame. Size (WxHxD) 373x550x151 mm. Weight 1,3 Kg. Metal grey color.



### SR30

Scatola da incasso, rettangolare per installazioni sottotraccia del subwoofer SUBROUND20SPF, SUBROUND20SPFA, SUBROUND20F, SUBROUND20FA. Installazione a parete o soffitto. Struttura in metallo. Dimensioni (LxHxP) 373x550x131 mm. Peso 1,3 Kg. Colore grigio metallo.

Recessed box, rectangular for undertrack installations of SUBROUND20SPF, SUBROUND20SPFA, SUBROUND20F, SUBROUND20FA. Wall or ceiling installation. Metal frame. Size (WxHxD) 373x550x131 mm. Weight 1,3 Kg. Metal grey color.



### SQR13

Scatola da incasso/calotta tagliafuoco, rettangolare per ROUND13TF. Dimensioni (LxHxP) 185x302x97mm. Peso 1,2 Kg. Colore grigio metallo.

Recessed box/fire cap, rectangular for ROUND13TF. Size (WxHxD) 185x302x97mm. Weight 1,2 Kg. Metal grey color.





## SQR20

Scatola da incasso/calotta tagliafuoco ROUND20TF. Installazione a parete o soffitto. Struttura in metallo. Dimensioni (LxHxP) 263x352x104mm. Peso 1,7 Kg. Colore grigio metallo.

ROUND20TF recessed box/fire cap. Wall or ceiling installation. Metal frame. Size (WxHxD) 263x352x104mm. Weight 1,7 Kg. Metal grey color.



## SR2FC EOL

Accessori per l'installazione a filo muro del diffusore Top Class GIADA16HP. Installazione a parete. Note: per la corretta finitura prima della rasatura è necessario acquistare il Diffusore.

Accessories for installation flush with the plasterboard of the speaker Top Class GIADA16HP. Wall installation. For the correct finishing before shaving, it is necessary to purchase the speaker.



## SR2FM EOL

Accessori per l'installazione a filo muro del diffusore Top Class GIADA16HP. Installazione a parete. Note: per la corretta finitura prima della rasatura è necessario acquistare il Diffusore.

Accessories for installation flush to the wall of the speaker Top Class GIADA16HP. Wall installation. For the correct finishing before shaving, it is necessary to purchase the speaker.



## SR3FC EOL

Accessori per l'installazione a filo cartongesso dei diffusori Top Class GIADA20HP, GIADA213HP. Installazione a parete. Note: per la corretta finitura prima della rasatura è necessario acquistare il diffusore.

Accessories for the installation flush plasterboard of Top Class GIADA20HP, GIADA213HP speakers. Wall installation. Notes: for the correct finishing before shaving it is necessary to purchase speaker.

















## SR3FM EOL

Accessori per l'installazione a filo muro dei diffusori Top Class GIADA213HP. Installazione a parete. Note: per la corretta finitura prima della rasatura è necessario acquistare il diffusore.

Accessories for installation flush to the wall of the speakers Top Class GIADA213. Wall installation. For the correct finishing before shaving, it is necessary to purchase the speaker.



-  **SUBGIADA20F**
-   **SUBGIADA20F.R** (min 10pz)
-  **SUBGIADA20FA**
-   **SUBGIADA20FA.R** (min 10pz)
-  **SUBROUND20F**
-   **SUBROUND20F.R** (min 10pz)
-  **SUBROUND20FA**
-   **SUBROUND20FA.R** (min 10pz)
-  **SR20** scatola da incasso per SUBGIADA
-  **SR30** scatola da incasso per SUBROUND

### Campi applicativi Application fields



	<b>SUBGIADA20F</b>	<b>SUBGIADA20FA</b>	<b>SUBROUND20F</b>	<b>SUBROUND20FA</b>
Descrizione / Description	Subwoofer rettangolare, da incasso, <b>frameless</b> Rectangular subwoofer, recessed, <b>frameless</b>	Kit subwoofer rettangolare, da incasso, <b>frameless</b> Kit in-ceiling rectangular subwoofer, <b>frameless</b> series	Subwoofer rotondo, da incasso, <b>frameless</b> Round subwoofer, recessed, <b>frameless</b>	Kit subwoofer rotondo, da incasso, <b>frameless</b> Kit in-ceiling round subwoofer, <b>frameless</b> series
	passivo / passive	attivo / active	passivo / passive	attivo / active
Woofer	20,5 cm	20,5 cm	20,5 cm	20,5 cm
Potenza RMS / RMS Power	80W	100W	80W	100W
Risposta in frequenza / Frequency response	40-200Hz	40-200Hz	40-200Hz	40-200Hz
Max output level	110dB 1W/1mt	110dB 1W/1mt	110dB 1W/1mt	110dB 1W/1mt
Angolo di dispersione / Dispersion angle	180° (V/O)	180° (V/O)	180° (V/O)	180° (V/O)
Alimentazione / Power supply	---	AL5B included	---	AL5B included
Dimensioni (LxHxP) - (DxP) Size (WxHxD) - (DxD)	242x362x105 mm	242x362x105 mm	277x105 mm	277x115 mm
Foro da incasso (LxH) - (D) / Recessed hole (WxH) - (D)	220x340 mm	220x340 mm	258 mm	258 mm
Peso / Weight	1,9 kg	1,9 kg	1,9 kg	1,9 kg
Cabinet	ABS V0 con griglia di protezione zincata verniciata / ABS V0 with painted galvanized grille			
Colore / Color	bianco / white RAL 9016	bianco / white RAL 9016	bianco / white RAL 9016	bianco / white RAL 9016
Incasso su muratura Recessed on masonry	SR20	SR20	SR30	SR30
Incasso su cartongesso Recessed on plasterboard	non servono accessori, il diffusore nel retro è dotato di ganci per l'ancoraggio stabile no accessories needed, the speaker is provided with hook shaped anchors for stable fixing in the rear			
Temperatura di lavoro Working temperature	da -20° a +65°			



- SUBGIADA20SPF**
- SUBGIADA20SPF.R** (min 10pz)
- SUBGIADA20SPFA**
- SUBGIADA20SPFA.R** (min 10pz)
- SUBROUND20SPF**
- SUBROUND20SPF.R** (min 10pz)
- SUBROUND20SPFA**
- SUBROUND20SPFA.R** (min 10pz)
- SR20** scatola da incasso per SUBGIADA
- SR30** scatola da incasso per SUBROUND

## Campi applicativi Application fields



	<b>SUBGIADA20SPF</b>	<b>SUBGIADA20SPFA</b>	<b>SUBROUND20SPF</b>	<b>SUBROUND20SPFA</b>
Descrizione / Description	Subwoofer rettangolare, da incasso a controsoffitto, <b>frameless</b> . Rectangular subwoofer, recessed to false ceiling, <b>frameless</b>	Kit subwoofer rettangolare, da incasso a controsoffitto, <b>frameless</b> . Kit rectangular subwoofer, recessed false ceiling, <b>frameless</b>	Subwoofer rotondo, da incasso a controsoffitto, <b>frameless</b> . Round subwoofer, recessed to false ceiling, <b>frameless</b>	Kit subwoofer rotondo, da incasso a controsoffitto, <b>frameless</b> . Kit round subwoofer, recessed false ceiling, <b>frameless</b>
	passivo / passive	attivo / active	passivo / passive	attivo / active
Applicazioni / Applications	Ideale per sistemi Home Cinema o diffusions sonore di alta qualità (in abbinamento ai diffusori) Ideal for home cinema systems or high quality sound system (in combination with speakers).			
Woofers	20 cm a doppia bobina 8Ω 20 cm with double coil 8Ω	20 cm	20 cm a doppia bobina 8Ω 20 cm with double coil 8Ω	20 cm
Potenza / Power	250W	140+140W tramite / via E80S	250W	140+140W tramite / via E80S
Risposta in frequenza / Frequency response	35-200Hz	35-200Hz	35-200Hz	35-200Hz
Max output level	---	112dB	---	112dB
Sensibilità / Sensitivity	88dB	---	88dB	---
Angolo di dispersione / Dispersion angle	180° (V/O)	180° (V/O)	180° (V/O)	180° (V/O)
Alimentazione / Power supply	---	AL9B included	---	AL9B included
Dimensioni (LxHxP) - (DxP) Size (WxHxD) - (DxD)	242x362x135 mm	242x362x135 mm	284x104 mm	284x104 mm
Foro da incasso (LxH) - (D) / Recessed hole (WxH) - (D)	220x340 mm	220x340 mm	258 mm	258 mm
Peso / Weight	2,1 kg	2,7 kg	2,0 kg	2,0 kg
Cabinet	ABS V0 con griglia di protezione zincata verniciata / ABS V0 with painted galvanized grille			
Colore / Color	bianco / white RAL 9016	bianco / white RAL 9016	bianco / white RAL 9016	bianco / white RAL 9016
Incasso su muratura Recessed on masonry	SR20*	SR20*	SR30*	SR30*
Incasso su cartongesso Recessed on plasterboard	SR20*	SR20*	SR30*	SR30*
Temperatura di lavoro Working temperature	da -20° a +65°			

\*attenzione con questa tipologia di prodotto è obbligatorio installare la scatola da incasso, per evitare danneggiamenti durante l'uso.  
attention with this type of product it is mandatory to install the flush-mounted box, to avoid damage during use.

**SUB6AW** EOL  
**MINISUB8AB**  
**MINISUB8AW**  
**SUB8ALB**  
**SUB8APB**  
**SUB8APW**

**Campi applicativi**  
**Application fields**



SUB6A



MINISUB8



SUB8AL



SUB8AP



	<b>SUB6AW</b>	<b>MINISUB8A</b>	<b>SUB8AL</b>	<b>SUB8AP</b>
Descrizione / Description	subwoofer amplificato / amplified subwoofer			
Woofers	6x9" ellittico / elliptical	20 cm	20 cm	1x20 cm high performance 1x20 cm passive
Potenza RMS / RMS Power Potenza musicale / Musical power	50W / 100W	100W / 200W	100W / 200W	300W dynamic
Massima pressione sonora Maximum sound pressure	105dB	104dB	105dB	108dB
Gamma utile / Useful range	45-200 Hz	20-160 Hz	20-160 Hz	25-200 Hz
Frequenza di crossover / Crossover frequency	60-200 Hz	40-160 Hz	40-160 Hz	40-200 Hz
Regolazione fase / Phase adjustment	da 0° a 180°	da 0° a 180°	da 0° a 180°	da 0° a 180°
Alimentazione / Power	220 Vca	120/240 Vca	120/240 Vca	120/240 Vca
Consumo / Consumption	100VA	120VA	120VA	120VA
Accensione/Auto Ignition/Auto	On/Off	On/Off	On/Off	On/Off
Dimensioni (LxHxD) / Size (WxHxD)	250x340x300 mm	267x280x305 mm	320x420x270 mm	267x280x305 mm
Peso / Weight	10 kg	8,2 kg	10,5 kg	8,5 kg
Cabinet	MDF impiallacciato / MDF veneer			
Colore / Color	bianco / white	bianco / white nero / black	nero / black	bianco / white nero / black
Temperatura di lavoro / Working temperature	da -20° a +65°	da -20° a +65°	da -20° a +65°	da -20° a +65

**SUB8AB** EOL  
**SUB8AW** EOL  
**SUB10AB**  
**SUB10AW**  
**SUB12AB** EOL  
**SUB12AW** EOL  
**SMARTQUBE**  
**SMARTQUBEW**

**Campi applicativi**  
**Application fields**



SUB8A



SUB10A



SUB12A



SMARTQUBE



	SUB8A	SUB10A	SUB12A	SMARTQUBE
Descrizione / Description	subwoofer amplificato / amplified subwoofer			subwoofer di potenza amplificato / amplified power subwoofer
Woofers	20 cm	25 cm	30 cm	32 cm
Potenza RMS / RMS Power Potenza musicale / Musical power	60W / 120W	150W / 300W	100W / 200W	300W / 600W
Massima pressione sonora Maximum sound pressure	104dB	110dB	109dB	118dB
Gamma utile / Useful range	40-150 Hz	40-200 Hz	40-150 Hz	35-200 Hz
Frequenza di crossover / Crossover frequency		50-200 Hz		50-200 Hz
Regolazione fase / Phase adjustment	da 0° a 180°	da 0° a 180°	da 0° a 180°	da 0° a 180°
Alimentazione / Power supply	115/230Vca auto switch	220 Vca	115/230Vca auto switch	220Vca
Consumo / Consumption	180VA	220VA	250VA	220VA
Accensione / Auto Ignition/Auto	On/Off	On/Off	On/Off	On/Off
Dimensioni (LxHxP) / Size (WxHxD)	265x344x275 mm	370x395x400 mm	355x444x368 mm	435x465x435 mm
Peso / Weight	7,8 kg	14,8 kg	11,7 kg	26 kg
Cabinet	MDF impiallacciato PVC PVC veneered MDF	MDF impiallacciato MDF veneer	MDF impiallacciato PVC PVC veneered MDF	MDF impiallacciato, antirisonante / MDF veneered, anti-resonant
Colore / Color	bianco / white nero / black	bianco / white nero / black	bianco / white nero / black	bianco opaco RAL9003 / white opaque nero opaco RAL9005 / black opaque
Temperatura di lavoro / Working temperature	da -20° a +65°	da -20° a +65°	da -20° a +65°	da -20° a +65°



## SUB15A

### Campi applicativi Application fields



### SUB15A

Descrizione / Description	subwoofer amplificato professionale / professional amplified subwoofer
Applicazioni / Applications	pub, birrerie, sale conferenze, discolive, palestre, ... pubs, breweries, conference rooms, disco live, gyms, ...
Woofers	da 15" con bobina mobile da 2,5" / 15" with 2.5" moving coil
Potenza RMS / RMS Power	400W (program) / 127dB SPL@1m (full power)
Gamma utile / Useful range	50-450Hz
Frequenza di crossover / Crossover frequency	80-250Hz
Connettori / Connectors	XLR/Jack
Dimensioni (LxHxD) / Size (WxHxD)	455x515x415 mm
Peso / Weight	38 kg
Cabinet	MDF con rinforzo interno, griglia nera di acciaio resistente a qualsiasi condizione climatica MDF with internal reinforcement, black grid of steel resistant to any climatic conditions
Finitura / Finishing	verniciata antigraffio / scratch-resistant paint
Colore / Color	nero / black
Temperatura di lavoro / Working temperature	da -20° a +65°
Note	2 maniglie / 2 handles

# ICONS

Legenda icone applicazioni consigliate  
Recommended Application Icon Legend



Negozi  
Shops



Uffici  
Offices



SPA e centri benessere  
SPA



Palestre  
Gyms



Giardini, terrazze, parchi e piscine  
Gardens, terraces, parks and swimming pools



Poliambulatori  
Polyclinics



Sale conferenze  
Conference rooms



Centri sportivi  
Sport centers



Hospitality  
Hospitality

**WiFi**

Dispositivi multimediali WiFi con player Keysol integrato, controllabili da App Vivaldi  
WiFi multimedia devices with integrated Keysol player, control from Vivaldi App



Idoneo all'utilizzo all'esterno  
Suitable for outdoor use



Abitazioni  
Homes



Luoghi di culto  
Places of worship



Imbarcazioni  
Boats



Terziario, Public address, centri commerciali  
Tertiary, Public address, shopping centers



Magazzini e grandi spazi con soffitti alti  
Warehouses and large spaces with high ceilings



Ristoranti, caffetterie, mense, pasticcerie  
Restaurants, cafes, canteens, pastry shops



Home Cinema  
Home Cinema



Locali di intrattenimento, pub, disco  
Entertainment venues, pubs, disco



Cabinet in plastica inifuga  
Fireproof plastic cabinet

# INDICE

indice alfabetico  
alphabetical index

A25SBTC	pag. 82	FLORA10TW	pag. 124
AIR50TB	pag. 125	FLORA13TB	pag. 124
AIR30TB	pag. 125	FLORA13TW	pag. 124
AIR30TW	pag. 125	FLORA16SPB	pag. 124
AIR40TB	pag. 125	FLORA16SPW	pag. 124
AIR40TW	pag. 125	FLORA16TB	pag. 124
AIR50TB	pag. 125	FLORA16TW	pag. 124
AIR50TW	pag. 125	GHOST930	pag. 107
AL10B	pag. 59	GHOST930SUB	pag. 107
AL203	pag. 59	GIADA10F	pag. 84
AL3B	pag. 83	GIADA10F.R	pag. 84
AL5B	pag. 57	GIADA10TF	pag. 84
AL6B	pag. 17	GIADA10TF.R	pag. 84
AL7B	pag. 57	GIADA13AF	pag. 108
AL9B	pag. 59	GIADA13AF.R	pag. 108
AMBRA10TB	pag. 123	GIADA13F	pag. 108
AMBRA10TW	pag. 123	GIADA13F.R	pag. 108
AMBRA16TB	pag. 123	GIADA13TF	pag. 108
AMBRA16TW	pag. 123	GIADA13TF.R	pag. 108
AMBRA21TB	pag. 123	GIADA16AF	pag. 110
AMBRA21TW	pag. 123	GIADA16AF.R	pag. 110
AMBRA9TB	pag. 123	GIADA16F	pag. 110
AMBRA9TW	pag. 123	GIADA16F.R	pag. 110
ANNA13TB	pag. 126	GIADA16HP	pag. 111
ANNA13TW	pag. 126	GIADA16HP.R	pag. 111
ANNA16TB	pag. 126	GIADA16HPA	pag. 111
ANNA16TW	pag. 126	GIADA16HPA.R	pag. 111
ANNA20TB	pag. 126	GIADA16HPF	pag. 110
ANNA20TW	pag. 126	GIADA16HPF.R	pag. 110
BM6	pag. 97	GIADA16HPFA	pag. 110
BS6	pag. 97	GIADA16HPFA.R	pag. 110
C4IO	pag. 16	GIADA16TF	pag. 110
CR1	pag. 97	GIADA16TF.R	pag. 110
CS10T	pag. 127	GIADA20AF	pag. 112
CS20T	pag. 127	GIADA20AF.R	pag. 112
CS40	pag. 127	GIADA20F	pag. 112
CS40T	pag. 127	GIADA20F.R	pag. 112
DA8	pag. 102	GIADA20HPF	pag. 112
E30S	pag. 72	GIADA20HPF.R	pag. 112
E80S	pag. 74	GIADA20HPFA	pag. 112
FLORA10TB	pag. 124	GIADA20HPFA.R	pag. 112

GIADA20SPF	pag.	113	KEOPE.M250WIFI	pag.	42
GIADA20SPF.R	pag.	113	KEOPE.S160	pag.	136
GIADA20TF	pag.	112	KEOPE.S40	pag.	136
GIADA20TF.R	pag.	112	KEOPE.S40WIFI	pag.	40
GIADA213F	pag.	112	KEOPE.S80	pag.	136
GIADA213F.R	pag.	112	KEOPE.S80WIFI	pag.	40
GIADA213HP	pag.	111	KEOPE.SOUNDB160	pag.	138
GIADA213HP.IP	pag.	111	KEOPE.SOUNDB160WIFI	pag.	41
GIADA213HP.R	pag.	111	KEOPE.SOUNDB80	pag.	138
GIADA213HPF	pag.	111	KEOPE.SOUNDB80WIFI	pag.	41
GIADA213HPF.R	pag.	111	KBOX	pag.	46
GIADA506F	pag.	84	KEYGREEN16A	pag.	48
GIADA506F.R	pag.	84	KEYROCK20A	pag.	47
GIADA506TF	pag.	84	KEYROUND16AF	pag.	38
GIADA506TF.R	pag.	84	KEYROUND16AF.R	pag.	38
GREEN16T	pag.	129	KEYSOL	pag.	26
GRM1	pag.	103	KEYSOL-DIN	pag.	28
INVISIBLE65	pag.	106	KEYSOL15-S	pag.	32
INVISIBLE65T	pag.	106	KEYZEN315A	pag.	49
K160A	pag.	140	KEYZEN510A	pag.	50
K160B	pag.	140	KEYZEN730A	pag.	51
K160C	pag.	141	KHP120A	pag.	140
K160E	pag.	141	KHP120B	pag.	140
K160G	pag.	140	KHP120C	pag.	141
K160R	pag.	141	KHP120E	pag.	141
K160S	pag.	140	KHP120G	pag.	140
K160V	pag.	141	KHP120R	pag.	141
K160W	pag.	141	KHP120S	pag.	140
K40A	pag.	140	KHP120V	pag.	141
K40B	pag.	140	KHP120W	pag.	141
K40C	pag.	141	KHP60A	pag.	140
K40E	pag.	141	KHP60B	pag.	140
K40G	pag.	140	KHP60C	pag.	141
K40R	pag.	141	KHP60E	pag.	141
K40S	pag.	140	KHP60G	pag.	140
K40V	pag.	141	KHP60R	pag.	141
K40W	pag.	141	KHP60S	pag.	140
K80A	pag.	140	KHP60V	pag.	141
K80B	pag.	140	KHP60W	pag.	141
K80C	pag.	141	KM250A	pag.	140
K80E	pag.	141	KM250B	pag.	140
K80G	pag.	140	KM250C	pag.	141
K80R	pag.	141	KM250E	pag.	141
K80S	pag.	140	KM250G	pag.	140
K80V	pag.	141	KM250R	pag.	141
K80W	pag.	141	KM250S	pag.	140
KEOPE.HP120	pag.	137	KM250V	pag.	141
KEOPE.HP60	pag.	137	KM250W	pag.	141
KEOPE.HP60WIFI	pag.	42	KSB160A	pag.	140
KEOPE.M250	pag.	137			



KSB160B	pag. 140	PERLA13TP	pag. 109
KSB160C	pag. 141	PERLA13TP.R	pag. 109
KSB160E	pag. 141	PH208TPRO	pag. 128
KSB160G	pag. 140	PH210TPRO	pag. 128
KSB160R	pag. 141	PH212TPRO	pag. 128
KSB160S	pag. 140	PH50HIFI	pag. 128
KSB160V	pag. 141	PLANA2	pag. 121
KSB160W	pag. 141	PLANA2B	pag. 121
KSB80A	pag. 140	PLANA2T	pag. 121
KSB80B	pag. 140	PLANA2TB	pag. 121
KSB80C	pag. 141	PMA2120	pag. 98
KSB80E	pag. 141	PMA2240	pag. 98
KSB80G	pag. 140	PMA2500	pag. 98
KSB80R	pag. 141	POWER10A	pag. 143
KSB80S	pag. 140	POWER12A	pag. 143
KSB80V	pag. 141	PS1000	pag. 100
KSB80W	pag. 141	PS3000	pag. 100
LARA10TB	pag. 122	PSA300MK2	pag. 99
LARA10TW	pag. 122	PSA4300	pag. 101
LARA9TB	pag. 122	PSA4500	pag. 101
LARA9TW	pag. 122	PSA500MK2	pag. 99
MA5060BTK	pag. 94	PSA6500	pag. 102
MA5120BTK	pag. 94	PSA8500	pag. 102
MA5240BTK	pag. 94	RG10FB	pag. 84
MARINE6	pag. 120	RG13FB	pag. 108
MARINE6T	pag. 120	RG16FB	pag. 110
MARINE7	pag. 120	RG506FB	pag. 84
MARINE7T	pag. 120	ROCK20T	pag. 129
MATRIX6	pag. 70	ROUND7F	pag. 85
MICRO2	pag. 17	ROUND7F.R	pag. 85
MINI8B	pag. 122	ROUND7TF	pag. 85
MINI8B.IP	pag. 122	ROUND7TF.R	pag. 85
MINI8W	pag. 122	ROUND13F	pag. 85
MINI8W.IP	pag. 122	ROUND13F.R	pag. 85
MINISUB8AB	pag. 150	ROUND13TF	pag. 85
MINISUB8AW	pag. 150	ROUND13TF.R	pag. 85
MS6120BTK	pag. 96	ROUND16AF	pag. 114
MS6240BTK	pag. 96	ROUND16AF.R	pag. 114
MZ6120BTK	pag. 95	ROUND16F	pag. 114
MZ6240BTK	pag. 95	ROUND16F.R	pag. 114
MZ6350BTK	pag. 95	ROUND16TF	pag. 114
MZ6500BTK	pag. 95	ROUND16TF.R	pag. 114
OPERA	pag. 119	ROUND17TF	pag. 114
P30S	pag. 56	ROUND17TF.R	pag. 114
P40SL	pag. 34	ROUND20AF	pag. 115
P80S	pag. 58	ROUND20AF.R	pag. 115
PBT	pag. 83	ROUND20F	pag. 115
PERLA13P	pag. 109	ROUND20F.R	pag. 115
PERLA13P.R	pag. 109	ROUND20HPF	pag. 116

ROUND20HPF.R	pag.	116	SUB8APW	pag.	150
ROUND20SPF	pag.	117	SUB8AW	pag.	151
ROUND20SPF.R	pag.	117	SUBGIADA20F	pag.	148
ROUND20TF	pag.	115	SUBGIADA20F.R	pag.	148
ROUND20TF.R	pag.	115	SUBGIADA20FA	pag.	148
RR7FB	pag.	85	SUBGIADA20FA.R	pag.	148
RR13F	pag.	85	SUBGIADA20SPF	pag.	149
RR13FB	pag.	85	SUBGIADA20SPF.R	pag.	149
RR16FB	pag.	114	SUBGIADA20SPFA	pag.	149
SC2	pag.	145	SUBGIADA20SPFA.R	pag.	149
SC100	pag.	97	SUBINVISIBLE50	pag.	106
SC930	pag.	107	SUBINVISIBLE50T	pag.	106
SCWM12	pag.	144	SUBROUND20F	pag.	148
SCWM8	pag.	144	SUBROUND20F.R	pag.	148
SMARTQUBEB	pag.	151	SUBROUND20FA	pag.	148
SMARTQUBEW	pag.	151	SUBROUND20FA.R	pag.	148
SOUND12	pag.	142	SUBROUND20SPF	pag.	149
SOUND12A	pag.	142	SUBROUND20SPF.R	pag.	149
SOUND8	pag.	142	SUBROUND20SPFA	pag.	149
SOUND8A	pag.	142	SUBROUND20SPFA.R	pag.	149
SQR13	pag.	146	SUPERZEN	pag.	134
SQR20	pag.	147	TELEMACO	pag.	9
SR1	pag.	145	TVE	pag.	17
SR10	pag.	144	TVM	pag.	73
SR13	pag.	146	TVS	pag.	73
SR16	pag.	146	WB1	pag.	139
SR1S	pag.	145	WB2	pag.	139
SR2	pag.	145	WB3	pag.	139
SR20	pag.	146	ZEN315	pag.	132
SR2FC	pag.	147	ZEN315L	pag.	135
SR2FM	pag.	147	ZEN315T	pag.	132
SR3	pag.	145	ZEN510	pag.	132
SR10	pag.	144	ZEN510T	pag.	132
SR30	pag.	146	ZEN730	pag.	133
SR3FC	pag.	147	ZEN730L	pag.	135
SR3FM	pag.	147	ZEN730T	pag.	133
SR3PLUS	pag.	145	ZEN780	pag.	133
ST212	pag.	128	ZEN780A	pag.	133
ST3	pag.	144	ZEN930	pag.	134
STANDWM	pag.	144	ZEN930T	pag.	134
SUB10AB	pag.	151	ZEN980	pag.	134
SUB10AW	pag.	151	ZEN980A	pag.	134
SUB12AB	pag.	151			
SUB12AW	pag.	151			
SUB15A	pag.	152			
SUB6AW	pag.	150			
SUB8AB	pag.	151			
SUB8ALB	pag.	150			
SUB8APB	pag.	150			



SEGUICI ANCHE SU  
FOLLOW US ALSO ON

**#vivaldiunitedgroup**



<b>Vivaldi srl</b> Via E. Fermi, 8 Via T. A. Edison, 2 30020 Noventa di Piave (VE)	+39 0421 307825 info@vivaldigroup.it vivaldigroup.it
<b>invio merci</b> Via T. A. Edison, 4 30020 Noventa di Piave (VE)	<b>Vivaldi International</b> +39 0421 307825 ext 0 vivaldi@vivaldigroup.it



**Vivaldi srl**  
**divisione di Vivaldi United Group**

Noventa di Piave (VENEZIA) - Italia

**VIVALDI**