

# TWIST

Torrette a scomparsa filo pavimento

Flush floor outlet socket boxes

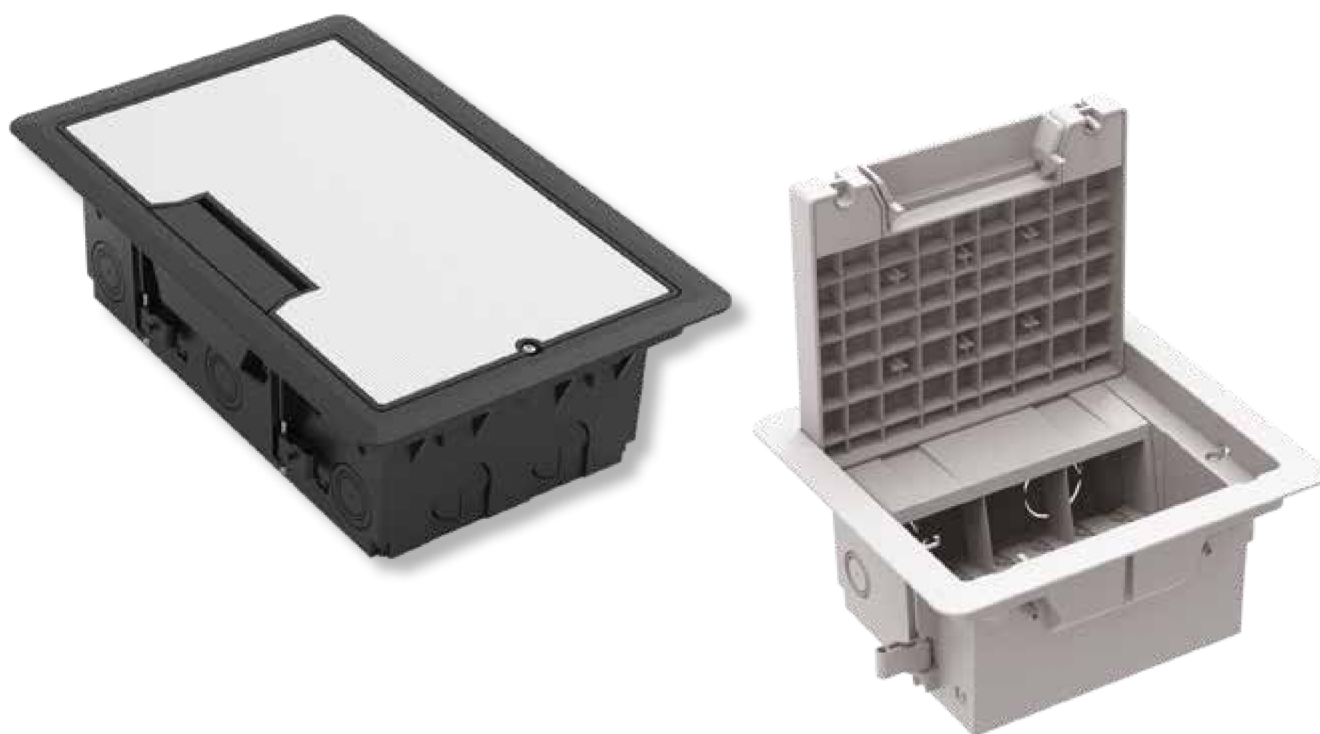



## Caratteristiche Tecniche

- Scatola ed accessori in plastica PC+ABS rinforzato
- Apertura coperchio con attrezzo
- Resistenza al carico puntuale 1500 N (Circa 150 kg)
- Resistenza al carico distribuito 3000 N (Circa 300 kg)

## Grado di protezione

- IP52 tra cornice e pavimento
- IP40 per coperchio
- IP20 ingresso cavi

## Riferimenti a Norme

- La linea è conforme alla norma CEI EN 60670-23
- La linea è conforme alla norma CEI EN 50085-2-2
- La linea è conforme alla Direttiva RoHS 2015/863/EU
- La linea è conforme alla Direttiva B.T. 2009/95/CE

## Marchi e Certificazioni

- Marchio IMQ riferimento n° CA02.05791
- Marcatura CE

## Colori disponibili

- Grigio RAL7040, Nero RAL7021

## Technical Features

- PC+ABS reinforced plastic box and accessories
- Cover disassembling with tool
- Ferrule load resistance 1500 N (About 150 Kg)
- Distributed load resistance 3000 N (About 300 Kg)

## Protection Degree

- IP52 between frame and floor
- IP40 for cover
- IP20 Input cable point

## Norms Reference

- The system complied to CEI EN 60670-23
- The system complied to CEI EN 50085-2-2
- The system complied to RoHS 2015/863/EU
- The system complied to L.V.D. 2009/95/CE

## Marks and Certifications





- Mark IMQ reference n° CA02.05791
- Marking CE

## Available colours

- Grey RAL7040, Black RAL7021

## Torrette a scomparsa vuote per 1 supporto Empty flush floor box for 1 support frame



Articolo Item	Colore Color	Coperchio Cover	A mm	B mm	C mm	D mm	E mm
 <b>NEW</b> <b>SFP04</b>	Grigio Grey	Standard reversibile Reversible standard	222	197	164	189	102
 <b>NEW</b> <b>SFP04X</b>	Grigio Grey	Inserto in acciaio inox Stainless steel insert					
 <b>NEW</b> <b>SFP04.2</b>	Nero Black	Standard reversibile Reversible standard					
 <b>NEW</b> <b>SFP04X.2</b>	Nero Black	Inserto in acciaio inox Stainless steel insert					

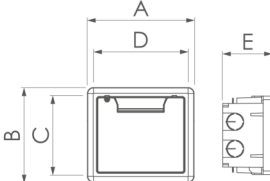

## Torrette a scomparsa vuote per 2 supporti Empty flush floor box for 2 support frames



Articolo Item	Colore Color	Coperchio Cover	A mm	B mm	C mm	D mm	E mm
 <b>SFP08</b>	Grigio Grey	Standard reversibile Reversible standard	339	222	188	305	102
 <b>SFP08X</b>	Grigio Grey	Inserto in acciaio inox Stainless steel insert					
 <b>SFP08.2</b>	Nero Black	Standard reversibile Reversible standard					
 <b>SFP08X.2</b>	Nero Black	Inserto in acciaio inox Stainless steel insert					



## Torrette a scomparsa vuote per 4 supporti Empty flush floor box for 4 support frames



Articolo Item		Colore Color	Coperchio Cover	A mm	B mm	C mm	D mm	E mm
	<b>SFP16</b>	Grigio Grey	Standard reversibile Reversible standard	339	374	340	305	102
	<b>SFP16X</b>	Grigio Grey	Inserto in acciaio inox Stainless steel insert					
	<b>SFP16.2</b>	Nero Black	Standard reversibile Reversible standard					
	<b>SFP16.2X</b>	Nero Black	Inserto in acciaio inox Stainless steel insert					

## Guarnizioni per bordo torrette Seal for underfloor box



Articolo Item		Per torrette For turrets	
	<b>SGA04</b>	<b>NEW</b>	SFP04
	<b>SGA08</b>		SFP08 / SFP12 / SFP06 / SFP09
	<b>SGA16</b>		SFP16 / SFP24 / SFP12-45 / SFP18-45





## Pomello in alluminio per apertura manuale Aluminium knob for manual opening

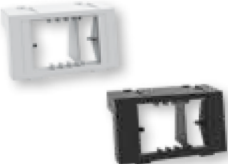

Articolo Item	A mm	B mm	C mm	Dimensioni Dimensions
<b>ST-BOX</b>	26	15	3	

## Supporti porta apparecchi Support frame for devices

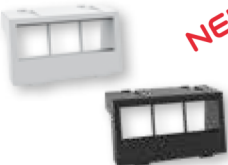

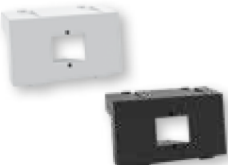
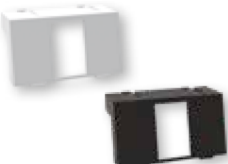
Articolo Item		Colore Color	Descrizione Description
	<b>SMP43</b>	Grigio Grey	Supporto universale per telai a 4 moduli standard italiano con riduttore a 3 moduli di qualsiasi produttore <b>(per placche con dimensione massima 142x86 mm)</b>
	<b>SMP43.2</b>	Nero Black	Universal support for 4-module frames Italian standard with reducing piece for 3 modules of any manufacturer <b>(for plates with maximum dimension 142x86 mm)</b>
	<b>SMP6V</b>	Grigio Grey	Supporto autoportante con attacchi a scatto per massimo 6 moduli della serie <b>Vimar Plana</b> (le prese si applicano a scatto direttamente sul supporto)
	<b>SMP6V.2</b>	Nero Black	Self-supporting frame with coupling for maximum 6 modules <b>Vimar Plana</b> (the sockets snap directly onto the frame)
	<b>SMP6L</b>	Grigio Grey	Supporto autoportante con attacchi a scatto per massimo 6 moduli della serie <b>BTicino Living Light</b> (le prese si applicano a scatto direttamente sul supporto)
	<b>SMP6L.2</b>	Nero Black	Self-supporting frame with coupling for maximum 6 modules <b>BTicino Living Light</b> (the sockets snap directly onto the frame)
	<b>SMP6M</b>	Grigio Grey	Supporto autoportante con attacchi a scatto per massimo 6 moduli della serie <b>BTicino Matix</b> (le prese si applicano a scatto direttamente sul supporto)
	<b>SMP6M.2</b>	Nero Black	Self-supporting frame with coupling for maximum 6 modules <b>BTicino Matix</b> (the sockets snap directly onto the frame)
	<b>SMP6A</b>	Grigio Grey	Supporto autoportante con attacchi a scatto per massimo 6 moduli della serie <b>AVE 44</b> (le prese si applicano a scatto direttamente sul supporto)
	<b>SMP6A.2</b>	Nero Black	Self-supporting frame with coupling for maximum 6 modules <b>AVE 44</b> (the sockets snap directly onto the frame)
	<b>SMP45</b>	Grigio Grey	Supporto autoportante con attacchi a scatto per massimo 3 moduli <b>45x45 mm</b> (le prese si applicano a scatto direttamente sul supporto)
	<b>SMP45.2</b>	Nero Black	Self-supporting frame with coupling for maximum 3 modules <b>45x45 mm</b> (the sockets snap directly onto the frame)
	<b>SMP11</b>	Grigio Grey	Supporto per <b>interruttori modulari</b> massimo 2 moduli da 17,5 mm
	<b>SMP11.2</b>	Nero Black	Support frame for <b>modular switches</b> maximum 2 modules of 17,5 mm
	<b>SMP14</b>	Grigio Grey	Supporto per <b>interruttori modulari</b> massimo 4 moduli da 17,5 mm
	<b>SMP14.2</b>	Nero Black	Support frame for <b>modular switches</b> maximum 4 modules of 17,5 mm

## Supporti porta apparecchi in orizzontale standard francese Supports frames for devices with French standard



Articolo Item	Colore Color	Descrizione Description
	<b>SMF45-3</b> Grigio Grey	Supporto piano autoportante con attacchi a scatto per massimo 3 moduli <b>45x45 mm</b> , installabile su scatola SFP04 o SFP08 (le prese si applicano a scatto direttamente sul supporto)  Flat self-supporting frame with coupling for maximum 3 modules <b>45x45 mm</b> , installable on SFP04 or SFP08 box (the sockets snap directly onto the frame)
	<b>SMF45-3.2</b> Nero Black	
	<b>SMF45-6</b> Grigio Grey	Supporto piano autoportante con attacchi a scatto per massimo 6 moduli <b>45x45 mm</b> , installabile solo su scatola SFP16 (le prese si applicano a scatto direttamente sul supporto)  Flat self-supporting frame with coupling for maximum 6 modules <b>45x45 mm</b> , installable only on SFP16 box (the sockets snap directly onto the frame)
	<b>SMF45-6.2</b> Nero Black	

## Cassaforma in lamiera con coperchio e adattatori Formwork of galvanized sheet iron with cover and adapters



Articolo Item	Per torrette For turrets	A mm	B mm	C mm	D mm	E mm	Dimensioni Dimension
	SFP04	214	236	165	78	103	
	SFP08 SFP12 SFP06 SFP09	236	310	191	78	103	
	SFP16 SFP24 SFP12-45 SFP18-45	388	310	343	78	103	

### Cassaforma annegata nel calcestruzzo Formwork embedded in concrete

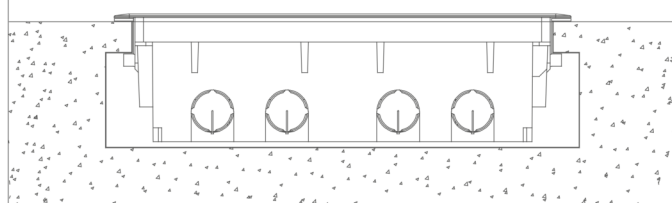

Gli adattatori hanno delle pretranciate, 2 per tubi  $\varnothing 20$  o  $\varnothing 25$  mm e 1 per canale 30x75 mm o 30x110 mm

The adapters have precuttings, 2 for pipes  $\varnothing 20$  or  $\varnothing 25$  mm and 1 for trunking 30x75 mm or 30x110 mm

## Torrette complete di supporti porta apparecchi Turrets with supports frames



Articolo Item	Colore Color	Coperchio Cover	Descrizione Description
	<b>SFP08-2M</b>	Grigio Grey	<b>Moduli totali 8</b> Torretta fornita con 2 supporti universali articolo SMP43 per 4 moduli <b>standard ITALIANO</b> (con riduttore a 3 moduli)
	<b>SFP08-2M.2</b>	Nero Black	
	<b>SFP08-2MX</b>	Grigio Grey	<b>Total modules 8</b> Turret supplied with 2 universal supporting frames item SMP43 for 4 modules <b>ITALIAN standard</b> (with reducer for 3 modules)
	<b>SFP08-2MX.2</b>	Nero Black	
	<b>SFP12V</b>	Grigio Grey	<b>Moduli totali 12</b> Torretta fornita con 2 supporti AUTOPORTANTI articolo SMP6V per 6 moduli <b>VIMAR Plana</b>
	<b>SFP12VX</b>	Grigio Grey	<b>Total modules 12</b> Turret supplied with 2 self-supporting frames item SMP6V for 6 modules <b>VIMAR Plana</b>
	<b>SFP12L</b>	Grigio Grey	<b>Moduli totali 12</b> Torretta fornita con 2 supporti AUTOPORTANTI articolo SMP6L per 6 moduli <b>BTicino LivingLight</b>
	<b>SFP12LX</b>	Grigio Grey	<b>Total modules 12</b> Turret supplied with 2 self-supporting frames item SMP6L for 6 modules <b>BTicino LivingLight</b>
	<b>SFP12A</b>	Grigio Grey	<b>Moduli totali 12</b> Torretta fornita con 2 supporti AUTOPORTANTI articolo SMP6A per 6 moduli <b>AVE44</b>
	<b>SFP12AX</b>	Grigio Grey	<b>Total modules 12</b> Turret supplied with 2 self-supporting frames item SMP6A for 6 modules <b>AVE44</b>

## Torrette complete di supporti porta apparecchi Turrets with supports frames



Articolo Item	Colore Color	Coperchio Cover	Descrizione Description
	<b>SFP16-4</b>	Grigio Grey	Standard reversibile Reversible standard
	<b>SFP16-4.2</b>	Nero Black	
	<b>SFP16-4X</b>	Grigio Grey	Insero in acciaio inox Stainless steel insert
	<b>SFP16-4X.2</b>	Nero Black	
			<b>Moduli totali 16</b> Torretta fornita con 4 supporti universali articolo SMP43 per 4 moduli <b>standard ITALIANO</b> (con riduttore a 3 moduli)  <b>Total modules 16</b> Turret supplied with 4 universal supporting frames item SMP43 for 4 modules <b>ITALIAN standard</b> (with reducer for 3 modules)
	<b>SFP24V</b>	Grigio Grey	Standard reversibile Reversible standard
	<b>SFP24VX</b>	Grigio Grey	Insero in acciaio inox Stainless steel insert
			<b>Moduli totali 24</b> Torretta fornita con 4 supporti AUTOPORTANTI articolo SMP6V per 6 moduli <b>VIMAR Plana</b>  <b>Total modules 24</b> Turret supplied with 4 self-supporting frames item SMP6V for 6 modules <b>VIMAR Plana</b>
	<b>SFP24L</b>	Grigio Grey	Standard reversibile Reversible standard
	<b>SFP24LX</b>	Grigio Grey	Insero in acciaio inox Stainless steel insert
			<b>Moduli totali 24</b> Torretta fornita con 4 supporti AUTOPORTANTI articolo SMP6L per 6 moduli <b>BTicino LivingLight</b>  <b>Total modules 24</b> Turret supplied with 4 self-supporting frames item SMP6L for 6 modules <b>BTicino LivingLight</b>
	<b>SFP24A</b>	Grigio Grey	Standard reversibile Reversible standard
	<b>SFP24AX</b>	Grigio Grey	Insero in acciaio inox Stainless steel insert
			<b>Moduli totali 24</b> Torretta fornita con 4 supporti AUTOPORTANTI articolo SMP6A per 6 moduli <b>AVE44</b>  <b>Total modules 24</b> Turret supplied with 4 self-supporting frames item SMP6A for 6 modules <b>AVE44</b>



## Torrette complete di supporti porta apparecchi Turrets with supports frames



Articolo Item		Colore Color	Coperchio Cover	Descrizione Description
	<b>SFP06-45</b>	Grigio Grey	Standard reversibile Reversible standard	<b>Moduli totali 6</b> Torretta fornita con 2 supporti AUTOPORTANTI articolo SMP45 per 3 moduli 45x45 mm <b>standard Francese</b>
	<b>SFP06-45.2</b>	Nero Black		<b>Total modules 6</b> Turret supplied with 2 self-supporting frames item SMP45 for 3 modules 45x45 mm <b>French standard</b>
	<b>SFP12-45</b>	Grigio Grey		<b>Moduli totali 12</b> Torretta fornita con 4 supporti AUTOPORTANTI articolo SMP45 per 3 moduli 45x45 mm <b>standard Francese</b>
	<b>SFP12-45.2</b>	Nero Black		<b>Total modules 12</b> Turret supplied with 4 self-supporting frames item SMP45 for 3 modules 45x45 mm <b>French standard</b>

## Torrette complete di supporti porta apparecchi Turrets with supports frames



Articolo Item		Colore Color	Coperchio Cover	Descrizione Description
	<b>SFP09-45F</b>	Grigio Grey	Standard reversibile Reversible standard	<b>Moduli totali 9</b> Torretta fornita con 3 supporti piatti AUTOPORTANTI articolo SMF45-3 per 3 moduli 45x45 mm <b>standard Francese</b>
	<b>SFP09-45F.2</b>	Nero Black		<b>Total modules 9</b> Turret supplied with 3 flat self-supporting frames item SMF45-3 for 3 modules 45x45 mm <b>French standard</b>
	<b>SFP18-45F</b>	Grigio Grey		<b>Moduli totali 18</b> Torretta fornita con 3 supporti piatti AUTOPORTANTI articolo SMF45-6 per 6 moduli 45x45 mm <b>standard Francese</b>
	<b>SFP18-45F.2</b>	Nero Black		<b>Total modules 18</b> Turret supplied with 3 flat self-supporting frames item SMF45-6 for 6 modules 45x45 mm <b>French standard</b>

## 3 soluzioni diverse per i coperchi 3 different solutions for the covers

**(1)** Coperchio versione standard utilizzando il lato liscio. **(2)** Per applicare una mattonella, moquette o parquet utilizzare il bassofondo sul retro del coperchio standard.

**(1)** Standard version cover using the smooth side. **(2)** To apply a tile, carpet or parquet use the embedding on the back of the standard cover.

Spessore max 7 mm  
Thickness max 7 mm

**(3)** Coperchio con inserto in acciaio inox antiscivolo.

**(3)** Cover with insert in non-slip stainless steel.

Articolo Item			Articolo Item		
4 moduli 4 modules	8 moduli 8 modules	16 moduli 16 modules	4 moduli 4 modules	8 moduli 8 modules	16 moduli 16 modules
SFP04 SFP04.2	SFP08 SFP08.2	SFP16 SFP16.2	SFP04X SFP04X.2	SFP08X SFP08X.2	SFP16X SFP16X.2

**1**

**2**

**3**

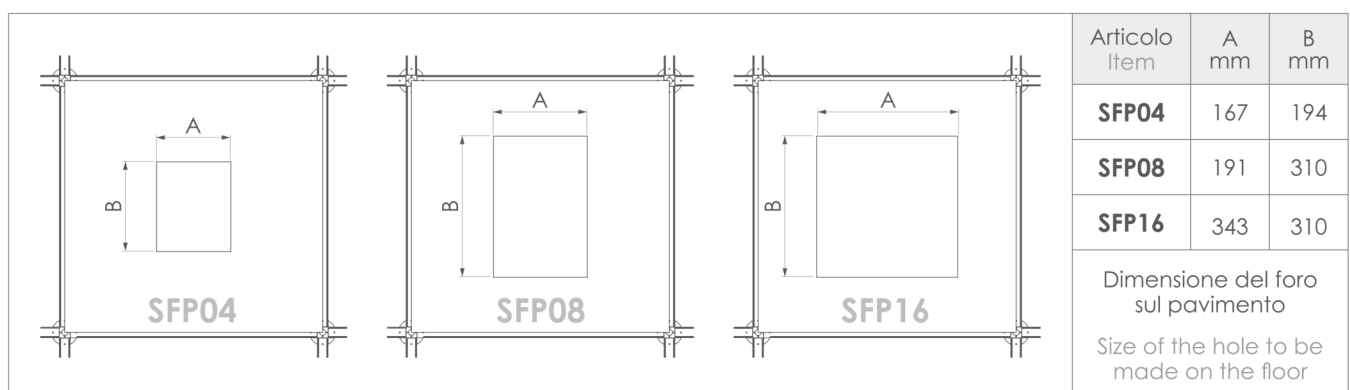
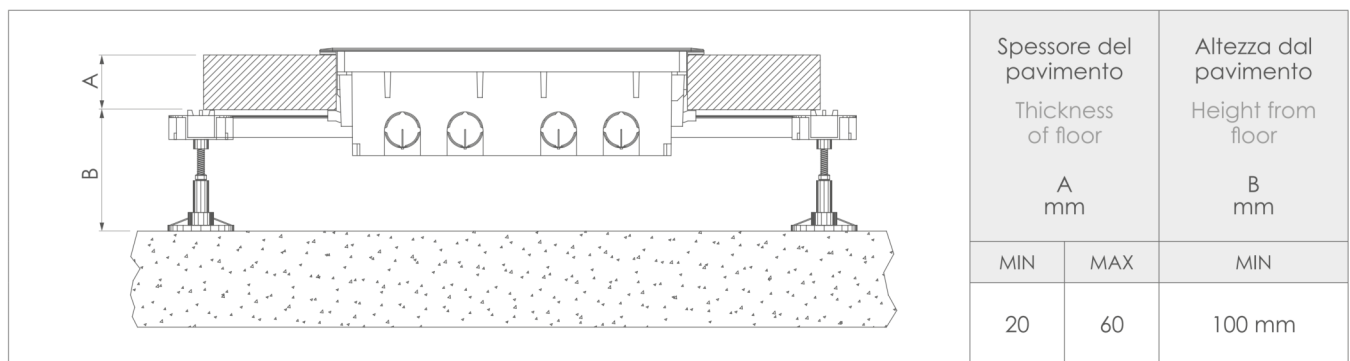

## Vantaggi del sistema Advantages of the system



### Chiusura di sicurezza

Un sistema esclusivo di chiusura del coperchio, mediante una vite speciale con filettatura metrica, che si impegna in una boccia in ottone assicurata alla base, evita sgradevoli manomissioni o modifiche non volute.

### Safe closing

The boxes of the line Twist have an exclusive closing system for the cover through a special screw with metric thread which enters a brass bush fixed to the base. Such closing system avoids any unwanted alteration.



### Uscita cavi

Per non danneggiare pericolosamente i cavi contenuti all'interno della scatola a filo pavimento, la forma interna ed esterna della zona di uscita cavi è smussata, in modo tale da facilitare la curvatura dei cavi al suo interno.

### Cable exit

In order to not damage dangerously the cables contained in the box, both the internal and external shape of the cable exit zone is rounded off, so that it is easier to bend the cables.



### Rimozione del coperchio

I coperchi sono facilmente estraibili dalla base della scatola a filo pavimento, in modo tale da evitare graffi e rotture del coperchio stesso e facilitando la lavorazione da parte dell'operatore all'interno della torretta. Inoltre è possibile applicare un rivestimento all'interno del bassofondo.

### Removal of the Cover

The covers can be easily removed from the base of the box in order to avoid scratches and breaking of the cover itself, and to make it easier for the operator to work within the box. It is also possible to apply a tile, carpet or parquet use the embedding on the back of the cover.



### Tenuta cavi

Per facilitare la chiusura del coperchio è presente all'interno della scatola un ponticello che raggruppa i cavi in modo ordinato, evitando l'usura ed il danneggiamento involontario dei cavi contenuti al suo interno.

### Cable keeping

In order to make it easier to close the cover, within the box there is a bond which gathers the cables tidily. Such system avoids any wear and tear and unintentional damages of the cables which are inside.

## Vantaggi del sistema Advantages of the system



### Tenuta coperchio

Il ponticello, oltre ad avere la funzione di raccolta cavi, viene utilizzato anche per tenere sollevato il coperchio durante l'inserimento dei cavi o per la manutenzione, evitandone la caduta accidentale sulle mani dell'operatore.

### Cover keeping

Besides gathering the cables, the bond is also used in order to keep the cover open while inserting the cables and for the maintenance, avoiding so the falling over the hands of the user.



### Facilità di applicazione

Si possono montare su pavimenti flottanti con mattonelle di spessore da 20 a 60 mm. Il sistema esclusivo di ritorno dei piedini di tenuta, mediante un elastico, permette un agevole montaggio e smontaggio della scatola.

### Easy to install

They can be mounted on floating floors with tiles having a thickness from 20 to 60 mm. The feet are re-positioned by a rubber, and this allows an easy assembly and disassembly of the box.



### Mostrine universali e autoportanti

All'interno delle torrette a scomparsa è possibile applicare 3 tipologie di mostrina: 1) Mostrina universale per il montaggio di telai e placche a 3/4 moduli con standard italiano di qualsiasi produttore, con dimensione massima della placca inseribile di 142x86 mm; 2) Mostrina autoportante in verticale per il montaggio a scatto di prese con standard italiano o standard francese; 3) Mostrina autoportante in piano per il montaggio di prese con standard francese 45x45 mm (standard adeguato per il solo mercato estero).

### Universal and self-supporting frames

Inside the retractable turrets it is possible to apply 3 types of frames: 1) Universal frame for mounting frames and plates with 3/4 modules with Italian standard of any manufacturer, with a maximum size of the insertable plate of 142x86 mm; 2) Vertical self-supporting frame for snap-fit assembly of Italian or French standard sockets; 3) Self-supporting flat frame for mounting 45x45 mm French standard sockets (standard suitable for the foreign market only).