

Sistemi e componenti per impianti di condizionamento
Components and accessories for conditioning systems





Catalogo generale



Listino prezzi figurato



Catalogo sonde passacavo



Catalogo passerelle a filo in acciaio



Catalogo passerelle in Pvc M1



Catalogo sistemi parafulmine



Catalogo scaricatori di sovratensione



Catalogo canali passacavo carrabili



Catalogo climatizzazione



KLIMADUCT

6

Sistemi di canalizzazione ed accessori
Trunking systems and accessories



KLIMAWATER

14

Componenti per scarico condensa
Components for condensate discharge



KLIMAFIX

26

Staffe e supporti per unità esterne
Brackets and supports for external units



KLIMALINE

34

Tubi, raccordi e utensili
Pipes, connectors and tools



KLIMATOOL

40

Attrezzature per il vuoto e la carica
Equipments for vacuum and charging



KLIMACARE

52

Sistemi di lavaggio e pulitori
Washing systems and cleaners



La nostra esperienza al servizio del cliente

Arnocanali è una realtà giovane e dinamica, è stata fondata nel 1979 ed ha oltre 40 anni di esperienza nella progettazione e costruzione di componenti per la connessione in bassa tensione e di materiale da installazione, sia nel settore civile che in quello industriale.

Ha assunto negli anni una posizione di assoluto rilievo sia nel mercato Italiano che in quello Mondiale. La continua ricerca di nuovi prodotti, volta a risolvere le problematiche dei professionisti, rende Arnocanali una azienda di riferimento.

Il controllo globale dei processi produttivi e della scelta delle materie prime garantisce al prodotto finito un'ottima qualità.

Gli investimenti in nuove tecnologie permettono ad Arnocanali di evadere gli ordini in tempi ridotti e quindi di dare un servizio di prima qualità.

Arnocanali mette a disposizione dei propri clienti un servizio per l'assistenza tecnica e commerciale, fornendo informazioni, tecniche per l'installazione dei prodotti, sulle normative, e sulla reperibilità dei prodotti presso i rivenditori.

La nostra politica aziendale è da sempre icona di Qualità, Servizio ed Innovazione.

Our experience at the service of the customer

Arnocanali is a young and dynamic company, it was founded in 1979 and has over 40 years of experience in the design and construction of components for low voltage connection and installation material, both in the civil and industrial sectors.

Over the years, it has assumed a position of absolute importance both in the Italian and in the world market. The continuous search for new products, aimed at solving the problems of professionals, makes Arnocanali a reference company.

The global control of the production processes and the choice of raw materials guarantees the finished product excellent quality.

Investments in new technologies allow Arnocanali to process orders in a short time and therefore to provide a top quality service.

Arnocanali provides its customers with a service for technical and commercial assistance, providing technical information for the installation of products, on regulations, and on the availability of products at retailers.

Our company policy has always been an icon of Quality, Service and Innovation.



Sito internet www.arnocanali.it

Sul NUOVO sito internet di Arnocanali sarete aggiornati in tempo reale sulle novità presenti o su quelle in uscita. Il nostro sito è uno strumento di lavoro per tutti i professionisti. Al suo interno potrete scaricare tutte le documentazioni operative. Inoltre potrete accedere a tutte le certificazioni, alle dichiarazioni di conformità CE, alle voci di capitolato ed alle schede tecniche.

Area Outlet

Nella prima pagina troverete l'area OUTLET dove potrete acquistare materiale di fine serie a prezzi scontatissimi. Per qualsiasi richiesta contattate ARNOCANALI chiedendo del "Commerciale Amico".

The screenshot displays the Arnocanali website interface. At the top left is the company logo. To the right are social media icons for Facebook, Instagram, LinkedIn, and YouTube, along with certification logos for IQNET and IMQ CERTIFIED ISO 9001. A horizontal navigation menu includes links for Home, Il gruppo, la qualità, i servizi, distribuidori, novità, contatti, and lingua. Below the menu are two large images: a close-up of a white electrical outlet on the left, and a modern interior design studio with mannequins and a computer monitor on the right. A vertical list of product categories is shown on the left side of the main content area, including: canali portacavi, canali industriali, canali carcabili, torrette e colonne, multiprese da scrivania, morsetti e morsettiere, sonde passacavi, isolanti e sigillanti, accessori cavi e tubi, pozzetti e accessori, protezione parafulmine, and climatizzazione. On the right side, there are four service area tiles: 'blog aziendale' with an image of a person at a computer, 'area riservata' with a 'B2B' graphic, 'voci di capitolato' with an image of a team meeting, and 'area download' with an image of technical documents.

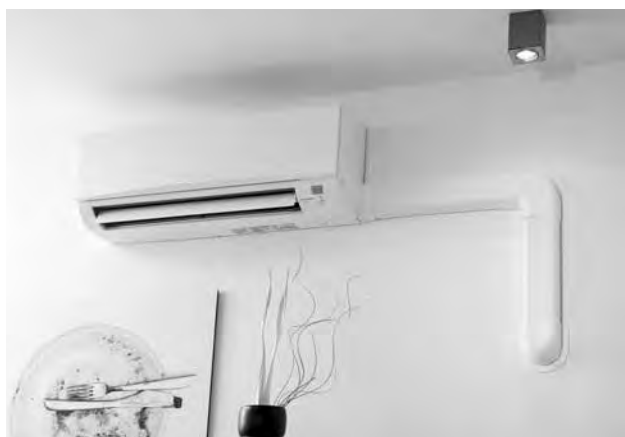
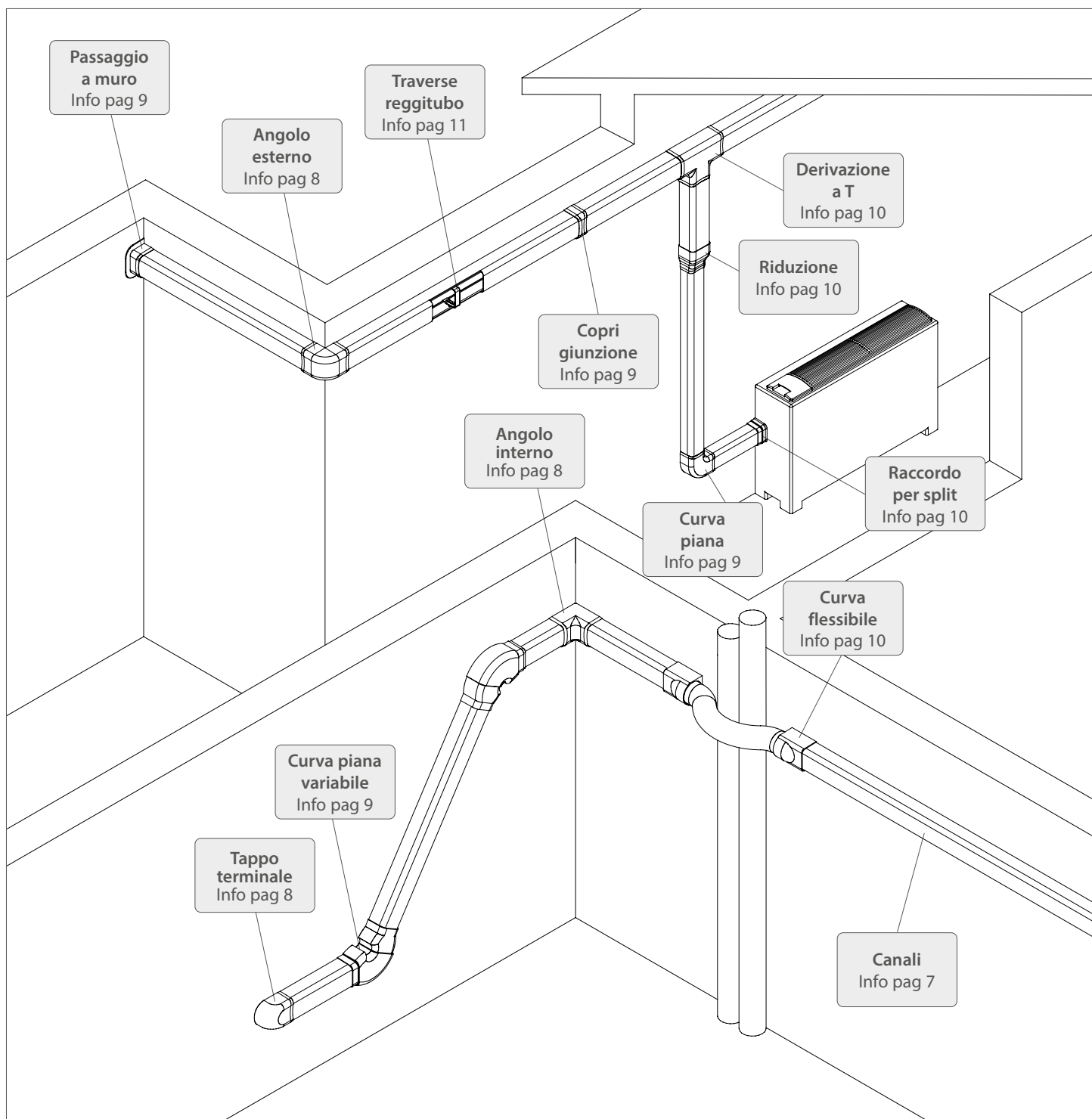

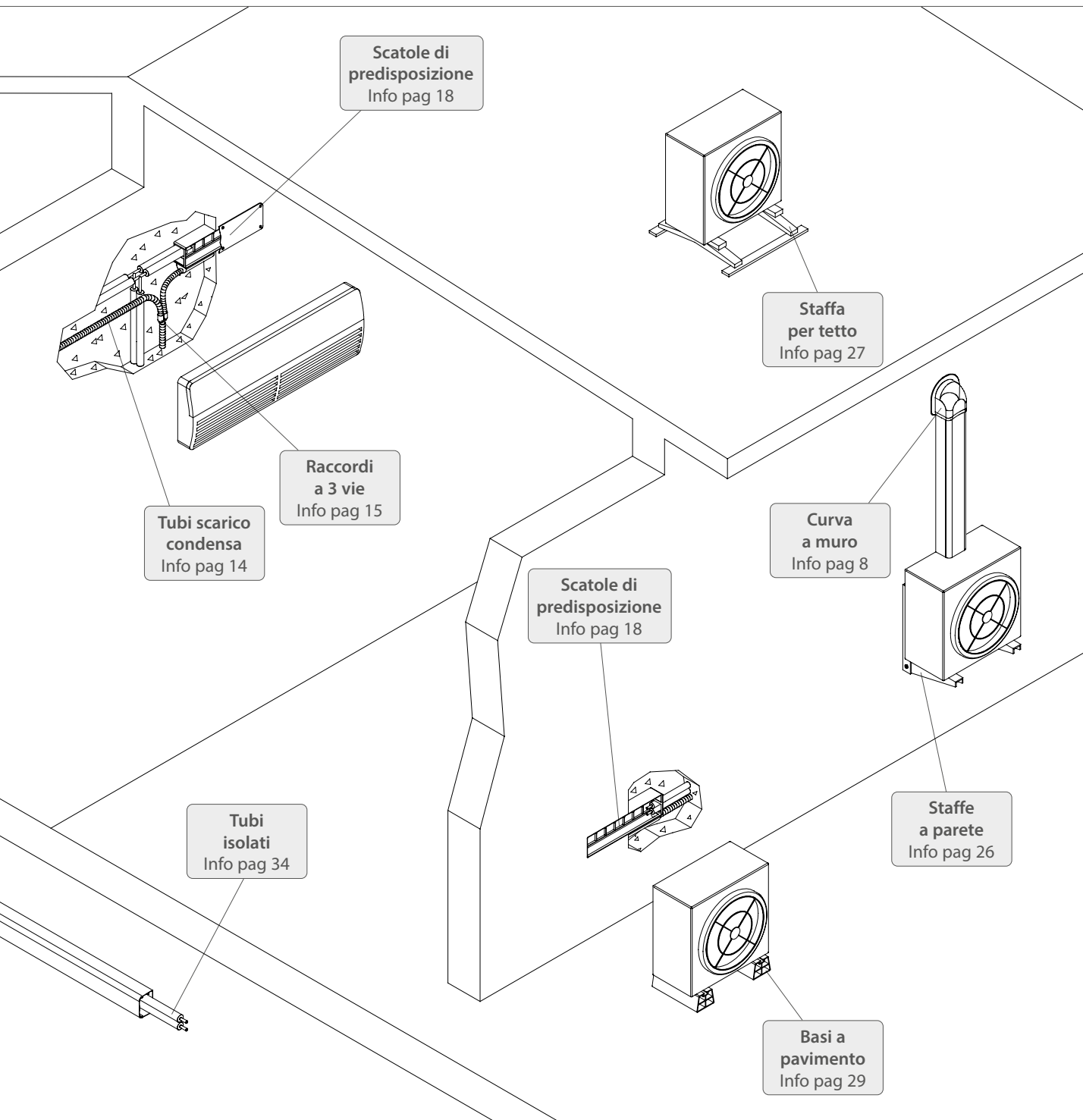



Canali con passanti sul fondo per inserimento fascette

Alcuni canali NKU e NK della linea Klima sono forniti con un sistema di passanti sul fondo del canale. Questi passanti permettono l'introduzione di fascette per il fissaggio dei tubi e dei cavi



Ducts with loops holder on the bottom to insert ties

Some of the Klima trunkings NKU and NK are supplied with loops holder on the bottom of the ducts. These loops allows the introduction of cable ties to fix pipes and cables

Caratteristiche tecniche Technical features

Certificazioni Approval	IMQ CEI UN 5006600	
Direttiva ROHS Complied to ROHS	Conforme Conform	
Resistenza all'urto Mechanical protection	5 Joule	
Protezione UV UV protection	SI YES	
Temperatura d'esercizio Working temperature	- 20 °C + 60 °C	
Colore Colour	Bianco RAL 9010 White RAL 9010	
Lunghezza canale Duct length	2 m	
Materiale canale Ducts material	PVC autoestinguente Self-extinguish PVC	

Imballaggio accessori Accessories packaging

Gli accessori dei canali della linea KLIMA sono disponibili in 2 versioni di packaging:

Imbustata: questa versione è imballata in bustine di polietilene e a sua volta in scatole di cartone, per mantenere l'accessorio protetto da sporcizia e invecchiamento precoce.

Standard: questa versione è imballata direttamente nelle scatole di cartone e il prezzo è più basso.

The accessories of the KLIMA trunkings are available in 2 packaging versions:

Plastic bag: this version is packed in plastic bags and then in carton boxes, to maintain the piece protected from dirty and premature aging.

Standard: this version is packed simply in carton boxes and is offered to a lower price.

Canale con coperchio a U e passanti sul fondo
Trunking with U cover and loops on the bottom

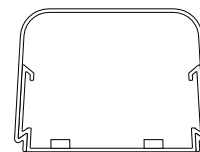

Articolo/imballo Item/packing	NKU5065.3 24 m	NKU6080.3 24 m	NKU6590.3 24 m	
Dimensioni bxh Dimensions bxh	65 x 50 mm	80 x 60 mm	90 x 65 mm	
File passanti Loops row	2	2	3	



Canale con coperchio a U
Trunking with U cover

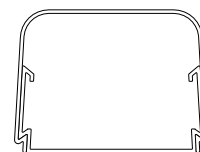

Articolo/imballo Item/packing	NKZ5065.3 24 m	NKZ6080.3 24 m	NKZ6590.3 24 m	NKU75125.3 8 m
Dimensioni bxh Dimensions bxh	65 x 50 mm	80 x 60 mm	90 x 65 mm	125 x 75 mm



Canale con coperchio e passanti sul fondo
Trunking with cover and loops on the bottom

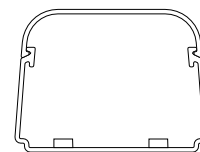

Articolo/imballo Item/packing	NK5065.3 24 m	NK6080.3 16 m	NK6590.3 16 m	NK75125.3 12 m
Dimensioni bxh Dimensions bxh	65 x 50 mm	80 x 60 mm	90 x 65 mm	125 x 75 mm
File passanti Loops row	2	senza passanti without loops	3	3



Curva a muro

Wall bend

Articolo/imballo Item/packing	NSM5065.3 10 p	NSM6080.3 10 p	NSM6590.3 10 p	NKM75125.3 10 p
Articolo imbustato Bag enveloped item	NKM5065.3 10 p	NKM6080.3 10 p	NKM6590.3 10 p	
Per canali For ducts	65 x 50 mm	80 x 60 mm	90 x 65 mm	125 x 75 mm



Tappo terminale

End piece

Articolo/imballo Item/packing	NSE5065.3 10 p	NSE6080.3 10 p	NSE6590.3 10 p	NKE75125.3 10 p
Articolo imbustato Bag enveloped item	NKE5065.3 10 p	NKE6080.3 10 p	NKE6590.3 10 p	
Per canali For ducts	65 x 50 mm	80 x 60 mm	90 x 65 mm	125 x 75 mm



Angolo interno

Internal angle

Articolo/imballo Item/packing	NSI5065.3 10 p	NSI6080.3 10 p	NSI6590.3 10 p	NKI75125.3 10 p
Articolo imbustato Bag enveloped item	NKI5065.3 10 p	NKI6080.3 10 p	NKI6590.3 10 p	
Per canali For ducts	65 x 50 mm	80 x 60 mm	90 x 65 mm	125 x 75 mm



Angolo esterno

External angle

Articolo/imballo Item/packing	NSA5065.3 10 p	NSA6080.3 10 p	NSA6590.3 10 p	NKA75125.3 10 p
Articolo imbustato Bag enveloped item	NKA5065.3 10 p	NKA6080.3 10 p	NKA6590.3 10 p	
Per canali For ducts	65 x 50 mm	80 x 60 mm	90 x 65 mm	125 x 75 mm



Curva piana
Flat angle

Articolo/imballo Item/packing	NSW5065.3 10 p	NSW6080.3 10 p	NSW6590.3 10 p	NKW75125.3 10 p
Articolo imbustato Bag enveloped item	NKW5065.3 10 p	NKW6080.3 10 p	NKW6590.3 10 p	
Per canali For ducts	65 x 50 mm	80 x 60 mm	90 x 65 mm	125 x 75 mm



Curva piana variabile da 45° a 135°
Variable flat angle from 45° to 135°

Articolo imbustato e imballo Bag enveloped item and packing	NKW5065V.3 5 p	NKW6080V.3 5 p	NKW6590V.3 5 p	
Per canali For ducts	65 x 50 mm	80 x 60 mm	90 x 65 mm	



Passaggio a muro
Wall duct

Articolo/imballo Item/packing	NSP5065.3 10 p	NSP6080.3 10 p	NSP6590.3 10 p	NKP75125.3 10 p
Articolo imbustato Bag enveloped item	NKP5065.3 10 p	NKP6080.3 10 p	NKP6590.3 10 p	
Per canali For ducts	65 x 50 mm	80 x 60 mm	90 x 65 mm	125 x 75 mm



Coprigiunzione
Cover joint

Articolo/imballo Item/packing	NSV5065.3 10 p	NSV6080.3 10 p	NSV6590.3 10 p	NKV75125.3 10 p
Articolo imbustato Bag enveloped item	NKV5065.3 10 p	NKV6080.3 10 p	NKV6590.3 10 p	
Per canali For ducts	65 x 50 mm	80 x 60 mm	90 x 65 mm	125 x 75 mm



Curva flessibile
Flexible bend

Articolo imbustato e imballo Bag enveloped item and packing	NKC5065.3 5 p	NKC6080.3 5 p	NKC6590.3 5 p	NKC75125.3 1 p
Per canali For ducts	65 x 50 mm	80 x 60 mm	90 x 65 mm	125 x 75 mm



Derivazione a T
T-derivation

Articolo/imballo Item/packing	NST5065.3 8 p	NST6080.3 8 p	NST6590.3 6 p	NKT75125.3 6 p
Articolo imbustato Bag enveloped item	NKT5065.3 5 p	NKT6080.3 5 p	NKT6590.3 4 p	
Per canali For ducts	65 x 50 mm	80 x 60 mm	90 x 65 mm	125 x 75 mm



Riduzione (Utilizzabile con derivazione a T)
Reduction (Usable with T-derivation)

Articolo/imballo Item/packing			NKR80-125.3 5 p	NKR90-125.3 5 p
Articolo imbustato Bag enveloped item	NKR65-80.3 10 p	NKR65-90.3 5 p		
Per canali For ducts	65 x 50 mm 80 x 60 mm	65 x 50 mm 90 x 65 mm	80 x 60 mm 125 x 75 mm	90 x 65 mm 125 x 75 mm



Raccordo per split, con guarnizione in gomma
Split connection, with rubber seal

Articolo/imballo Item/packing			NKS6590.3 5 p
Articolo imbustato Bag enveloped item	NKS5065.3 5 p	NKS6080.3 5 p	
Per canali For ducts	65 x 50 mm	80 x 60 mm	90 x 65 mm

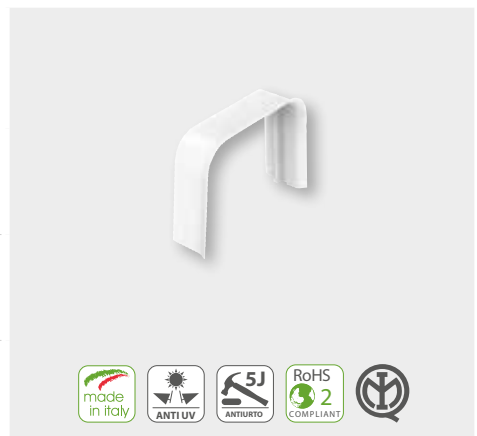

Traverse reggitubo
Pipe clamps

Articolo imbustato e imballo Bag enveloped item and packing	NKTR65-BL 20 p	NKTR80-BL 20 p	NKTR90-BL 20 p	NKTR125 10 p
Per canali For ducts	65 x 50 mm	80 x 60 mm	90 x 65 mm	125 x 75 mm

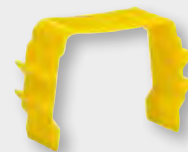

Scatola di derivazione o per installazione minipompa
Derivation box or for installation of mini drain pump

Articolo imbustato Bag enveloped item	6700.3 20 p	6701.3 6 p	6702.3 6 p
Dimensioni Dimensions	115 x 115 x H50 mm	155 x 155 x H80 mm	200 x 200 x H80 mm



Cesoie professionali per taglio canali
Professional cutting tool for ducts

Articolo/imballo Item/packing	NTC 1 p
Lama di ricambio Replacement blade	NTCL 1 p



I canali devono essere tagliati separando la base e il coperchio.
The trunkings must be cutted with cover and base separately.

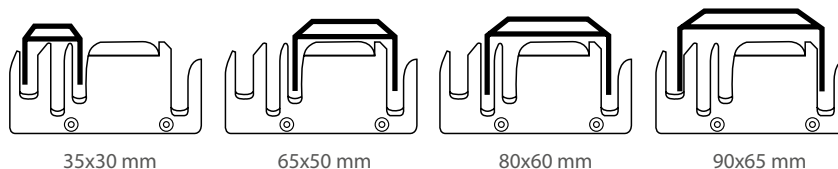

Canale per tubo scarico condensa
Trunking for condensation discharge pipe

Articolo/imballo Item/packing	NK3035.3 32 m
Per tubi For pipes	Ø 16-18 mm Ø 17-20 mm
Dimensioni BxH Dimensions BxH	35 x 30 mm



Angolo interno
Internal angle

Articolo/imballo Item/packing	NKI3035.3 5 p
Dimensioni BxH Dimensions BxH	35 x 30 mm



Angolo esterno
External angle

Articolo/imballo Item/packing	NKA3035.3 5 p
Dimensioni BxH Dimensions BxH	35 x 30 mm

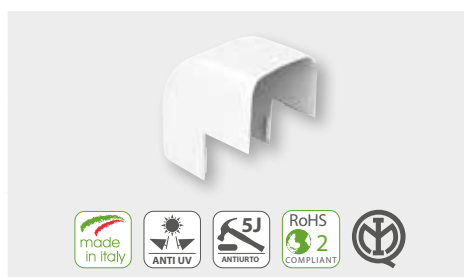

Curva piana
Flat angle

Articolo/imballo Item/packing	NKW3035.3 5 p
Dimensioni BxH Dimensions BxH	35 x 30 mm



Tappo terminale
End piece

Articolo/imballo Item/packing	NKE3035.3 5 p
Dimensioni BxH Dimensions BxH	35 x 30 mm



Coprigiunzione
Cover joint

Articolo/imballo Item/packing	NKV3035.3 10 p
Dimensioni BxH Dimensions BxH	35 x 30 mm

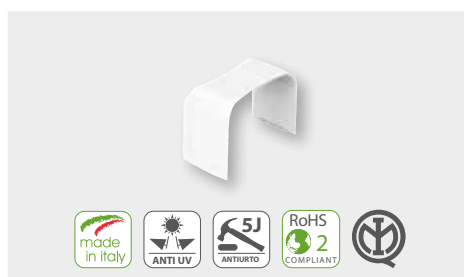

Canale angolare per tubo scarico condensa
Corner trunking for discharge pipe

Articolo/imballo Item/packing	EDK3035.3 38 m	EDK4050.3 20 m
Per tubi For pipes	Ø 16-18 mm	Ø 17-20 mm
Dimensioni Dimensions	30x30x35 mm	40x40x50 mm



Angolo interno e derivazione a T
Internal angle and T-derivation

Articolo/imballo Item/packing	EDKI35.3 10 p	EDKI50.3 10 p
Dimensioni Dimensions	30x30x35 mm	40x40x50 mm

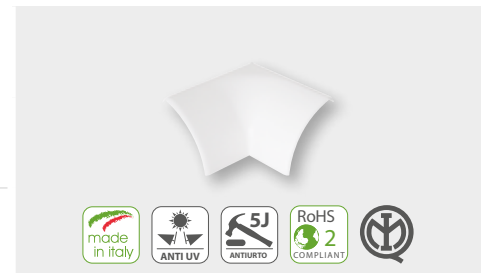

Angolo esterno
External angle

Articolo/imballo Item/packing	EDKA35.3 10 p	EDKA50.3 10 p
Dimensioni Dimensions	30x30x35 mm	40x40x50 mm



Tappo terminale
End piece

Articolo/imballo Item/packing	EDKE35.3 10 p	EDKE50.3 10 p
Dimensioni Dimensions	30x30x35 mm	40x40x50 mm



Coprigiunzione
Cover joint

Articolo/imballo Item/packing	KPV35.3 10 p	KPV50.3 10 p
Dimensioni Dimensions	30x30x35 mm	40x40x50 mm



Cesoie professionali per taglio canali
Professional cutting tool for ducts

Articolo/imballo Item/packing	NTC 1 p	
Per canali For ducts	35x30 mm - 65x50 mm 80x60 mm - 90x65 mm	



Tubi ed accessori per scarico condensa Pipes and accessories for water condensation discharge



Tubo corrugato - Corrugated pipe

Descrizione Description	BIESTRUSO antischiacciamento. Ogni metro dispone di 2 giunzioni maschio, 2 giunzioni femmina e 10 guarnizioni per ogni rotolo da 50 metri. Tubo costruito con Polipropilene stabilizzato contro i raggi UV. Temperatura d'esercizio - 30°C + 75°C Anti-crashing corrugated BIEXTRUDED pipe. Every meter 2 male junctions, 2 female junctions and 10 O-ring each roll of 50 m. The pipe is produced with Polypropylene stabilized against UV rays. Operating temperature - 30°C + 75°C.			
Articolo/imballo Item/packing	NTD16-18 50 m	NTD16-18.10 10 m	NTD17-20 50 m	NTD17-20.10 10 m
Dimensioni Dimensions	Ø 16-18 mm	Ø 16-18 mm	Ø 17-20 mm	Ø 17-20 mm

Descrizione Description	BIESTRUSO antischiacciamento. Ogni metro dispone di 2 giunzioni maschio, 2 giunzioni femmina SENZA guarnizioni. Tubo costruito con Polipropilene stabilizzato contro i raggi UV. Temperatura d'esercizio - 30°C + 75°C Anti-crashing corrugated BIEXTRUDED pipe. Every meter 2 male junctions, 2 female junctions WITHOUT O-rings. The pipe is produced with Polypropylene stabilized against UV rays. Operating temperature - 30°C + 75°C.			
Articolo/imballo Item/packing	NTD16-20 50 m			
Dimensioni Dimensions	Ø 16-18-20 mm			

Descrizione Description	Antischiacciamento. Ogni metro dispone di 2 giunzioni maschio, 2 giunzioni femmina e 10 guarnizioni per ogni rotolo da 50 metri. Tubo costruito con Polipropilene stabilizzato contro i raggi UV. Temperatura d'esercizio - 30°C + 75°C Anti-crashing corrugated pipe. Every meter 2 male junctions, 2 female junctions and 10 O-ring each roll of 50 m. The pipe is produced with Polypropylene stabilized against UV rays. Operating temperature - 30°C + 75°C.			
Articolo/imballo Item/packing	NTC16-18 50 m		NTC17-20 50 m	
Dimensioni Dimensions	Ø 16-18 mm		Ø 17-20 mm	

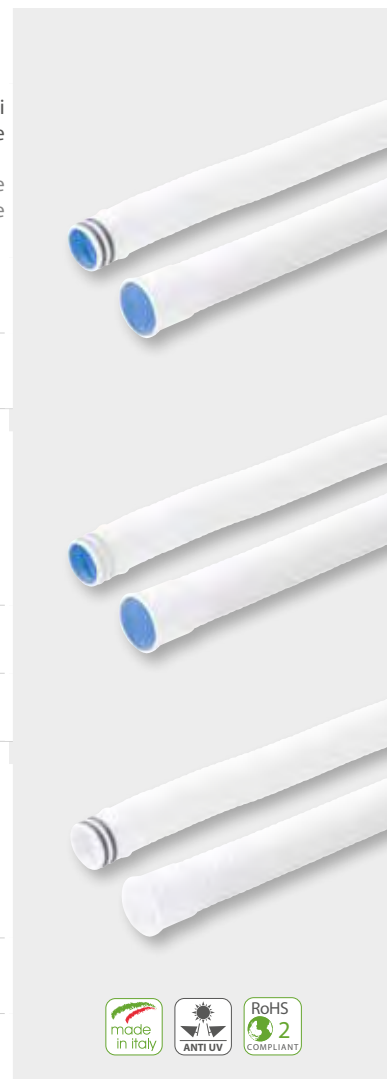

NOVITÀ = NEW

Raccordo centrale a 3 vie
3 way central connector

Articolo/imballo Item/packing	NY18 25 p	NY20 25 p
Dimensioni Dimensions	Ø 16-18 mm	Ø 17-20 mm



Raccordo laterale a 3 vie
3 way lateral connector

Articolo/imballo Item/packing	NYL18 25 p	NYL20 25 p
Dimensioni Dimensions	Ø 16-18 mm	Ø 17-20 mm



Raccordo a T a 3 vie
3 way T connector

Articolo/imballo Item/packing	NYT18 25 p	NYT20 25 p
Dimensioni Dimensions	Ø 16-18 mm	Ø 17-20 mm



Raccordo tra tubo flessibile e tubo rigido
Connecting joint for flexible and rigid pipe

Articolo/imballo Item/packing	NMG20-20 10 p
Dimensioni Dimensions	Ø 20-20 mm



Manicotto di riparazione
Hose repair sleeve

Articolo/imballo Item/packing	NMR20-20 10 p
Dimensioni Dimensions	Ø 20 mm



Raccordo adattatore
Adapter fitting

Articolo/imballo Item/packing	NAD16 10 p	NAD18 10 p	NAD20 10 p
Dimensioni Dimensions	F Ø 16 mm M Ø 14/20 mm	F Ø 18 mm M Ø 14/20 mm	F Ø 20 mm M Ø 14/20 mm



Tubo spiralato con interno liscio
Spiraled pipe with smooth internal

Articolo/imballo Item/packing	NGS16 30 m	NGS20 30 m
Utilizzo Usable	In esterno - In canale External - Ducts	
Dimensioni Dimensions	Ø 16 mm	Ø 20 mm

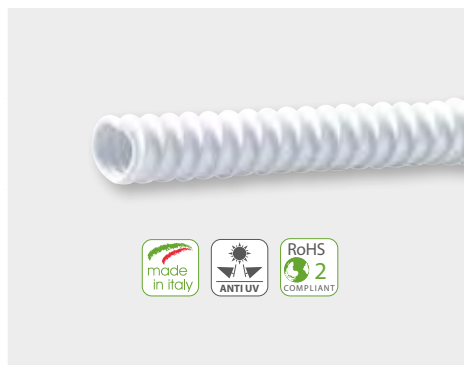

Raccordo centrale a 3 vie
3 way central connector

Articolo/imballo Item/packing	NRY16 25 p	NRY20 25 p
Dimensioni Dimensions	Ø 16 mm	Ø 20 mm



Manicotto di giunzione
Junction connector

Articolo/imballo Item/packing	NMG16 25 p	NMG20 25 p	NMG16-20 25 p
Dimensioni Dimensions	Ø 16 mm	Ø 20 mm	Ø 16-20 mm



Raccordo a 3 vie
3 way connector

Articolo/imballo Item/packing	NGT16BL 25 p	NGT20BL 25 p	NGY16BL 25 p	NGY20BL 25 p
Dimensioni Dimensions	Ø 16 mm	Ø 20 mm	Ø 16 mm	Ø 20 mm



Colla per tubo e raccordi
Glue for pipes and connectors

Articolo/imballo Item/packing	NCOLL 1 p
Quantità Quantity	125 gr



Raccordo tra scatole di predisposizione e tubo
Connector for embedded boxes and pipe

Articolo/imballo Item/packing	RGT16 10 p	RGT20 10 p
Dimensioni Dimensions	Ø 16 mm	Ø 20 mm



Tubo rigido
Rigid pipe

Articolo/imballo
Item/packing

NTR20
60 m

Utilizzo
Usable

In esterno
External

Dimensioni
Dimensions

Ø 20 mm



Manicotto di giunzione
Junction connector

Articolo/imballo
Item/packing

NG20
30 p

Dimensioni
Dimensions

Ø 20 mm



Curva a 90°
90° bend

Articolo/imballo
Item/packing

NC90-20
10 p

Dimensioni
Dimensions

Ø 20 mm



Curva a 45°
45° bend

Articolo/imballo
Item/packing

NC45-20
10 p

Dimensioni
Dimensions

Ø 20 mm



Raccordo a T
T-connector

Articolo/imballo
Item/packing

NT20
5 p

Dimensioni
Dimensions

Ø 20 mm



Fissatubo
Pipe holder

Articolo/imballo
Item/packing

NS20
100 p

NS0832
100 p

Dimensioni
Dimensions

Clip U - U Clip
Ø 20 mm

Fascetta - Cable tie
Ø 8-32 mm

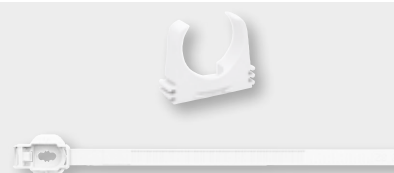



Scatole di predisposizione con vaschetta per scarico condensa
Embedded box for water condensation discharge

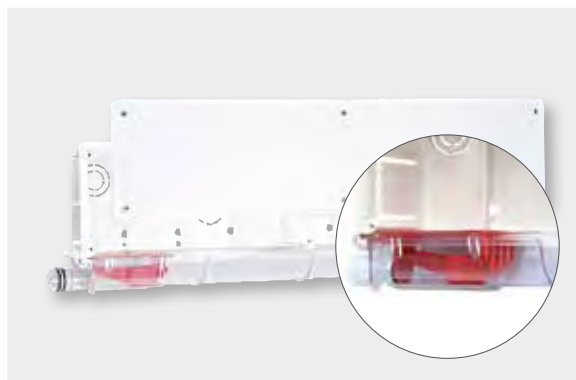

Articolo/imballo Item/packing	NBOX2 24 p	NBOX2S 24 p
Dimensioni Dimensions	A = 430 mm B = 130 mm C = 65 mm	A = 430 mm B = 130 mm C = 65 mm
Tipo vaschetta Tray type	2 uscite presfondabili 2 precutted outputs	2 uscite presfondabili, con SIFONE 2 precutted outputs, with SIPHON
Uscita vaschetta Tray output	Ø 17-20 mm, adattatore per Ø 16-18 mm Ø 17-20 mm, adapter for Ø 16-18 mm	Ø 17-20 mm, adattatore per Ø 16-18 mm Ø 17-20 mm, adapter for Ø 16-18 mm
Utilizzo Usable	Da incasso Embedded	Da incasso Embedded

Vantaggi delle scatole di predisposizione NBOX
Advantages of the embedded boxes NBOX



Fissaggio del coperchio con viti in dotazione
Cover fixing with included screws

Cartoncino paramalta di protezione incluso
Included plastering protection

Raccordo per tubo con guarnizioni in dotazione
Sealing rings for pipe included

Piedini di appoggio per una installazione in bolla
Support pins for a perfect installation



Scatole di predisposizione con vaschetta per scarico condensa
Embedded box for water condensation discharge



Articolo/imballo Item/packing	NBOX1 20 p	NBOX1C 24 p
Dimensioni Dimensions	A = 380 mm B = 120 mm C = 55 mm	A = 485 mm B = 125 mm C = 60 mm
Tipo vaschetta Tray type	1 uscita reversibile 1 reversible output	1 uscita reversibile 1 reversible output
Uscita vaschetta Tray output	Ø 17-20 mm, adattatore per Ø 16-18 mm Ø 17-20 mm, adapter for Ø 16-18 mm	Ø 17-20 mm, adattatore per Ø 16-18 mm Ø 17-20 mm, adapter for Ø 16-18 mm
Utilizzo Usable	Da incasso, adatte per pareti in cartongesso Embedded, usable for plasterboards	Da incasso Embedded

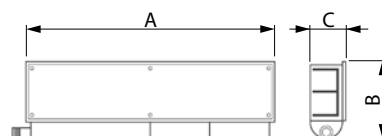
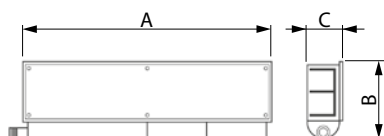

Scatola di predisposizione
Embedded box

Articolo/imballo Item/packing	NBOX 8 p	
Dimensioni Dimensions	A = 430 mm B = 110 mm C = 65 mm	

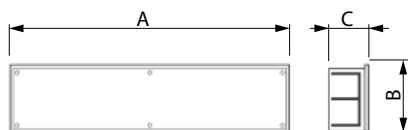

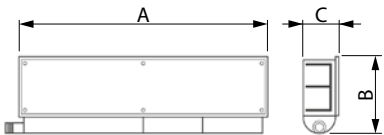

Scatole di predisposizione con vaschetta per scarico condensa
Embedded box for water condensation discharge

Articolo/imballo Item/packing	NBOX2E 24 p
Dimensioni Dimensions	A = 428 mm B = 128 mm C = 70 mm 
Tipo vaschetta Tray type	1 uscita reversibile 1 reversible output
Uscita vaschetta Tray output	Ø 17-20 mm, adattatore per Ø 16-18 mm Ø 17-20 mm, adapter for Ø 16-18 mm
Utilizzo Usable	Da incasso Embedded



Coperchi di ricambio
Covers

Articolo/imballo Item/packing	NCR2 15 p	NCR2E 15 p	NCR1E 15 p
Utilizzabili per Usable for	NBOX2 NBOX2S	NBOX2E	NBOX1C



Adattatore 90°
90° adapter

Articolo Item	NX90 10 p
Dimensioni Dimensions	F Ø 20 mm M Ø 16-18-20 mm

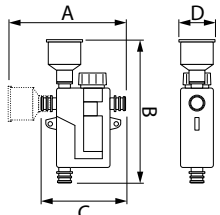

Sifone per installazione verticale e orizzontale
Siphon for vertical and horizontal installation

Articolo/imballo Item/packing	NSO 10 p
Dimensioni Dimensions	<p>A = 163 mm B = 198 mm C = 116 mm D = 52 mm</p> 
Attacchi Connections	<p>IN Ø 20-32 mm OUT Ø 18-20 mm Adattatore - Adapter Ø 20-26-32 mm</p>

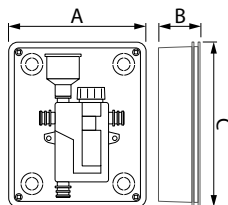

Sifone per installazione verticale e orizzontale, con scatola
Siphon for vertical and horizontal installation, with box

Articolo/imballo Item/packing	NSOC 10 p
Dimensioni Dimensions	<p>A = 204 mm B = 54 mm C = 239 mm</p> 
Attacchi Connections	<p>IN Ø 20-32 mm OUT Ø 18-20 mm Adattatore - Adapter Ø 20-26-32 mm</p>



Sifone per installazione verticale
Siphon for vertical installation

Articolo/imballo Item/packing	NSS 10 p
Attacchi Connections	<p>IN Ø 20-32 mm OUT Ø 18-20 mm</p>





Nebulizzatore di condensa
Condensate nebulizer

Articolo/imballo
Item/packing

NEBCON
1 p

Descrizione
Description

Quando risulta difficile far defluire l'acqua dello scarico condensa o quando si vuole risparmiare la posa di tutti i tubi dello scarico condensa, questo nebulizzatore risolve il problema.

Attaccando il tubo in dotazione direttamente al condizionatore, l'apparecchio raccoglie la condensa e la nebulizza ad intervalli di tempo. Facilissimo da installare e da mettere in funzione.

Portata 0,5 litri ogni 6 minuti, mandata max 50 m, dimensioni scatola 170x13x80 mm, potenza Btu/h: monosplit 24.000, dualsplit 9.000 + 12.000

When it is difficult to drain the water from the condensate drain or when you want to save the installation of all the condensate drain pipes, this nebulizer solves the problem.

By attaching the supplied hose directly to the air conditioner, the appliance collects the condensate and sprays it at intervals of time. Very easy to install and operate.

Flow rate 0,5 litres every 6 minutes, max delivery 50 m, box dimensions 170x13x80 mm, power Btu/h: monosplit 24.000, dualsplit 9.000 + 12.000

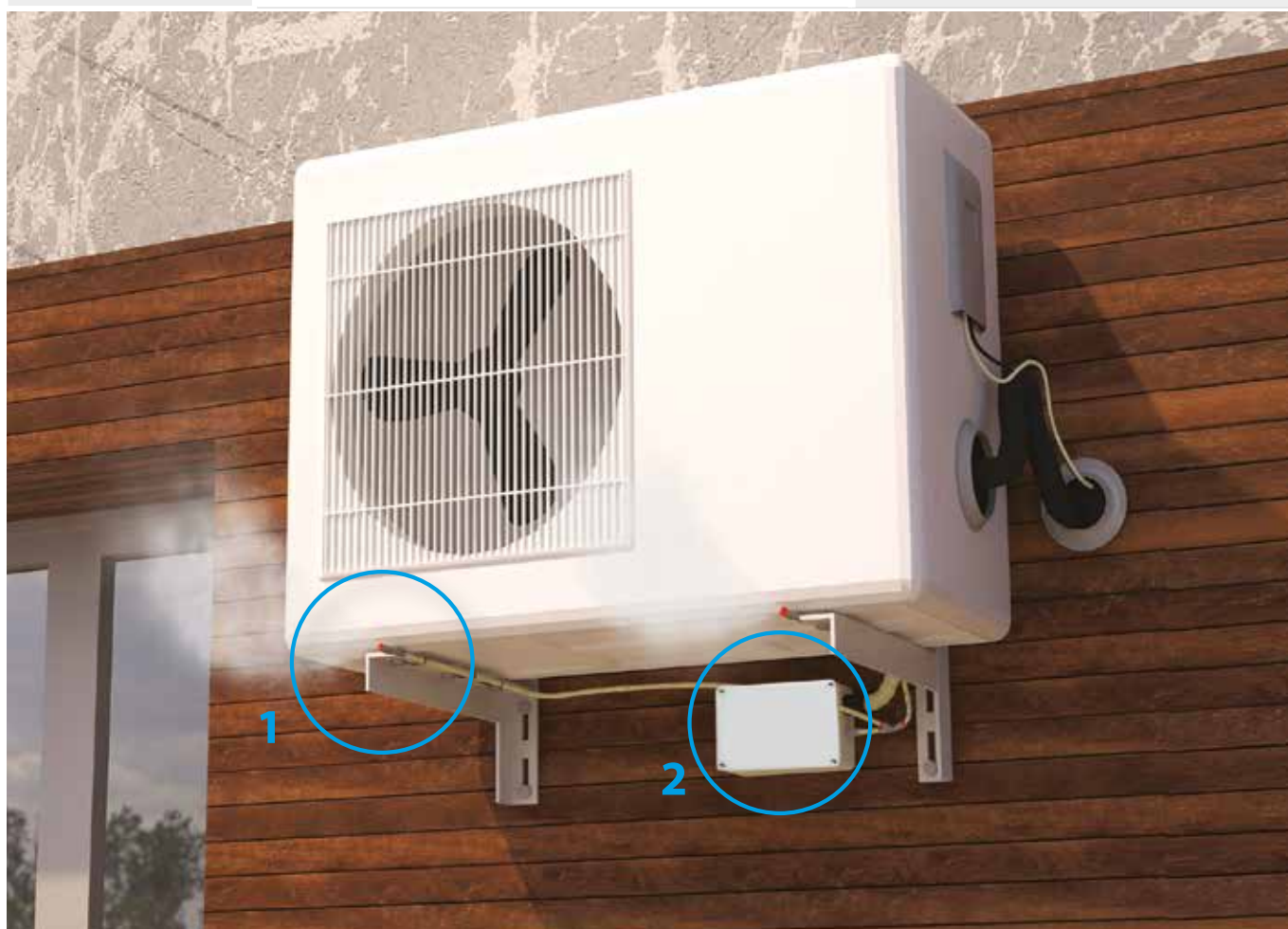
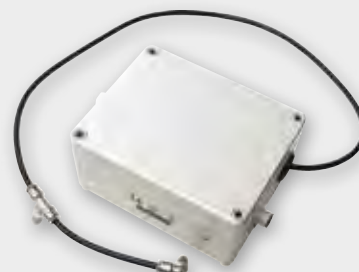

- 1.** Uscita condensa nebulizzata - Nebulized condensate outlet
- 2.** Scatola con apparecchiatura - Box with equipment

Tubo trasparente Ø 6 mm per pompe scarico condensa
Transparent tube Ø 6 mm for mini drain pumps

Articolo/imballo Item/packing	NTT65 1 p	NTT650 1 p
Rotolo da Roll of	5 m	25 m



Raccordi per tubo Ø 6 mm
Fitting pieces for tube Ø 6 mm

Articolo/imballo Item/packing	NGC06 5 p	NGW06 5 p	NTT06 5 p
Tipo Type	I	L	T



Pulitore Biodegradabile in pastiglia per Scarico Condensa
Biodegradable Cleaner in Tablet for Condensate Drain

Articolo/imballo Item/packing	NPSC 1 p
Descrizione Description	<p>Pastiglie specifiche per prevenire la formazione di alghe, mucillaggini e muffe nello scarico condensa dei climatizzatori. Biodegradabili oltre il 99%. Quantità 18 pastiglie</p> <p>Specific tablets to prevent the formation of algae, mucilage and mold in the condensate drain of air conditioners. More than 99% biodegradable. Quantity 18 tablets.</p>



Trattamento Purificante per Interni
Purifying Treatment for Interiors

Articolo/imballo Item/packing	NPT200 24 p
Caratteristiche Characteristics	<p>Per pulire e rinfrescare gli ambienti, lasciando una piacevole sensazione di pulito. L'erogazione delle sue sottili particelle favorisce l'eliminazione di eventuali contaminanti ancora presenti nell'ambiente dopo l'operazione di pulizia degli evaporatori. Vedere pagina 54.</p> <p>To clean and refresh the rooms, leaving a pleasant feeling of cleanliness. The dispensing of its fine particles favors the elimination of any contaminants still present in the environment after the cleaning of the evaporators. See Page 54.</p>



Minipompe per scarico condensa
Mini drain pumps for condensation water



Articolo/imballo Item/packing	NSI2720 1 p	NSI2730 1 p
Prodotti Inclusi Included products	Corpo pompa Pump case Serbatoio di rilevazione Detection sensor Tubo sfiato per rilevatore Breath pipe for sensor Accessori per fissaggio pompa/rilevatore Fixing accessories for pump/sensor	Corpo pompa Pump case Serbatoio di rilevazione Detection sensor Tubo per vaschetta condensa Discharge tray pipe Tubo sfiato per rilevatore Breath pipe for sensor Accessori per fissaggio pompa/rilevatore Fixing accessories for pump/sensor
Dimensioni Pompa e rilevatore Pump dimensions and sensor	Altezza - Height = 28 mm Larghezza - Width = 83 mm Profondità - Depth = 37 mm Altezza - Height = 40 mm Larghezza - Width = 80 mm Profondità - Depth = 40 mm	Altezza - Height = 28 mm Larghezza - Width = 86 mm Profondità - Depth = 48 mm Altezza - Height = 38 mm Larghezza - Width = 75 mm Profondità - Depth = 36 mm
Alimentazione Feeding	220-240V AC - 50/60 Hz	220-240V AC - 50/60 Hz
Protezione termica Thermal protection	SI	SI
Portata massima Max flow rate	15 litri/ora con prevalenza zero 15 liters per hour with head zero	15 litri/ora con prevalenza zero 15 liters per hour with head zero
Allarme Alarm	Senza allarme Without alarm	NA - NA NA - NC
Prevalenza massima Maximal head	12 metri 12 meters	10 metri 10 meters
Aspirazione verticale Vertical suction	2 metri 2 meters	2 metri 2 meters
Livello rumorosità Noise degree	19 dBA 19 dBA	19 dBA 19 dBA
Sezione tubo scarico Drain pipe section	6 mm 6 mm	6 mm 6 mm

Minipompe per scarico condensa
Mini drain pumps for condensation water

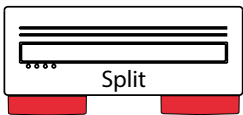
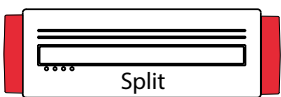

Articolo/imballo Item/packing	NSI2750 1 p	NSPLIT 1 p
Prodotti Inclusi Included products	<p>Corpo pompa Pump case</p> <p>Serbatoio di rilevazione Detection sensor</p> <p>Tubo per vaschetta condensa Discharge tray pipe</p> <p>Tubo sfiato per rilevatore Breath pipe for sensor</p> <p>Accessori per fissaggio pompa/rilevatore Fixing accessories for pump/sensor</p>	<p>Montaggio orizzontale a destra o sinistra Horizontal mounting right or left</p>  <p>Montaggio verticale a destra o sinistra Vertical mounting right or left</p> 
Dimensioni Pompa e rilevatore Pump dimensions and sensor	<p>Altezza - Height = 45 mm</p> <p>Larghezza - Width = 85 mm</p> <p>Profondità - Depth = 30 mm</p> <p>Altezza - Height = 38 mm</p> <p>Larghezza - Width = 75 mm</p> <p>Profondità - Depth = 36 mm</p>	<p>Altezza - Height = 60 mm</p> <p>Larghezza - Width = 230 mm</p> <p>Profondità - Depth = 55 mm</p>
Alimentazione Feeding	220-240V AC - 50/60 Hz	220-240V AC - 50/60 Hz
Protezione termica Thermal protection	SI	SI
Portata massima Max flow rate	13 litri/ora con prevalenza zero 13 liters per hour with head zero	15 litri/ora con prevalenza zero 15 liters per hour with head zero
Allarme Alarm	NC NC	NA NC NA NC
Prevalenza massima Maximal head	10 metri 10 meters	10 metri 10 meters
Aspirazione verticale Vertical suction	1,5 metri 1,5 meters	2 metri 2 meters
Livello rumorosità Noise degree	23 dBA 23 dBA	20 dBA 20 dBAr
Sezione tubo scarico Drain pipe section	6 mm 6 mm	6 mm 6 mm



Staffe, supporti e accessori per unità esterne
Brackets, supports and accessories for external units



Staffa regolabile in acciaio verniciato con polveri epossidiche
Adjustable brackets of steel painted with epoxy powders

Articolo/imballo Item/packing	N080E 1 p	N000E 1 p
Portata certificata Certified load	Max 80 Kg	Max 80 Kg
Certificazione Certification		
Portata collaudata Tested load	Max 240 Kg	Max 240 Kg
Fornita Supplied	Smontata Not assembled	Premontata Pre-assembled
Spessore Thickness	12/10	12/10
	A = 450 mm	A = 450 mm
Dimensioni Dimensions		

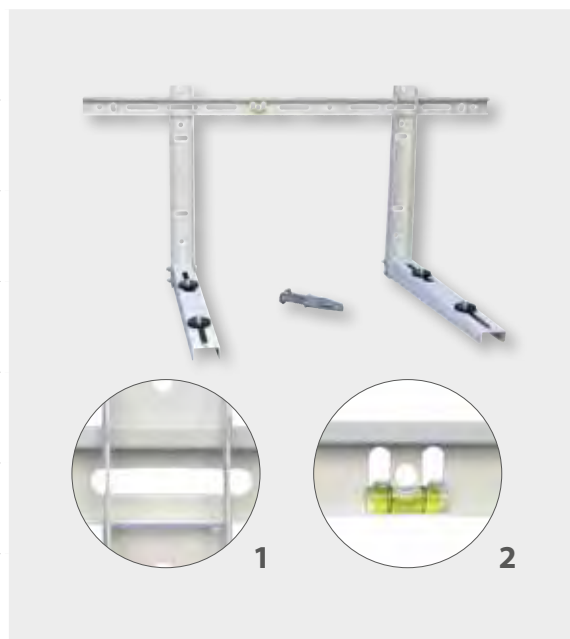

1. Staffa scorrevole, facile e pratica da installare
Sliding bracket, easy and practice to install
2. Livella a bolla, per un fissaggio sicuro
Water level, easily for fixing

Fornite con:
Supplied with:
vibrazione-dampening, fixing screws and water level



Staffa regolabile in acciaio zincato e verniciato con polveri epossidiche
Adjustable brackets of pre-galvanized steel and painted with epoxy powders

Articolo/imballo Item/packing	N001E 1 p	N002E 1 p	N003E 1 p
Portata certificata Certified load	Max 140 Kg	Max 140 Kg	Max 140 Kg
Certificazione Certification			
Portata collaudata Tested load	Max 420 Kg	Max 420 Kg	Max 420 Kg
Spessore Thickness	15/10	15/10	15/10
Dimensioni Dimensions	A = 450 B = 800	A = 500 B = 800	A = 550 B = 1.000

Fornite smontate e con:
piedini antivibranti, viteria di fissaggio e bolla
Supplied not assembled and with:
vibration-damping, fixing screws and water level

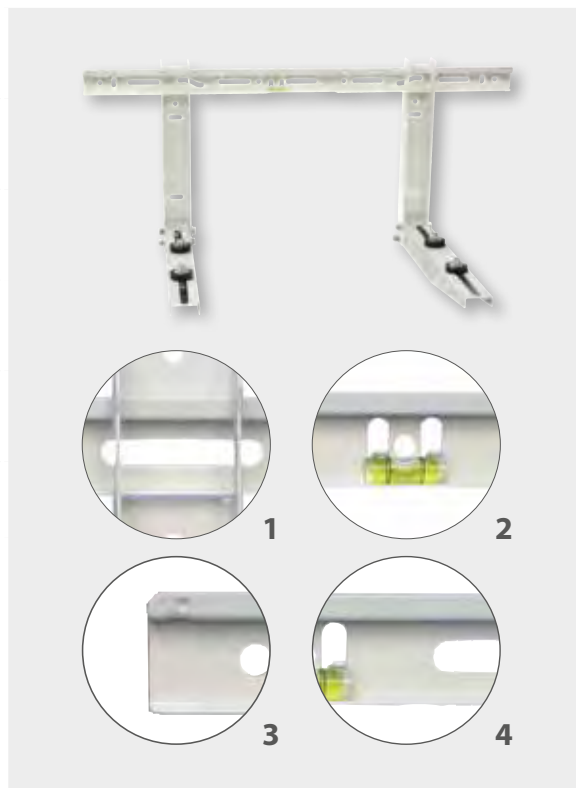

1. Staffa scorrevole, facile e pratica da installare
Sliding bracket, easy and practice to install
2. Livella a bolla, per un fissaggio sicuro
Water level, easily for fixing
3. Punzone fine corsa, per evitare la fuoriuscita laterale
Punch stroke end, to avoid the spillage of the bracket
4. Barra sagomata per inserimento centrale della staffa
Countured bar to insert centrally the bracket



Staffa regolabile per tetto in acciaio verniciato con polveri epossidiche
Adjustable roof brackets of steel painted with epoxy powders

Articolo/imballo Item/packing	N004 1 p	
Portata collaudata Tested load	15° - 80 Kg 25° - 120 Kg	20° - 100 Kg 30° - 150 Kg
Spessore Thickness	15/10	
Dimensioni Dimensions		



Fornite smontate e con:
piedini antivibranti, viteria di fissaggio
Supplied not assembled and with:
vibration-damping, fixing screws



Coppia di staffe in poliammide
Couple of polyamide brackets



Ottima resistenza agli agenti atmosferici e alla salsedine
Excellent resistance to atmospheric agents and saltiness

Articolo/imballo Item/packing	N11 1 p
Portata collaudata Tested load	110 Kg
Dimensioni Dimensions	

Articolo/imballo Item/packing	N100 1 p
Utilizzo Usable	<p>Questa dima in alluminio permette l'installazione ed il posizionamento, fino ad una distanza massima di 1 m, delle staffe articolo N11. Al termine dell'installazione la dima sarà rimossa per essere riutilizzata in successive installazioni. La dima ha una scala graduata e livella a bolla.</p> <p>This template of aluminium allows the installation and positioning, up to a maximum distance of 1 m, of the brackets item N11. At the end of the installation the template must be removed to be used for further installations. The template has a graduated scale and water level.</p>



Coppia di staffe regolabili in acciaio verniciato con polveri epossidiche
Couple of adjustable brackets of steel painted with epoxy powders

Articolo/imballo Item/packing	N021 1 p
Portata certificata Certified load	Max 80 Kg
Certificazione Certification	
Portata collaudata Tested load	Max 240 Kg
Spessore Thickness	12/10
Dimensioni Dimensions	



Fornite smontate e con:
Supplied not assembled and with:
vibration-damping and fixing screws



Base a pavimento in PVC con fasce in gomma adesive e bulloneria di fissaggio
Ground support of PVC with adhesive rubber tapes and fixing screws

Articolo/imballo Item/packing	NBP8350 24 p	NBP8450 24 p	NBP81000 4 p
Portata Load	140 Kg	140 Kg	140 Kg
Dimensioni Dimensions	A = 350 mm B = 80 mm C = 90 mm	A = 450 mm B = 80 mm C = 90 mm	A = 1.000 mm B = 80 mm C = 90 mm

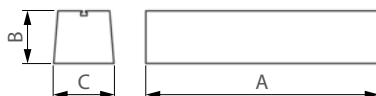

Tappo chiusura
End cap

Articolo/imballo Item/packing	NBPE80 8 p
----------------------------------	----------------------



Base a pavimento in PVC con fasce in gomma coestruse e bulloneria di fissaggio
Ground support of PVC with coextruded rubber tapes and fixing screws

Articolo/imballo Item/packing	NBP10350 14 p	NBP10450 14 p
Portata Load	160 Kg	160 Kg
Dimensioni Dimensions	A = 350 mm B = 100 mm C = 100 mm	A = 450 mm B = 100 mm C = 100 mm

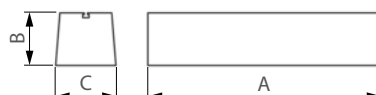

Tappo chiusura
End cap

Articolo/imballo Item/packing	NBPE100 8 p
----------------------------------	-----------------------





Base a pavimento in PP con fasce in gomma adesive e bulloneria di fissaggio
Ground support of PP with adhesive rubber tapes and fixing screws

Articolo/imballo Item/packing	NBP420 30 p
Portata Load	140 Kg
Dimensioni Dimensions	A = 420 mm B = 72 mm C = 120 mm



Basi a pavimento regolabili in altezza
Adjustable floor base block

Articolo/imballo Item/packing	NP4 4 p
Dimensioni Dimensions	Ø 100 mm
Altezza variabile Variable height	90 / 140 mm
Portata Load	MAX 325 Kg



Chiave per regolazione altezza
Height adjustment wrench

Articolo/imballo Item/packing	NP4C 1 p
----------------------------------	--------------------



Basi a pavimento fisse
Fixed floor base block

Articolo/imballo Item/packing	NP4F 4 p
Dimensioni Dimensions	Ø 100 mm
Altezza Height	90 mm
Portata Load	MAX 325 Kg



Kit piedini antivibranti per staffe e basi
Antivibration dampers for brackets/supports

Articolo/imballo Item/packing	NS2030 25 p	NS4040 20 p
Dimensioni Dimensions	Ø 30 x 20 mm M8	Ø 40 x 40 mm M8
Portata Load	50 Kg x 1	100 Kg x 1



Kit piedini antivibranti per staffe e basi
Antivibration dampers for brackets/supports

Articolo/imballo Item/packing	NS2040 25 p
Dimensioni Dimensions	Ø 40 x 20 mm M8
Portata Load	50 Kg x 1



Kit piedini antivibranti per pavimento
Antivibration dampers kit for floor

Articolo/imballo Item/packing	NP4040 20 p
Dimensioni Dimensions	Ø 40 x 40 mm M8
Portata Load	80 Kg x 1



Kit piedini antivibranti per pavimento
Antivibration dampers kit for floor

Articolo/imballo Item/packing	NP2050 25 p
Dimensioni Dimensions	Ø 48 x 20 mm M8
Portata Load	80 Kg x 1



Pettine per alette evaporatori e condensatori
Fin comb for absorber and condenser



Articolo/imballo Item/packing	NPA 5 p	NPE 10 p	NPA6 10 p
Materiale Material	Acciaio INOX Stainless steel	Acciaio INOX Stainless steel	Plastica Plastic

Copertura di protezione per unità esterne Protection box for external units

Montaggio a parete
Wall mounting

Articolo bianco White item	NCW09070.3	NCW10085.3	NCW10595.3
Articolo nero Black item	NCW09070.2	NCW10085.2	NCW10595.2
Dimensioni bxh Dimensions bxh	90x70 cm (Int 82x66)	100x85 cm (Int 92x81)	105x95 cm (Int 97x91)
Profondità Depth	46/52 cm	54/60 cm	59/65 cm

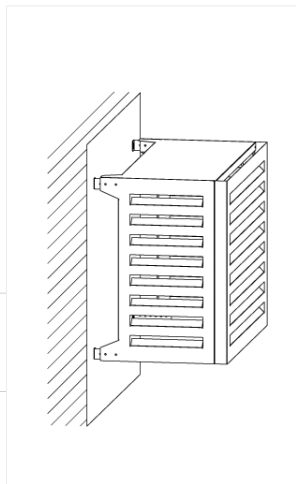

Montaggio a pavimento vicino ad una parete
Floor mounting next to the wall

Articolo bianco White item	NCF09078.3	NCF10093.3	NCF10513.3
Articolo nero Black item	NCF09078.2	NCF10093.2	NCF10513.2
Dimensioni bxh Dimensions bxh	90x78 cm (Int 82x75)	100x93 cm (Int 92x90)	105x103 cm (Int 97x100)
Profondità Depth	46/52 cm	54/60 cm	59/65 cm

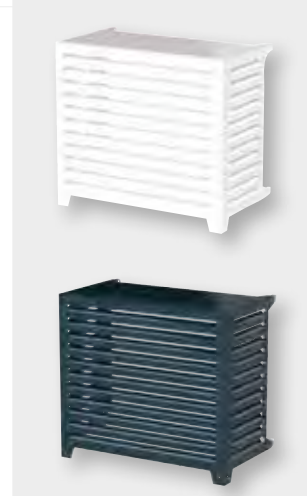
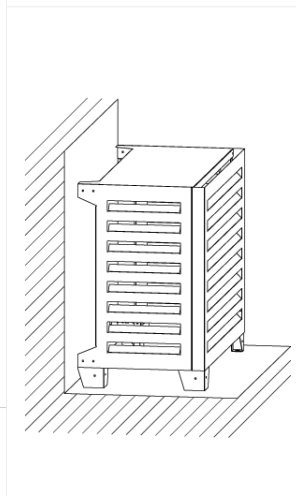

Montaggio a pavimento, su 4 lati ad isola
Floor mounting, for 4 sides freestanding

Articolo bianco White item	NCS09078.3	NCS10093.3	NCS10513.3
Articolo nero Black item	NCS09078.2	NCS10093.2	NCS10513.2
Dimensioni bxh Dimensions bxh	90x78 cm (Int 82x75)	100x93 cm (Int 92x90)	105x103 cm (Int 97x100)
Profondità Depth	51 cm	59 cm	64 cm

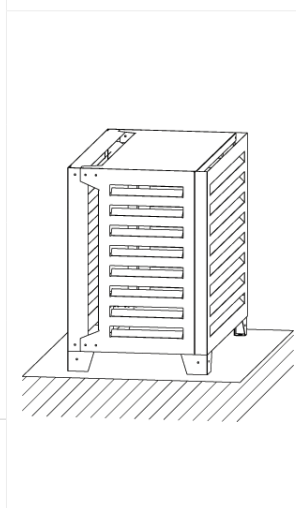

Teli protettivi per unità esterne
Protection cloths for external unit

Articolo/imballo Item/packing	NTM760 10 p	NTM800 10 p	NTM860 10 p	NTM950 10 p
Dimensioni Dimensions	76x56x27 cm	80x60x30 cm	86x70x40 cm	95x85x40 cm



Bacinella raccogli condensa con staffe
Condensate water tray with brackets

Articolo/imballo Item/packing	NBC780 1 p	NBC940 1 p
Dimensioni Dimensions	790x390 mm	940x420 mm



Kit scarico universale con guarnizione e tappo
Universal drain kit with seal and closing cap

Articolo/imballo Item/packing	NSR 1 p	NSR32 1 p
Dimensioni Dimensions	Ø 19 mm	Ø 32 mm



Deflettore di protezione per condizionatori
Air protection deflector conditioner

Articolo/imballo Item/packing	NDEF1 1 p	NDEF2 1 p
Dimensioni Dimensions	790x250 mm	1.030x250 mm

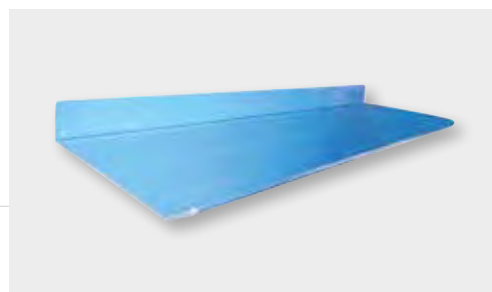

Per deviare il flusso dell'aria condizionata proveniente dagli split, che potrebbe creare disagio alle persone presenti nella stanza
To divert conditioned air flow coming from the splits, that could create unease for the people in the room





Tubi, raccordi e utensili
Pipes, connectors and tools



Tubo isolato in RAME
Insulated copper pipe

Articolo/imballo Item/packing	NTE0114.08 50 m	NTE0238.08 50 m	NTE0312.08 50 m	NTE0114 50 m	NTE0238 50 m	NTE0312 50 m	NTE0458 50 m
Ø Tubo Pipe Ø	1/4"	3/8"	1/2"	1/4"	3/8"	1/2"	5/8"
Pressione d'esercizio Working pressure	0 8 100 bar	0 8 65 bar	0 8 55 bar	0 1 130 bar	0 1 95 bar	0 1 70 bar	0 1 50 bar
Pressione di scoppio Bursting pressure	493,9 bar	329,5 bar	247,0 bar	696,64 bar	471,42 bar	353,38 bar	282,62 bar
Ø Guaina Ø Covering	20 mm	24 mm	30 mm	20 mm	24 mm	30 mm	36 mm
Spessore guaina Covering thickness	6 mm	8 mm	10 mm	6 mm	8 mm	9 mm	10 mm

Uso: per impianti Split R410A, R407C, R422B, R32 - Temperatura di esercizio: -80°C +95°C
 Materiale: Tubo in rame A.C.R. Cu DHP 99,9% con rivestimento in polietilene espanso a cellule chiuse e guaina antistrappo in polietilene a norma EN 13501-1, certificazione EN 12735-1. Permeabilità al vapore: μ 11.000, conforme alla nuova classe di reazione al fuoco europea secondo norma EN 13501-1, Euroclass BLS1d0.

Usage: for split systems R410A, R407C, R422B, R32 - Working temperature: -80°C to +95°C
 Material: Copper pipe A.C.R. Cu DHP 99,9% with covering of closed cells expanded polyethylene and gaiter made up of tearing-resistant polyethylene according to EN 13501-1, certification EN 12735-1. Steam permeability: μ 11.000, complies to the new european class to fire reaction according to norm EN 13501-1, Euroclass BLS1d0.

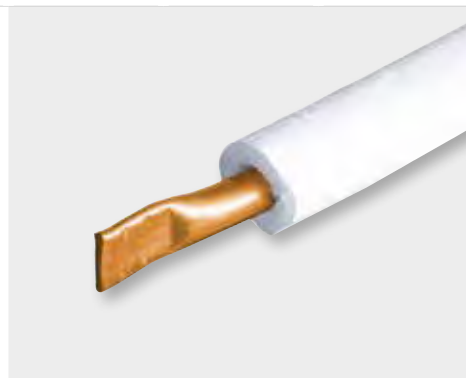

NOVITÀ = NEW

Nastro adesivo
Adhesive tape

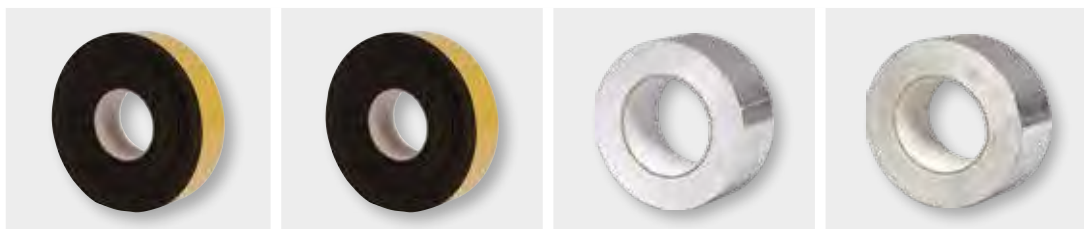

Articolo/imballo Item/packing	NFA 12 p	NFG 12 p	NAL30 5 p	NAR50 8/1 p
Dimensioni Dimensions	50 x 3 mm 10 m	50 x 3 mm 10 m	50 x 0,03 mm 30 m	50 x 0,03 mm 50 m
Materiale Material	Gomma retinata Wired rubber	Gomma Rubber	Alluminio Aluminium	Alluminio retinato Wired Aluminium

Sbavatubo
Reamer



Articolo/imballo Item/packing	NSTP 1 p	NST 6 p	NSTI 5 p
Materiale Material	Alluminio Aluminium	Plastica Plastic	Plastica Plastic

Tagliatubo
Tube cutter



Articolo/imballo Item/packing	NT18580 5 p	NT1858P 5 p	NT18118 10 p
Per tubi For pipes	1/8" ~ 5/8"	1/8" ~ 5/8"	1/8" ~ 1 1/8"
Lama di ricambio Replacement blade	NRR18580 10 p	NRR1858P 10 p	NRR18118 10 p

Tagliatubo professionale
Professional tube cutter

Articolo/imballo Item/packing	NT14158 5 p
Per tubi For pipes	1/4" ~ 1-5/8"
Lama di ricambio Replacement blade	NRR14158 10 p



Flangiatubi eccentrico a cricchetto
Eccentric ratchet flaring tool

Articolo/imballo Item/packing	NF14340C 1 p
Per tubi For pipes	1/4" - 5/16" - 3/8" - 1/2" - 5/8" - 3/4"
Accessori Accessories	Tagliatubo Tube cutter



Flangiatubi
Flaring tool

Articolo/imballo Item/packing	NF14340S 1 p
Per tubi For pipes	1/4" - 5/16" - 3/8" - 1/2" - 5/8" - 3/4"
Accessori Accessories	Tagliatubo e sbavatubo Tube cutter and reamer



Flangiatubi universale
Universal flaring tool

Articolo/imballo Item/packing	NF31658 1 p
Per tubi For pipes	3/16" ~ 5/8"



Olio universale per flange
Universal oil for flare

Articolo/imballo Item/packing	NOLC 9/1 p
Quantità Quantity	100 ml



Piegatubo a cricchetto

Ratchet tube bender

Articolo/imballo Item/packing	NPCU 1 p		
Per tubi For pipes	3/8" - 1/2" - 5/8" - 3/4" - 7/8"		
Accessori Accessories	Tagliatubo e sbavatubo Tube cutter and reamer		

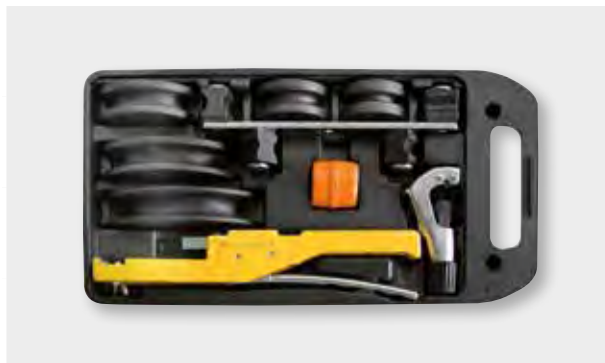

Piegatubo a leva

Ratchet tube bender

Articolo/imballo Item/packing	NPL1438 1 p		
Per tubi For pipes	1/4" - 3/8" - 5/16" Fino - Till 180°		



Allargatubi

Tube expander

Articolo/imballo Item/packing	NTL 1 p		
Per tubi For pipes	3/8" - 1/2" - 5/8" - 3/4" - 7/8" - 1"		
Accessori Accessories	Sbavatubo Reamer		



Molle curvatubo

Spring bender

Articolo/imballo Item/packing	NMC14 1 p	NMC38 1 p	NMC12 1 p	NMC58 1 p
Per tubi For pipes	1/4"	3/8"	1/2"	5/8"
Lunghezza Length	27 cm	35 cm	35 cm	35 cm



Chiavi dinamometriche
Torque wrenches

Articolo/imballo
Item/packing

NSD
1 p

Dimensione chiavi
Wrenches dimension

17mm - 19mm - 22mm
24mm - 26mm - 27 mm

Coppia di serraggio
Tightening torque

10 - 75 Nm



Sigillante per filetti
Thread sealer

Articolo/imballo
Item/packing

NLOC
1 p

Quantità
Quantity

50 ml

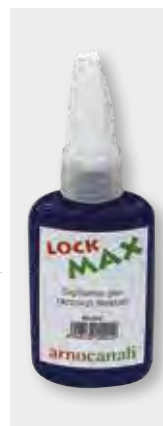

Inversore di flusso
Inverting joint

Articolo/imballo
Item/packing

NIF14
10/1 p

NIF38
10/1 p

NIF12
5/1 p

Per tubi
For pipes

1/4"

3/8"

1/2"



Raccordo di giunzione autocartellante
Self-threading connecting joint

Articolo/imballo
Item/packing

NRA0114BL
20 p

NRA0238BL
20 p

NRA0312BL
10 p

Per tubi
For pipes

1/4"

3/8"

1/2"



Bocchettone autocartellante
Self-threading nut

Articolo/imballo
Item/packing

NA14BL
20 p

NA38BL
20 p

NA12BL
10 p

Per tubi
For pipes

1/4"

3/8"

1/2"

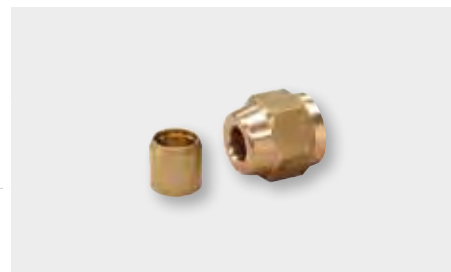

Raccordo di giunzione
Connecting joint

Articolo/imballo
Item/packing

NRG0114
20 p

NRG0238
20 p

NRG0312
10 p

NRG0458
5 p

Per tubi
For pipes

1/4"

3/8"

1/2"

5/8"



Bocchettone
Short nut

Articolo/imballo
Item/packing

NB14
20 p

NB38
20 p

NB12
10 p

NB58
10 p

Per tubi
For pipes

1/4"

3/8"

1/2"

5/8"



Bocchettone ridotto
Reduced flare nut

Articolo/imballo Item/packing	NBR1238BL 10 p	NBR3814 10 p
Da a From to	1/2" - 3/8"	3/8" - 1/4"



Guarnizione in rame
Copper gasket

Articolo/imballo Item/packing	NOR14 10 p	NOR38 10 p	NOR12 10 p	NOR58 10 p
Per tubi For pipes	1/4"	3/8"	1/2"	5/8"



Bocchettone
Short nut

Articolo/imballo Item/packing	NBO14 10 p	NBO38 10 p	NBO12 10 p	NBO58 10 p
Per tubi For pipes	1/4"	3/8"	1/2"	5/8"

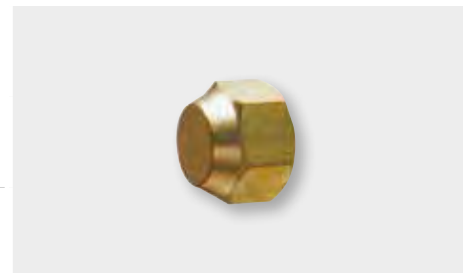

Riduzione maschio - maschio
Reduction male - male

Articolo/imballo Item/packing	NRD1438 10 p	NRD1412 10 p	NRD3812 10 p	NRD3858 10 p
Maschio Male	1/4" - 3/8"	1/4" - 1/2"	3/8" - 1/2"	3/8" - 5/8"



Riduzione maschio - femmina
Reduction male - female

Articolo/imballo Item/packing	NR14-38 10 p	NR14-12 10 p	NR38-14 10 p	NR38-12BL 10 p
Maschio Male	1/4"	1/4"	3/8"	3/8"
Femmina Female	3/8"	1/2"	1/4"	1/2"



Riduzione maschio - femmina
Reduction male - female

Articolo/imballo Item/packing	NR12-14 10 p	NR12-38BL 10 p	NR12-58 10 p	NR58-12 10 p
Maschio Male	1/2"	1/2"	1/2"	5/8"
Femmina Female	1/4"	3/8"	5/8"	1/2"





Attrezzatura per il vuoto, la carica ed il lavaggio
Equipments for vacuum, charging and flushing



Stazione di vuoto e carica
Vacuum and charging kit

71 L/MIN

Articolo/imballo Item/packing	KLIMABOXPRO 1 p
Pompa bistadio 2-stage vacuum pump	71 l/min
Gas utilizzabili Usable gas	R410A - R407C R422B - R134a - R32
Bilancia elettronica Electronic scale	Fino - Till 50 Kg
Supporti per bombole Bottle supports	1 x 1/4" SAE 1 x 5/16" SAE
Manometro Manifold	Digitale universale a 4 vie Universal digital 4 ways
Tubi con rubinetto Ball valve hoses	3 da 150 cm attacco 5/16" SAE 3 of 150 cm connection 5/16" SAE
Valigia Case	In resina con ruote Of plastic with wheels
Dimensioni valigia Case dimensions	600x380x430 mm
Adattatori inclusi Included adapters	1 x M5/16" SAE- F1/4" SAE con depressore, 1 x M5/16" SAE- F1/4" SAE 1 x M5/16" SAE- F1/4" SAE with depressor, 1 x M5/16" SAE- F1/4" SAE





Stazione di vuoto e carica
Vacuum and charging kit

42 L/MIN

Articolo/imballo Item/packing	KLIMABOX 1 p
Pompa bistadio 2-stage vacuum pump	42 l/min
Gas utilizzabili Usable gas	R410A - R32
Bilancia elettronica Electronic scale	Fino - Till 5 Kg
Supporti per bombole Bottle supports	1 x 1/4" SAE 1 x 5/16" SAE
Manometro Manifold	Universale a 4 vie Universal 4 ways
Tubi con rubinetto Ball valve hoses	3 da 150 cm attacco 5/16" SAE 3 of 150 cm connection 5/16" SAE
Valigia Case	In resina con ruote Of plastic with wheels
Dimensioni valigia Case dimensions	600x380x430 mm
Adattatori inclusi Included adapters	1 x M5/16" SAE - F1/4" SAE con depressore, 1 x M5/16" SAE - F1/4" SAE 1 x M5/16" SAE - F1/4" SAE with depressor, 1 x M5/16" SAE - F1/4" SAE



Stazione di vuoto
Vacuum kit

42 L/MIN

Articolo/imballo Item/packing	KLIMABOXEASY 1 p
Pompa bistadio 2-stage vacuum pump	42 l/min
Gas utilizzabili Usable gas	R410A - R32
Manometro Manifold	Universale a 2 vie Universal 2 ways
Tubi con rubinetto Ball valve hoses	2 da 150 cm attacco 5/16" SAE 2 of 150 cm connection 5/16" SAE
Valigia Case	In tessuto con tracolla Of textile fabric with shoulder-belt
Dimensioni valigia Case dimensions	447x260x250 mm
Adattatori inclusi Included adapters	1 x M5/16" SAE - F1/4" SAE con depressore, 1 x M5/16" SAE - F1/4" SAE 1 x M5/16" SAE - F1/4" SAE with depressor, 1 x M5/16" SAE - F1/4" SAE





Pompa bistadio per alto vuoto
Two-stage vacuum pump

42 L/MIN

Articolo/imballo Item/packing	NPAV42 1 p
Portata nominale Swept volume	42 l/min
Vuoto finale Ultimate vacuum	2×10^{-1} Pa
Potenza motore Motor power	1/4 CV - HP
Alimentazione Power supply	220 - 240 V
Peso netto Net weight	4,3 Kg
Dimensioni Dimensions	240x93x200 mm
Accessori inclusi Included accessories	Vacuometro ed elettrovalvola Vacuum gauge and solenoid valve
Attacco per tubo Hose connection	Maschio da 1/4" SAE + adattatore Femmina 1/4" SAE/Maschio 5/16" SAE Male 1/4" SAE + adapter Female 1/4" SAE/Male 5/16" SAE
Uso Usage	La pompa è spedita vuota senza olio. Prima di avviare la pompa inserire l'olio e leggere attentamente le istruzioni d'uso. Carica d'olio 230 ml. The pump is supplied empty without oil. Before starting it, insert the oil and read carefully the use instructions. Oil tank 230 ml.



Pompa bistadio per alto vuoto
Two-stage vacuum pump

71 L/MIN

Articolo/imballo Item/packing	NPAV72 1 p
Portata nominale Swept volume	71 l/min
Vuoto finale Ultimate vacuum	2×10^{-1} Pa
Potenza motore Motor power	1/3 CV - HP
Alimentazione Power supply	220 - 240 V
Peso netto Net weight	7,8 Kg
Dimensioni Dimensions	280x115x230 mm
Accessori inclusi Included accessories	Vacuometro ed elettrovalvola Vacuum gauge and solenoid valve
Attacco per tubo Hose connection	Maschio da 1/4" SAE + adattatore Femmina 1/4" SAE/Maschio 5/16" SAE Male 1/4" SAE + adapter Female 1/4" SAE/Male 5/16" SAE
Uso Usage	La pompa è spedita vuota senza olio. Prima di avviare la pompa inserire l'olio e leggere attentamente le istruzioni d'uso. Carica d'olio 250 ml. The pump is supplied empty without oil. Before starting it, insert the oil and read carefully the use instructions. Oil tank 250 ml.





Pompa bistadio per alto vuoto Two-stage vacuum pump

128 L/MIN

Articolo/imballo Item/packing	NPAV120 1 p
Portata nominale Swept volume	128 l/min
Vuoto finale Ultimate vacuum	2×10^{-1} Pa
Potenza motore Motor power	1/2 CV - HP
Alimentazione Power supply	220 - 240 V
Peso netto Net weight	8,6 Kg
Dimensioni Dimensions	320x125x232 mm
Accessori inclusi Included accessories	Vacuometro ed elettrovalvola Vacuum gauge and solenoid valve
Attacco per tubo Hose connection	Maschio da 1/4" SAE + adattatore Femmina 1/4" SAE/Maschio 5/16" SAE Male 1/4" SAE + adapter Female 1/4" SAE/Male 5/16" SAE
Uso Usage	La pompa è spedita vuota senza olio. Prima di avviare la pompa inserire l'olio e leggere attentamente le istruzioni d'uso. Carica d'olio 280 ml. The pump is supplied empty without oil. Before starting it, insert the oil and read carefully the use instructions. Oil tank 280 ml.





Unità di recupero gas con separatore degli oli Gas recovery unit with oil separator

Articolo/imballo Item/packing	NRB32 1 p
Gas recuperabili Recoverable gas	Tutti i gas refrigeranti incluso R32 All refrigerant gas included R32
Filtro essiccatore Drier filter	Incluso Included
Potenza motore Motor power	1/2 CV - HP
Alimentazione Power supply	220V - 240V / 50-60Hz
Peso netto Net weight	15 Kg
Dimensioni Dimensions	485x220x365 mm
Capacità di recupero Recovery capacity	Vapore - Vapor 15,6 Kg/h Liquido - Liquid 111,0 Kg/h Push - Pull 373,2 Kg/h
Uso Usage	Recuperatore con motore a secco, funziona con i principali gas refrigeranti. Il prodotto è conforme alla procedura per unità di recupero e riciclo ISO 11650 Recovery unit with dry motor, it works with the common refrigerants. The product complied to procedure for the recovery and recycling units ISO 11650





Valigia per attrezzatura

Case for tools

Articolo/imballo Item/packing	NPAVT 1 p		NPAVC 1 p	
Materiale Material	Tessuto con tracolla With shoulder-bell		Plastica con ruote Plastic with wheels	
Dimensione Dimension	45x27xH25 cm		60x38xH43 cm	

Vacuometro di ricambio per pompe

Replacement vacuum gauge for pumps

Articolo/imballo Item/packing	NPV-V 1 p		NPV-V120	
Ø manometro Gauge diameter	Ø 70 mm		Ø 90 mm	
Per pompe For pumps	NPAV42 NPAV72		NPAV42 - NPAV72 NPAV120	

Elettrovalvola di ricambio per pompe

Replacement solenoid valve for pumps

Articolo/imballo Item/packing	NPV-E42 1 p		NPV-E120 1 p	
Per pompe For pumps	NPAV42		NPAV72 NPAV120	

Olio lubrificante per pompe

Lubricant oil for pumps

Articolo/imballo Item/packing	NOIL250 1 p	
Quantità Quantity	250 ml	

Utensile togliavalvole

Valve core remover

Articolo/imballo Item/packing	NCT 10 p	
Materiale Material	Alluminio Aluminium	

Kit estrattore valvole e accessori

Valve remover kit and accessories

Articolo/imballo Item/packing	NEV14-516 1 p	
Materiale estrattore Remover material	Alluminio Aluminium	
Contenuto Content	10 valvole - 10 percussori per tubi 10 guarnizioni da 1/4" e 10 da 5/16" 10 valve - 10 hose stickers 10 hose gasket 1/4" and 10 5/16"	

Rubinetto premi valvola Shut off valve

Articolo/imballo Item/packing	NRPV14 5/1 p	NRPV516 5/1 p
Dimensioni Dimensions	M1/4" SAE F1/4" SAE	M5/16" SAE F5/16" SAE
Descrizione Description	<p>Il rubinetto premi valvola permette la regolazione del flusso del refrigerante, evita il rischio di bruciateure delle dita al momento dello scollegamento e garantisce assenza di fughe durante la fase di collegamento o scollegamento della valvola</p> <p>The shut off valve allows the regulation of the flow of the refrigerant, avoids the risk of finger burns when disconnecting and guarantees the absence of leaks during the connection or disconnection of the valve</p>	

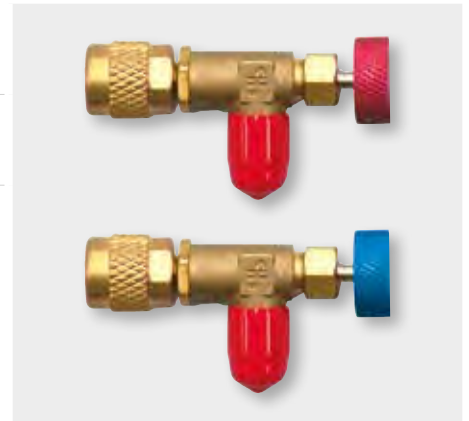

Rubinetto a sfera Ball valve

Articolo/imballo Item/packing	NA1414 5/1 p	NA14516 5/1 p	NA516 5/1 p
Dimensioni Dimensions	M1/4" SAE F1/4" SAE	M1/4" SAE F5/16" SAE	M5/16" SAE F5/16" SAE



Adattatore Adapter

Articolo/imballo Item/packing	NG14516 10/1 p	NG51614 10/1 p
Dimensioni Dimensions	M1/4" SAE F5/16" SAE	M5/16" SAE F1/4" SAE



Raccordo girevole a 90° Swivel connector 90°

Articolo/imballo Item/packing	N1414 10/1 p	N14516 10/1 p	N516 10/1 p
Dimensioni Dimensions	M1/4" SAE F1/4" SAE	M1/4" SAE F5/16" SAE	M5/16" SAE F5/16" SAE



Guarnizioni di ricambio in gomma Rubber replacement gasket

Articolo/imballo Item/packing	NGT516 10 p	NGT14 10 p
Per tubi For hoses	5/16" SAE	1/4" SAE



Tubo flessibile di carica con rubinetto a sfera
Flexible charging hose with shut-off ball valve



Articolo/imballo Item/packing	NBFR150-410 10/1 p	NRFR150-410 10/1 p	NYFR150-410 10/1 p
Attacchi Connections	5/16" SAE	5/16" SAE	5/16" SAE
Lunghezza Length	150 cm	150 cm	150 cm
Pressione di scoppio Bursting pressure	30 MPa	30 MPa	30 MPa
Colore Colour	Blu Blue	Rosso Red	Giallo Yellow

Vacuometro con rubinetto a sfera
Vacuum gauge with ball valve

Articolo/imballo Item/packing	NEM1V 1 p
Attacchi Connections	3 x 1/4" SAE + 2 x 5/16" SAE
Adattatore Adapter	F1/4" SAE M5/16" SAE
Materiale corpo Body material	Alluminio Aluminium



Gruppo manometrico a 4 vie
Manifold gauge 4 ways

Articolo/imballo Item/packing	NEM4-R32 1 p
Per gas For gas	R32 - R410A
Attacchi Connections	4 x 5/16" SAE
Materiale corpo Body material	Alluminio Aluminium



Kit gruppo manometrico a 4 vie
Manifold group kit 4 ways

Articolo/imballo Item/packing	NM4-R32 1 p	NM4U 1 p
Per gas For gas	R32 - R410A	R410A - R407C R422B - R134a
Attacchi Connections	4 x 5/16" SAE	
Lunghezza tubi Hoses length	3 x 150 cm con rubinetto 3 x 150 cm with ball valve	



Kit gruppo manometrico DIGITALE a 2 vie
DIGITAL manifold group kit 2 ways

Articolo/imballo Item/packing	NEMDIG 1 p
Per gas For gas	Per 82 tipi di refrigeranti incluso R32 For 82 kinds of refrigerants included R32
Attacchi Connections	2 x 1/4" SAE
Lunghezza tubi Hoses length	3 x 150 cm con rubinetto 3 x 150 cm with ball valve
Accessori inclusi Included accessories	2 sonde a termocoppia 2 thermocouples clamps



Descrizione
Description

Gruppo manometrico digitale a 2 vie con ampio display retroilluminato, misura 82 tipi di refrigerante tra cui i più comuni: R32 - R410A - R407C - R422B - R134a. In dotazione 2 sonde a termocoppia a morsetto per il rilevamento del surriscaldamento e sottoraffreddamento.

Unità di misura della pressione: MPA - KPA - BAR - PSI - KGF/CM - INHG

Unità di misura della temperatura: °C e °F

Temperatura di utilizzo: -10 °C + 50 °C

Pressione di utilizzo: da 0 a 50 BAR

Grado di protezione: IP42

Digital manifold gauge kit 2 ways with large backlight screen, suitable for 82 kinds of refrigerants including the most common: R32 - R410A - R407C - R422B - R134a. Supplied with 2 thermocouples clamps for measurement of superheat and supercooling.

Pressure unit: MPA - KPA - BAR - PSI - KGF/CM - INHG

Temperature unit: °C e °F

Operating temperature: -10 °C + 50 °C

Working pressure: from 0 to 50 BAR

Protection degree: IP42

Bilancia elettronica con valigetta
Electronic charging scale with case

Articolo/imballo Item/packing	NBE 1 p
Portata max Max load	50 Kg
Batterie Batteries	Incluse Included
Precisione Accuracy	+/- 2 gr (+/- 0,5 % lettura - reading)
Temperatura d'esercizio Working temperature	0°C / 50°C
Dimensione piatto Surface dimension	23x23 cm
Peso Weight	3,3 Kg



Supporto di carica universale
Universal charging support

Articolo/imballo Item/packing	NSBF 1 p	
Attacco bombole Bottle connection	1/4" SAE 5/16" SAE	
Attacco tubo Pipe connection	1/4" SAE 5/16" SAE	
Rubinetto Ball valve	Si Yes	

Mini bilancia elettronica
Mini electronic charging scale

Articolo/imballo Item/packing	NBE5 1 p	
Portata max Max load	5 Kg	
Batterie Batteries	Incluse Included	
Precisione Accuracy	1 gr	
Dimensione piatto Surface dimension	Ø 16,5 cm	

Kit bilancia elettronica e supporto di carica
Electronic scale and charging support kit

Articolo/imballo Item/packing	NBE5SB 1 p
Portata max Max load	5 Kg
Supporto di carica Charging support	Attacchi per 5/16" e 1/4" Connections for 5/16" and 1/4"
Batterie Batteries	Incluse Included
Precisione Accuracy	1 gr
Dimensione piatto Surface dimension	Ø 16,5 cm



Cercafughe spray Leak detector spray

Articolo/imballo Item/packing	NCS400 20 p
Quantità Quantity	400 ml
Descrizione Description	<p>Cercafughe spray per la ricerca delle perdite negli impianti di condizionamento. Adatto per impianti con qualsiasi gas aeriforme in pressione: ossigeno, idrogeno, aria, elio, azoto, argon, cloro, metano, anidride carbonica, ossido di etilene, ossido di metilene. NON tossico, NON corrosivo, NON sporca. Esplica un'azione sgrassante che permette il controllo anche nei punti sporchi quali filettature o cordoni di saldature.</p> <p>Leak detector spray to search for leaks in air conditioning systems. Suitable for systems with any pressure aeriform gas: oxygen, hydrogen, air, helium, nitrogen, argon, chlorine, methane, carbon dioxide, ethylene oxide, methylene oxide. NON-toxic, NON-corrosive, DO NOT dirty. Exerts a degreasing action that allows the control even in dirty spots like threads or weld beads.</p>



Cercafughe elettronico Electronic leak detector

Articolo Item	NCE 1 p
Sensibilità Sensibility	3 gr/anno 3 gr/year
Lunghezza sonda Probe length	34 cm
Durata sensore Sensor lifetime	30 ore 30 hours
Autonomia batteria Battery life	30 ore 30 hours
Allarme Alarm	Acustico e visivo Audible and visual
Tempo riscaldamento Warm up time	10"



Turafalle per impianti A/C Leak stoppers for A/C systems

Articolo/imballo Item/packing	NTF 1 p
Descrizione Description	<p>Ripara le perdite di gas refrigerante, della dimensione massima di 0,5 mm, in modo permanente. Ideale per installazioni preventive, riduce sensibilmente la rumorosità e le vibrazioni del compressore. Non danneggia i componenti degli impianti A/C e delle unità di recupero, il prodotto è compatibile con tutti i gas refrigeranti, incluso CFC, HFC e HCFC.</p> <p>It repairs refrigerant gas leaks, up to a maximum size of 0,5 mm, permanently. Ideal for preventive installations, it significantly reduces compressor noise and vibrations. It does not damage the components of A/C systems and recovery units, the product is compatible with all refrigerant gases, including CFCs, HFCs and HCFCs.</p>



Gas refrigerante in bombolette ricaricabili da 1 litro
Refrigerant gas in rechargeable bottles of 1 liter

Articolo/imballo Item/packing	NBF410A 6 p	NBF32 6 p	NBF407C 6 p	NBF422B 6 p
Tipo gas Gas type	R410A	R32	R407C	R422B
Quantità Quantity	0,800 Kg	0,780 Kg	0,850 Kg	0,850 Kg
Attacco Connection	5/16"	1/2"	1/4"	1/4"
Materiale bombola Bottle material	Acciaio Steel			
Tipologia Typology	Ricaricabili conformi UNI EN ISO10297 T-PED Rechargeable conform UNI EN ISO10297 T-PED			



Gas refrigerante in bombolette ricaricabili da 2 litri
Refrigerant gas in rechargeable bottles of 2 liters

Articolo/imballo Item/packing	NBF410-02 6 p	NBF32-02 6 p
Tipo gas Gas type	R410A	R32
Quantità Quantity	1,9 Kg	1,8 Kg
Attacco Connection	5/16"	1/2"
Materiale bombola Bottle material	Acciaio Steel	
Tipologia Typology	Ricaricabili conformi UNI EN ISO10297 T-PED Rechargeable conform UNI EN ISO10297 T-PED	



Adattatore per bombole gas R32
Adapter for R32 gas bottle

Articolo/imballo Item/packing	NRR32 5 p	NRR32-516 5 p
Attacchi Connection	F1/2" - M1/4"	F1/2" - M5/16"

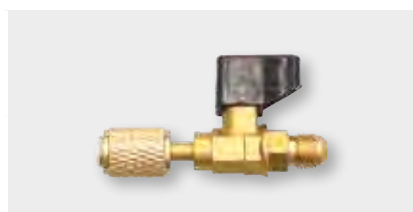

Gas refrigerante in bombole ricaricabili da 10 litri
Refrigerant gas in rechargeable bottles of 10 liters

Articolo/imballo Item/packing	NBFR32-13 1 p
Tipo gas Gas type	R32
Quantità Quantity	9,0 Kg
Attacco Connection	1/2"
Materiale Material	Acciaio Steel
Tipologia Typology	Ricaricabili conformi UNI EN ISO10297 T-PED Rechargeable conform UNI EN ISO10297 T-PED



Bombola per recupero gas refrigerante
Gas recovery bottle

Articolo/imballo Item/packing	NRF410-13 1 p
Capacità Capacity	12,5 L
Pressione Pression	46 Bar
Materiale Material	Acciaio Steel
Tipologia Typology	Ricaricabili Rechargeable
Rubinetto Cock	2 vie 2 way



Termometro digitale con sonda estraibile
Digital thermometer with extractable probe

Articolo/imballo Item/packing	NPD03D 1 p	
Lunghezza sonda Probe length	11 cm	
Range temperatura Temperature range	-50 / +300 °C	

Termometro digitale con custodia
Digital thermometer with casing protection

Articolo/imballo Item/packing	NPD03 1 p	
Lunghezza sonda Probe length	11 cm	
Range temperatura Temperature range	-40 / +300 °C	



Sistemi di lavaggio e pulitori Washing systems and cleaners

Kit per lavaggio linee frigorifere Kit for washing refrigeration lines

Articolo/imballo Item/packing	NSL 1 p
Composizione KIT KIT composition	1 bombola vuota da 1 litro per detergente 1 tubo flessibile da 90 cm 1 pistola di erogazione 1 empty bottle 1 liter for detergent 1 flexible pipe of 90 cm 1 spraying gun



Liquido per lavaggio linee frigorifere Liquid for washing refrigeration lines

Articolo/imballo Item/packing	NFL 12 p
Quantità Quantity	1 L



Detergente per lavaggi interni
Detergent for internal flushing

Articolo/imballo Item/packing	NLI 12 p
Descrizione Description	<p>Soluzione semplice e veloce per lavare piccole linee frigorifere Elevata pressione di lavaggio 8bar/116psi In bomboletta spray da 600 ml - Fornito con cono in gomma</p> <p>Quick and easy solution for washing small refrigeration lines High washing pressure 8bar/116psi 600 ml spray can - Supplied with rubber cone</p>



Kit di pressurizzazione
Nitrogen pressure kit

Articolo/imballo Item/packing	NKBA 1 p
Composizione KIT KIT composition	<p>Regolatore di pressione azoto certificato 825ARS-40 N2 con bilanciatore di pressione in uscita, pressione in entrata 220 Bar, pressione in uscita 50 Bar Manometro Ø 80 mm, classe 1.0, settori definiti, indice di posizionamento e vite di regolazione Adattatori: 1 M 1/4" SAE - F 5/16" SAE, 1 adattatore bombola Tubo flessibile da 25 cm Bombola azoto 100 litri compressi a 110 Bar</p> <p>Nitrogen pressure regulator, certification 825ARS-40 N2 with pressure balancer, inlet pressure 220 Bar, outlet pressure 50 Bar Gauge Ø 80 mm, class 1.0, with defined sectors, positioning indicator and calibration screw Adapters: 1 M 1/4" SAE - F 5/16" SAE, 1 bottle adapter. Flexible hose length 25 cm Nitrogen bottle 100 liters compressed to 110 Bar</p>



Accessori di ricambio per Kit NKBA
Replacement accessories for NKBA kit

Articolo/imballo Item/packing	NFM 1 p	NRP 1 p	NBA 6 p
Descrizione Description	Manometro di ricambio Replacement gauge	Regolatore di pressione Pressure regulator	Bomboletta AZOTO 100 litri compressi a 110 bar Nitrogen bottle 100 liters compressed at 110 bar

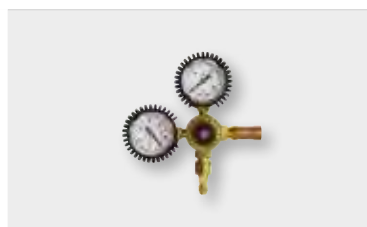
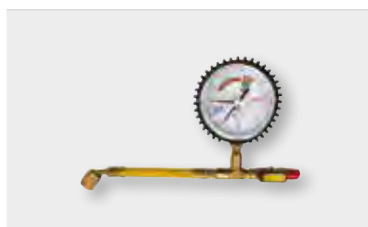

Pulitori per climatizzatori

Air conditioner cleaners

<p>Articolo/imballo Item/packing</p>	<p>NPF1 6 p</p>	
<p>Descrizione Description</p>	<p>Pulitore per i filtri dei Climatizzatori. La sua azione, rapida ed efficace, è ottimale per la manutenzione e la pulizia dei filtri delle unità interne. Rimuove facilmente smog, polvere, muffe e contaminanti microbici, le cause dei cattivi odori e lo sporco che l'acqua non può rimuovere. Idoneo per il piano HACCP. Emana una piacevole profumazione. Flacone da 1 litro.</p> <p>Cleaner for air conditioner filters. Its fast and effective action is optimal for the maintenance and cleaning of indoor unit filters. It easily removes smog, dust, mold and microbial contaminants, the causes of bad odors and dirt that water cannot remove. Suitable for HACCP plan. It exudes a pleasant fragrance. 1 litre bottle.</p>	
<p>Articolo/imballo Item/packing</p>	<p>NIP1 6 p</p>	
<p>Descrizione Description</p>	<p>Pulitore Igienizzante per Climatizzatori. La sua azione, rapida ed efficace, è ottimale per la manutenzione completa delle unità interne. Rimuove infatti residui organici e sporco accumulatosi nel tempo, rallentandone la ricomparsa. Ha un'intensa azione purificante e non presenta aggressività per le superfici e l'operatore. Il prodotto non necessita di risciacquo ed è idoneo per il piano HACCP. Flacone da 1 litro.</p> <p>Sanitizing Cleaner for Air Conditioners. Its action, fast and effective, is optimal for the complete maintenance of indoor units. In fact, it removes organic residues and dirt that has accumulated over time, slowing down their reappearance. It has an intense purifying action and is not aggressive for surfaces and the operator. The product does not require rinsing and is suitable for the HACCP plan. 1 litre bottle.</p>	
<p>Articolo/imballo Item/packing</p>	<p>NPA1 6 p</p>	
<p>Descrizione Description</p>	<p>Pulitore Alcalino ad azione Anticorrosiva per Climatizzatori. Specifico per la pulizia delle unità interne che necessitano di un'azione disincrostante importante. La sua composizione fortemente alcalina permette di agire come un acido rimuovendo sporcizia di origine salina molto ostinata. È il prodotto ideale per ripristinare impianti trascurati o soggetti a forte aggressione ambientale quali evaporatori installati in cucine, produzioni alimentari, aree frittura o macelli. Flacone da 1 litro.</p> <p>Alkaline Cleaner with Anti-Corrosion Action for Air Conditioners. Specific for cleaning indoor units that require a significant descaling action. Its strongly alkaline composition allows it to act as an acid, removing very stubborn saline dirt. It is the ideal product for restoring neglected systems or systems subject to strong environmental aggression such as evaporators installed in kitchens, food production, frying areas or slaughterhouses. 1 litre bottle.</p>	

Igienizzanti per climatizzatori Sanitizers for air conditioners

Articolo/imballo Item/packing	NI400 20 p	NIL400 12 p
Tipo Type	Schiumogeno Foaming	Liquido Liquid
Descrizione Description	<p>Igienizzante per Climatizzatori. Per igienizzare e togliere cattivi odori. Ideale per eliminare muffe, batteri o germi da filtri, condutture e pacchi alettati. Previene disturbi da allergie attraverso l'eliminazione di batteri e microrganismi. Non è tossico nè corrosivo e non decolora le parti trattate. Adatto per impianti fissi e per auto. Bomboletta spray da 400 ml</p> <p>Sanitizer for Air Conditioners. To sanitize and remove bad odors. Ideal for removing mold, bacteria or germs from filters, ducts and finned packs. It prevents allergy disorders through the elimination of bacteria and microorganisms. It is non-toxic or corrosive and does not discolor the treated parts. Suitable for fixed and car installations. 400 ml spray can</p>	



Disinfettante Concentrato Battericida e Levuricida Concentrated Disinfectant Bactericide and Levuricide

Articolo/imballo Item/packing	NIS250 24 p	NIS1 6 p
Quantità Quantity	Flacone da 250 ml 250 ml bottle	Flacone da 1 litro 1 liter bottle
Descrizione Description	<p>Disinfettante Concentrato Battericida e Levuricida È un disinfettante a presidio medico chirurgico (n° 20145) sviluppato appositamente per la pulizia di climatizzatori, canali di areazione e di tutte le superfici dove si desidera avere un profondo livello di disinfezione. Agisce in soli 5 minuti dall'applicazione ed è idoneo per il piano HACCP. È un prodotto CONCENTRATO quindi può essere diluito ma se utilizzato puro ha un'azione ancora più profonda ed efficace. Testato contro i virus di influenza, epatite B/C, HIV, rota virus, noro virus ed ebola virus. Per i batteri supera i test: EN1276 - EN 13697 Per le muffe supera il test: EN 13697 Può essere applicato sia in forma liquida che schiumosa grazie allo speciale trigger. Non rilascia né odori né residui. ATTENZIONE: non utilizzare su superfici a contatto con alimenti.</p> <p>Concentrated Disinfectant Bactericide and Levuricide It is a medical-surgical disinfectant (n° 20145) developed specifically for cleaning air conditioners, ventilation channels and all surfaces where you want to have a deep level of disinfection. It works in just 5 minutes from application and is eligible for the HACCP plan. It is a CONCENTRATED product so it can be diluted but if used pure it has an even deeper and more effective action. Tested against FLU, hepatitis B/C, HIV, rota virus, noro virus and Ebola virus. For bacteria it passes the tests: EN1276 - EN 13697 For molds it passes the test: EN 13697 It can be applied in both liquid and foamy form thanks to the special trigger. It does not release odors or residues. CAUTION: Do not use on food contact surfaces.</p>	



Pulitori per Condensatori (Unità esterne)

Condenser Cleaners (Outdoor Units)

<p>Articolo/imballo Item/packing</p>	<p>NSC1 6 p</p>	
<p>Descrizione Description</p>	<p>Pulitore alcalino per condensatori. Grazie alla sua formulazione, sgrassa in maniera efficace rimuovendo anche la sporcizia più ostinata. Può essere diluito in base al tipo di sporco da rimuovere, ma più il prodotto verrà utilizzato concentrato, maggiore sarà la sua efficacia. È consigliato evitare il contatto con parti verniciate. Ideale per ripristinare l'efficienza dello scambio termico del condensatore, rimuove residui organici ostinati: grasso, polvere, polline e smog. Flacone da 1 litro</p> <p>Alkaline cleaner for condenser. Thanks to its formulation, it effectively degreases by removing even the most stubborn dirt. It can be diluted according to the type of dirt to be removed, but the more concentrated the product is used, the more effective it will be. It is recommended to avoid contact with painted parts. Ideal for restoring the efficiency of the condenser's heat exchange, it removes stubborn organic residues: grease, dust, pollen and smog. 1 litre bottle.</p>	
<p>Articolo/imballo Item/packing</p>	<p>NSA1 6 p</p>	
<p>Descrizione Description</p>	<p>Pulitore acido per condensatori. Grazie alla sua formulazione, disincrosta in modo efficace la superficie trattata, rimuovendo anche i depositi più ostinati. È particolarmente indicato per sciogliere lo sporco depositato nelle fessure delle batterie alettate. Può essere diluito con acqua in base al tipo di incrostazione da rimuovere. Più il prodotto verrà utilizzato concentrato, maggiore sarà la sua efficacia. È consigliato evitare il contatto con parti verniciate. Risciacquare abbondantemente. Flacone da 1 litro</p> <p>Acid cleaner for condensers. Thanks to its formulation, it effectively descales the treated surface, removing even the most stubborn deposits. It is particularly suitable for dissolving dirt deposited in the cracks of finned coils. It can be diluted with water depending on the type of scale to be removed. The more concentrated the product is used, the more effective it will be. It is recommended to avoid contact with painted parts. Rinse thoroughly. 1 litre bottle.</p>	
<p>Articolo/imballo Item/packing</p>	<p>NTA1 6 p</p>	
<p>Descrizione Description</p>	<p>Trattamento protettivo per impianti installati in aree fortemente ossidanti (località di mare, luoghi fortemente inquinati), dove il sale e le piogge acide riducono in modo sensibile la vita di un condensatore. Spruzzare sul condensatore precedentemente trattato con un prodotto acido o alcalino. Forma un microfilm che mantiene inalterato lo scambio termico dell'unità condensante, riducendo la capacità degli agenti contaminanti come il sale e lo smog di intaccare le superfici.</p> <p>Protective treatment for systems installed in highly oxidizing areas (seaside resorts, heavily polluted places), where salt and acid rain significantly reduce the life of a condenser. Spray on the condenser previously treated with an acidic or alkaline product. It forms a microfilm that maintains the heat exchange of the condensing unit, reducing the ability of contaminants such as salt and smog to affect surfaces.</p>	





Arnocanali S.p.A. © 2022
Via G. Di Vittorio, 34/36
50067 Rignano sull'Arno
Firenze - Toscana (IT)
Telefono +39 055 8349181
Web: www.arnocanali.it